



AI ToF People Counting Sensor

VS133

User Guide



Safety Precautions

Milesight will not shoulder responsibility for any loss or damage resulting from not following the instructions of this operating guide.

- ❖ Though the device is compliant with Class 1 (IEC/EN 60825-1:2014), please **DO NOT** look at the ToF sensor too close and directly.
- ❖ The device must not be disassembled or remodeled in any way.
- ❖ To avoid risk of fire and electric shock, do keep the product away from rain and moisture before installation.
- ❖ Do not place the device where the temperature is below/above the operating range.
- ❖ Do not touch components which may be hot.
- ❖ The device must never be subjected to shocks or impacts.
- ❖ Make sure the device is firmly fixed when installing.
- ❖ Do not expose the device to where laser beam equipment is used.
- ❖ Use a soft, dry cloth to clean the lens of the device.

Declaration of Conformity

VS133 is in conformity with the essential requirements and other relevant provisions of the CE, FCC, and RoHS.



Copyright © 2011-2023 Milesight. All rights reserved.

All information in this guide is protected by copyright law. Whereby, no organization or individual shall copy or reproduce the whole or part of this user guide by any means without written authorization from Xiamen Milesight IoT Co., Ltd.

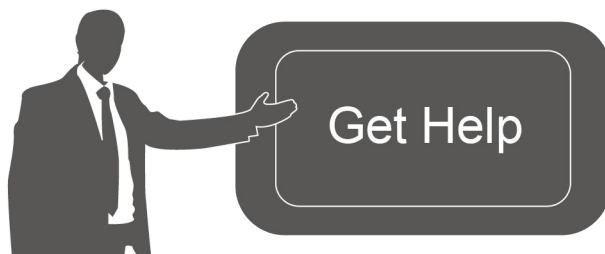

For assistance, please contact

Milesight technical support:

Email: iot.support@milesight.com

Support Portal: support.milesight-iot.com

Tel: 86-592-5085280

Fax: 86-592-5023065

Address: Building C09, Software Park
Phase III, Xiamen 361024,
China

Revision History

Date	Doc Version	Description
May 24, 2023	V 1.0	Initial version

Contents

1. Product Introduction	5
1.1 Overview	5
1.2 Key Features	5
2. Hardware Introduction	5
2.1 Packing List	5
2.2 Hardware Overview	6
2.3 Button and LED Indicators	7
2.4 Dimensions (mm)	7
3. Power Supply	7
4. Access the Sensor	8
4.1 Access with Wi-Fi (LoRaWAN® Version)	8
4.2 Access with Ethernet (PoE Version)	9
5. Operation Guide	10
5.1 Dashboard	10
5.2 Rule	11
5.3 Communication	14
5.3.1 WLAN (LoRaWAN® Version)	14
5.3.2 LoRa (LoRaWAN® Version)	15
5.3.3 Ethernet (PoE Version)	18
5.4 Report	19
5.5 System	20
5.5.1 Device Info	20
5.5.2 User	21
5.5.3 Time Configuration	22
5.5.4 Remote Management (PoE Version)	23
5.5.5 System Maintenance	23
6. Installation Instruction	24
6.1 Installation Height	25
6.2 Covered Detection Area	25
6.3 Environment Requirements	25
6.4 Installation	26
6.5 Factors Affecting Accuracy	29
7. Communication Protocol	29
7.1 LoRaWAN® Version	29
7.2 PoE Version	32

1. Product Introduction

1.1 Overview

VS133 is a sensor that uses second-generation ToF technology to accurately count people. This technology provides more precise depth maps and longer detection distances while maintaining an excellent privacy protection rate. The advanced ToF technology combined with an AI algorithm enables the sensor to handle complex scenes and distinguish non-human objects with up to 99.8% accuracy. The VS133 sensor can be used in conjunction with the Milesight LoRaWAN® gateways and the Milesight IoT Cloud, as well as with the PoE version VS133-P, which allows for easy Ethernet connectivity and different data transmission options. With easy installation, the VS133 and VS133-P sensors are ideal for entrances or corridors in retail stores, malls, offices, subways, and other locations.

1.2 Key Features

- Up to 99.8% accuracy combining the 2nd generation ToF technology and AI algorithm
- Allow to collect people counting data by differentiating between children and adults and detecting staffs via identification features for clearer people analysis
- Wider field angle to obtain longer-distance depth maps and cover a larger area
- Working well even in low-light or completely dark environments with great lighting adaptability
- Free from privacy concerns without image capturing
- Smart U-turn counting to filter redundant counting of people wandering in the area
- High compatibility of data transmission either from LoRaWAN® or Ethernet port (HTTP/MQTT/CGI)
- Various serial ports are equipped in the VS133 PoE version
- 4GB flash storage to store counting data locally and securely
- Easy configuration via Wi-Fi or Ethernet port for web GUI configuration
- Function well with standard LoRaWAN® gateways and network servers
- Quick and easy management with Milesight IoT Cloud or Milesight DeviceHub

2. Hardware Introduction

2.1 Packing List

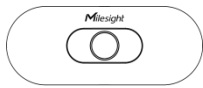

1 × VS133 Device



4 × Ceiling Mounting Kits



1 × Mounting Sticker



8 × Staff Tags

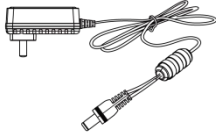

1 × Power Adapter (LoRaWAN® Version Only)



1 × Multi-interface (PoE Version Only)



1 × Warranty Card



1 × Quick Guide

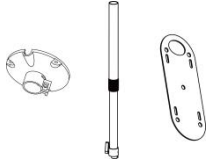

1 × VB01 Multifunctional Bracket Kit(Optional)



If any of the above items is missing or damaged, please contact your sales representative.

2.2 Hardware Overview

LoRaWAN® Version

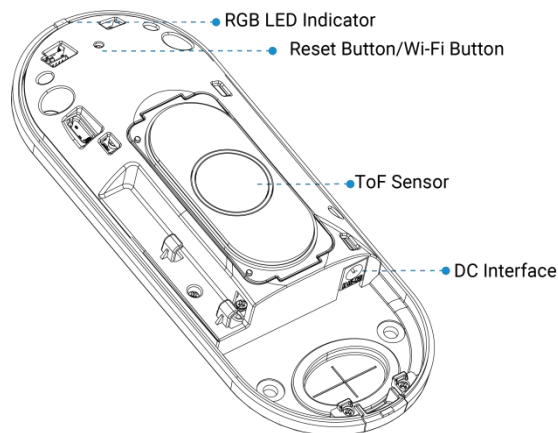

PoE Version

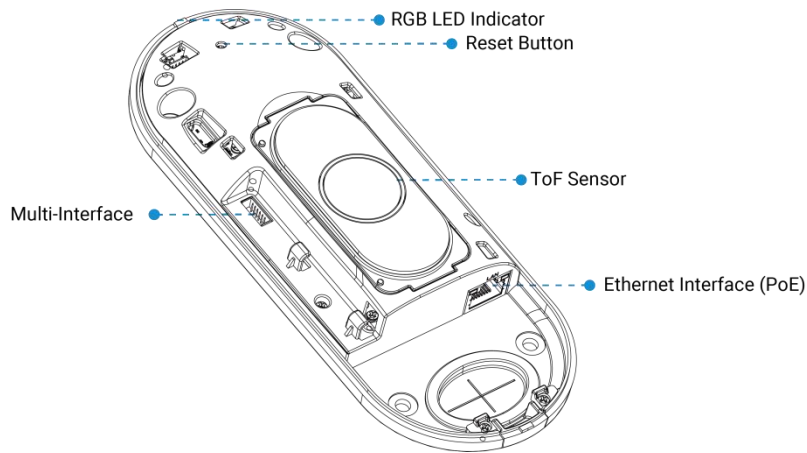

2.3 Button and LED Indicators

Function	Action	LED Indication
Turn On/Off Wi-Fi (LoRaWAN® Version Only)	Press and hold the button for more than 3 seconds.	Blue blinks 3s Wi-Fi on: Blue on Wi-Fi off: Green on
Reset to Factory Default	Press and hold the reset button for more than 10 seconds.	Green Blinks.

2.4 Dimensions (mm)

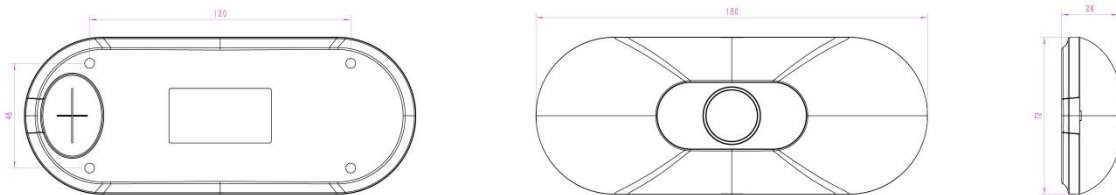

3. Power Supply

LoRaWAN® Version:

VS133 can be powered by power adapter (12VDC, 2A).

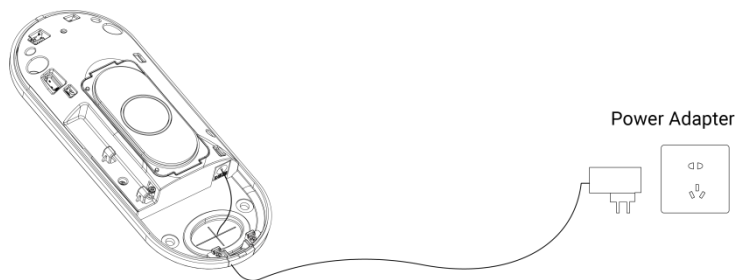

PoE Version:

VS133-P can be powered by 802.3at standard PoE. Choose one of the following methods to power up the device.

- **Powered by a PoE Switch**

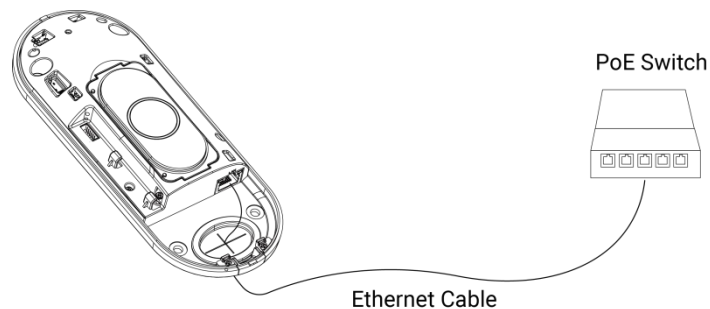

- **Powered by a PoE Injector**

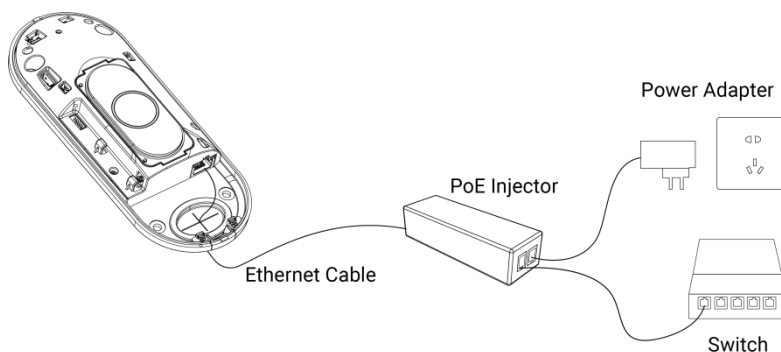

4. Access the Sensor

VS133 sensor provides user-friendly web GUI for configuration and users can access it via Wi-Fi connection or Ethernet port. The recommended browsers are Chrome and Microsoft Edge. The default IP of Ethernet port is **192.168.5.220**, the default IP of Wi-Fi is **192.168.1.1**, and default SSID is **People Counter_XXXXXX**.

Note: The default information can be found on the label.

4.1 Access with Wi-Fi (LoRaWAN® Version)

Step 1: Power on the device.

Step 2: Enable the Wireless Network Connection on your computer and search for corresponding access point, then connect computer to this access point.

Step 3: Open the Browser and type 192.168.1.1 to access the web GUI.

Step 4: Select the language.

Step 5: Users need to set the password and three security questions when using the sensor for the first time (three questions can be skipped by refreshing webpage). After configuration, log in with username (admin) and custom password.

Note:

1) Password must be 8 to 16 characters long, which contains at least two kinds or more in combination with numbers, lowercase letters, uppercase letters and special characters .

2) You can click the "forgot password" in login page to reset the password by answering three security questions when you forget the password if you set the security questions in advance.

English >

Activation

Username

Password

Confirm

At least:

- 8 characters
- 2 types of characters: Number, letter and symbol

>

English >

Set Security Questions

Security Question1

Answer1

Security Question2

Answer2

Security Question3

Answer3

✓

4.2 Access with Ethernet (PoE Version)

Step 1: Power on the device and connect the Ethernet port to a PC.

Step 2: Change the IP address of computer to 192.168.5.0 segment as below:

- Go to **Start** → **Control Panel** → **Network and Internet** → **Network and Sharing Center** → **Ethernet** → **Properties** → **Internet Protocol Version 4 (TCP/IPv4)**.

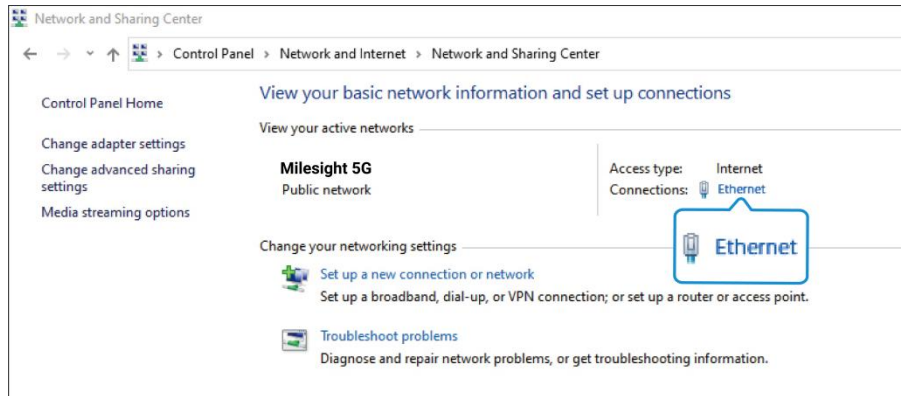

- b. Enter an IP address that in the same segment with sensor (e.g. 192.168.5.61, but please note that this IP address shall not conflict with the IP address on the existing network);

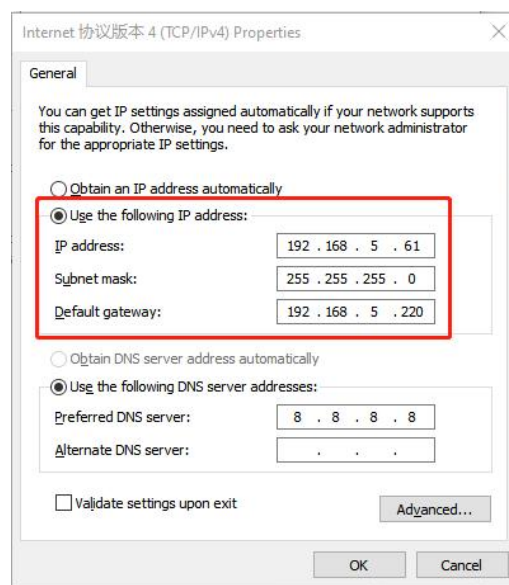

Step 3: Open the Browser and type 192.168.5.220 to access the web GUI. After logging on web GUI successfully, user is allowed to view configuration page.

5. Operation Guide

5.1 Dashboard

After logging on to the device web GUI successfully, user is allowed to view live video as follows.

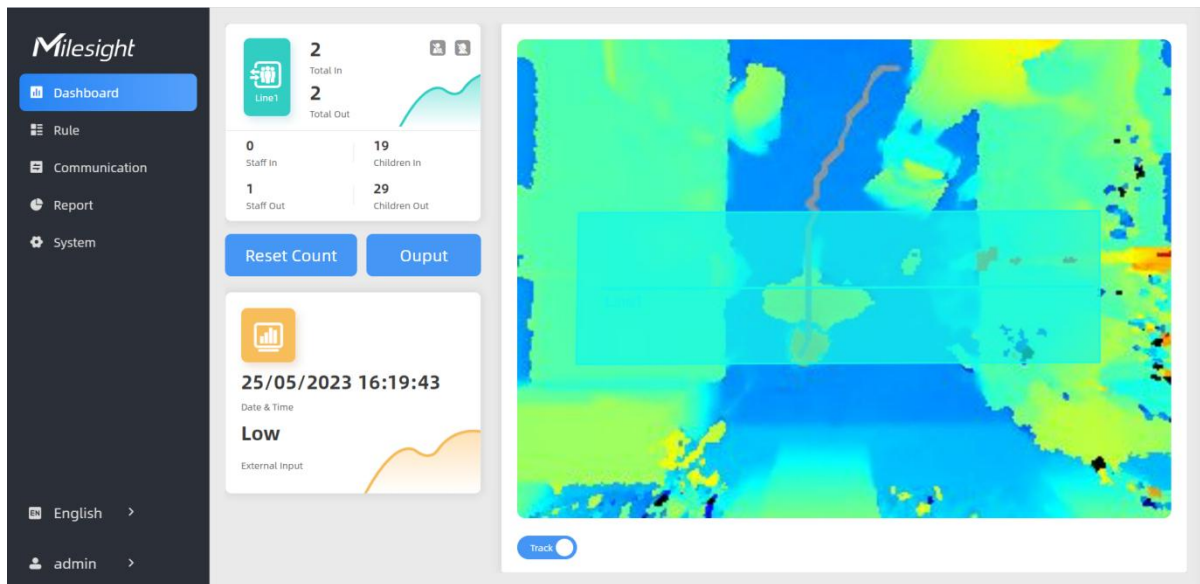

Parameters	Description
Reset Count	Clear accumulated entrance and exit people counting values.
Output (PoE Version)	Click to output a 5s high level signal from alarm out interface. Alarm Output: dry contact, output=tow contacts closure
Track	When enabled, there is tracking line when people pass the detection area.

5.2 Rule

Draw Detection Lines

Users can draw detection lines to record the people count values which indicate the number of people enter or exit.

Step 1: Click **Draw Detection Lines**.

Step 2: Left-click to start drawing and drag the mouse to draw a line, left-click again to continue drawing a different direction edge and right-click the mouse to complete the drawing. The line can be dragged to adjust the location and length. One device supports at most 4 broken lines with maximum 4 segments each.

Step 3: If users need to delete the line, Click **Draw Detection Lines**, and select the line which need to be deleted, then click **Clear This Line** or click **Clear All**.

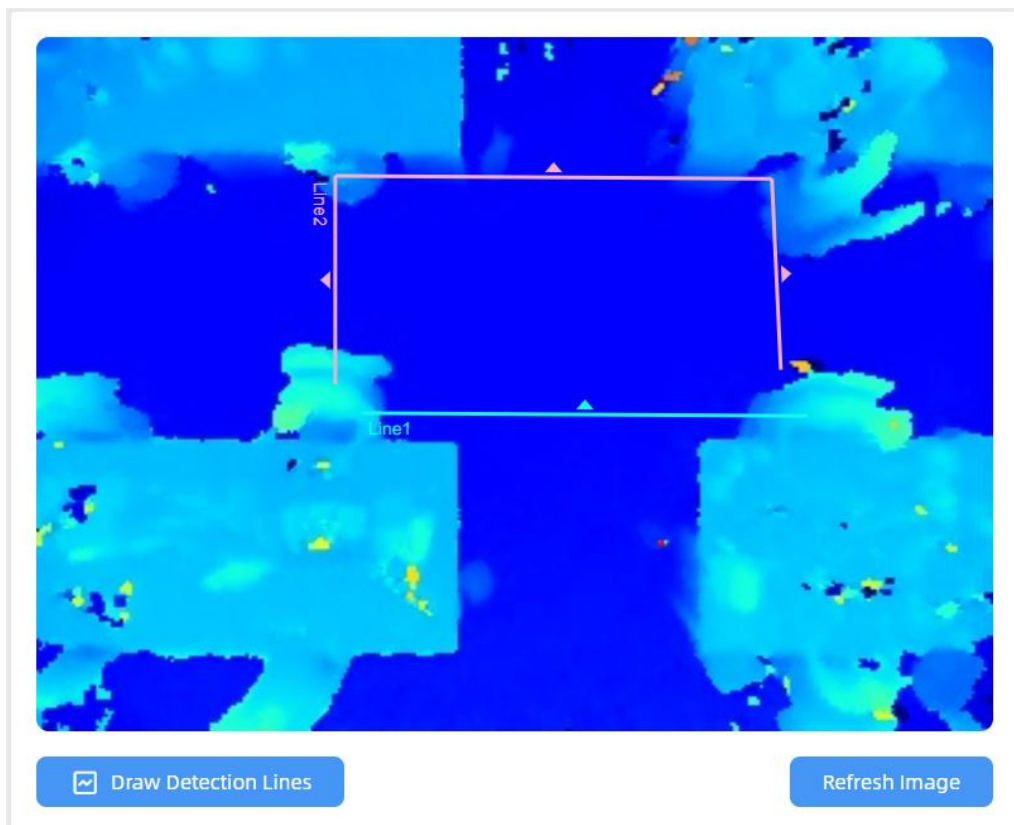

Note:

1) The arrow direction of the detection line depends on your drawing direction.

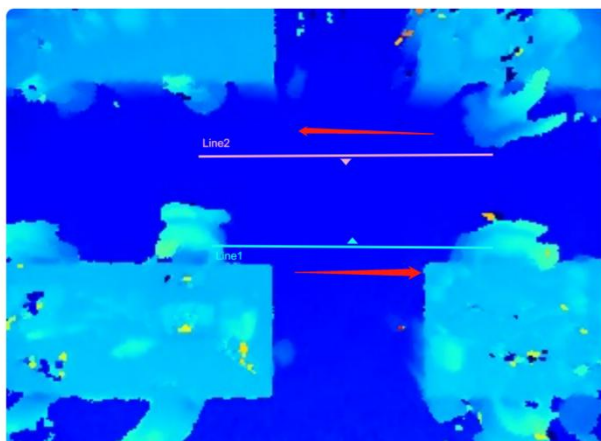

2) Ensure that the detected target can pass through the detection line completely. It's recommended that the detection line is perpendicular to the In/Out direction and on the center of the detection area without other objects around.

3) A redundant identification area needed to be left on both sides of the detection line for the target. This is to ensure that the sensor has stable recognition and tracking of this target before it passes the detection line, which will make the detection and count more accurate.

Rule Configuration

Users can set the rules to ensure accurate counting.

Deployment Parameter

Installation Height <small>mm(2000~3500)</small>	<input type="text" value="3050"/>
Max. Target Height <small>mm(500~3000)</small>	<input type="text" value="2000"/>
Min. Target Height <small>mm(500~3000)</small>	<input type="text" value="1000"/>
Child Filter Height <small>mm(500~3000)</small>	<input type="text" value="1900"/>

×
✓

Counting Strategy

U-turns Filtering	<input checked="" type="checkbox"/>
Draw U-turns Areas ⓘ	Draw
Children Distinction	<input checked="" type="checkbox"/>
Staff Detection ⓘ	<input type="checkbox"/>
Input Enable Count Externally	<input checked="" type="checkbox"/>
Current Status	Low ↻
Trigger Status	High Status Low Status

Parameters	Description
Installation Height	Set the device installation height.
Max Target Height	Set the maximum target height, then the device will ignore the objects higher than this setting.
Min Target Height	Set the minimum target height, then the device will ignore the object shorter than this setting.
Child Filter Height	Set the max child height when children distinction feature is enabled.
U-turns Filtering	When enabled, it allows to draw an area for every line and the device will count the In and Out values only when people cross along this area. Users can left-click to start the drawing and add edges for this area, then right-click to stop drawing.
Children Distinction	The device will detect the people shorter than child filter height as children.
Staff Detection	The device will detect the people who wear reflective stripe as staff tags on

	the visible upper body (neck, shoulders, etc.) as staffs. Reflective stripe requirements: width > 2cm, 500 cd/lux.m ²
Input Enable Count Externally (PoE Version)	Only when alarm input status is the same as the preset trigger status, will the device count the data. Alarm Input: dry contact, low level=two contacts disconnected, high level=tow contacts closure

Note: Due to the error in ToF distance measurement (0.035 m), the Max Target Height should be set as maximum pedestrian height plus 0.035 m and the Min Target Height as minimal pedestrian height minus 0.035 m in the actual applications. For example, if the pedestrian height is 1.6 m to 1.8 m, the Max and Min Target Height should be configured as 1.835 m and 1.565 m respectively.

Report Strategy

Trigger Report

Periodic Report

Period
min(1~1080)

Parameters	Description
Trigger Report (PoE Version)	Report the people counting data immediately when the in/out value changes.
Periodic Report	Report the people counting data periodically.
Period	Set the period of reporting periodic report. Range: 1-1080 mins, default: 10 mins

5.3 Communication

5.3.1 WLAN (LoRaWAN® Version)

VS133 supports wlan feature to work as AP mode to configure device and it can not connect to other access point.

WLAN

Enable WLAN

WLAN Settings

Wi-Fi SSID: People Counter_10E136

Protocol: 802.11n (2.4G)

Bandwidth: 20MHz

Channel: Auto

Security Mode: WPA-PSK/WPA2-PSK

Cipher: AES/TKIP

Wi-Fi Password:

Parameters	Description
Enable WLAN	Enable Wi-Fi feature. If disabled, users can use button or LoRaWAN [®] downlink command to enable it.
Wi-Fi SSID	The unique name for this device Wi-Fi access point.
Protocol	802.11b (2.4 GHz), 802.11g (2.4 GHz), 802.11n (2.4 GHz) are optional.
Bandwidth	20 MHz or 40 MHz are optional.
Channel	Select the wireless channel. Auto, 1,...11 are optional.
Security Mode	No Encryption, WPA-PSK, WPA2-PSK and WPA-PSK/WPA2-PSK are optional.
Cipher	AES, TKIP, AES/TKIP are optional.
Wi-Fi Password	Customize the password when security mode is not No Encryption.

5.3.2 LoRa (LoRaWAN[®] Version)

LoRa settings are used for configuring the transmission parameters in LoRaWAN[®] network.

Device LoRa Info.

LoRa Status

De-activated

Device EUI

24E1246936202833

LoRaWAN® Settings

APP EUI	24E124C0002A0001
Application Port <small>(1~223)</small>	85
Join Type	OTAA
Application Key
Rejoin Mode	<input checked="" type="checkbox"/>
Number of Detection <small>(4~32)</small>	8
LoRaWAN® Version	V1.0.3
Region	US915
RX2 Data Rate	DR0 (SF12, 125k)
RX2 Frequency <small>MHz(923.3~927.5)</small>	923.3
Spreading Factor	SF10-DR0
Enabled Channel Index ^①	0-71

Channel List

Index	Frequency <small>MHz</small>
0-15	902.3-905.3
16-31	905.5-908.5
32-47	908.7-911.7
48-63	911.9-914.9
64-71	903-914.2

LoRa Working Mode

Confirm Mode

ADR

Parameters	Description
LoRa Status	LoRaWAN® network joining status of this device.
Device EUI	Unique ID of the device, which can also be found on the label.
App EUI	The Default App EUI is 24E124C0002A0001.
Application Port	The port used for sending and receiving data, default port is 85.

Join Type	OTAA and ABP mode are available.
Application Key	Appkey for OTAA mode, the default key is 5572404C696E6B4C6F52613230313823.
Device Address	DevAddr for ABP mode, the default address is the 5 th to 12 th digits of SN.
Network Session Key	Nwkskey for ABP mode, the default key is 5572404C696E6B4C6F52613230313823.
Application Session Key	Appskey for ABP mode, the default key is 5572404C696E6B4C6F52613230313823.
Rejoin Mode	<p>Reporting interval \leq 35 mins: the device will send a specific number of LinkCheckReq MAC packets to the network server with periodic or threshold uplinks everytime more than 25~35 mins passes to validate connectivity; If there is no response, the device will re-join the network.</p> <p>Reporting interval $>$ 35 mins: the device will send a specific number of LinkCheckReq MAC packets to the network server every reporting interval to validate connectivity; If there is no response, the device will re-join the network.</p>
Number of Detection	<p>When rejoin mode is enabled, set the number of detection.</p> <p>Note: the actual sending number is Number of Detection + 1.</p>
LoRaWAN [®] Version	V1.0.2, V1.0.3 are available.
Region	Frequency plan of this device.
RX2 Data Rate	RX2 data rate to receive downlinks.
RX2 Frequency	RX2 frequency to receive downlinks.
Spreading Factor	If ADR is disabled, the device will send data via this spreading factor.
Channel	<p>Select the channel from channel list or enter the index to select the frequency channel.</p> <p>Index examples:</p> <p>1, 40: Enabling Channel 1 and Channel 40</p> <p>1-40: Enabling Channel 1 to Channel 40</p> <p>1-40, 60: Enabling Channel 1 to Channel 40 and Channel 60</p> <p>All: Enabling all channels</p> <p>Null: Indicates that all channels are disabled</p>
Confirm Mode	If the device does not receive ACK packet from network server, it will resend data once.
ADR	Allow network server to adjust data rate of the device.

Note:

- 1) Please contact sales for device EUI list if there are many units.
- 2) Please contact sales if you need random App keys before purchase.
- 3) Only OTAA mode supports rejoin mode.
- 4) Select OTAA mode when you connect device to Milesight IoT Cloud.

5.3.3 Ethernet (PoE Version)

VS133 provides a Ethernet port for wired access. Besides, users can get the people counting data or configure the device via CGI. For CGI document, please contact with Milesight IoT support: iot.support@milesight.com.

TCP/IP

IP Address Test

Subnet Mask

Default Gateway

Primary DNS Server

Secondary DNS Server

×
✓

Parameters	Description
IP Address	Set the IPv4 address of the Ethernet port, the default IP is 192.168.5.220.
Subnet Netmask	Set the Netmask for the Ethernet port.
Default Gateway	Set the gateway for the Ethernet port's IPv4 address.
Primary DNS Server	Set the primary IPv4 DNS server.
Secondary DNS Server	Set the secondary IPv4 DNS server.
Test	Click to test if the IP is conflicting.

Recipient

Protocol

URL

User



Password

Parameters	Description
Protocol	HTTP (post) or MQTT is optional.
HTTP	
URL	The device will post the people counting data in json format to this URL.
User	The username used for authentication.
Password	The password used for authentication.
MQTT	
Host	MQTT broker address to receive data.
Port	MQTT broker port to receive data.
Client ID	Client ID is the unique identity of the client to the server. It must be unique when all clients are connected to the same server, and it is the key to handle messages at QoS 1 and 2.
Username	The username used for connecting to the MQTT broker.
Password	The password used for connecting to the MQTT broker.
Topic	Topic name used for publishing.
QoS	QoS0, QoS1, QoS2 are optional.
TLS	Enable the TLS encryption in MQTT communication.
Certificate Type	CA Signed Server or Self Signed is optional. CA signed server certificate: verify with the certificate issued by Certificate Authority (CA) that pre-loaded on the device. Self signed certificates: upload the custom CA certificates, client certificates and secret key for verification.

5.4 Report

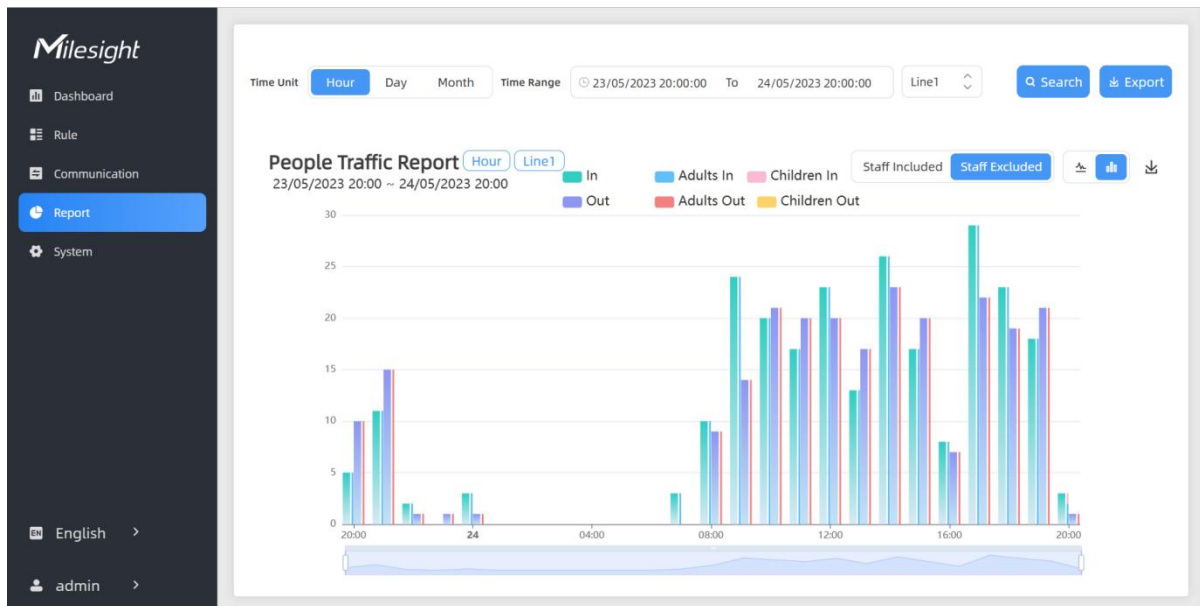
VS133 supports to generate visual line chart or bar chart to display the people traffic and supports to export the report. Before using this feature, **ensure that the device time is correct on System page.**



Parameters	Description
Time Unit	Select the unit to generate the graph or export the data.
Time Range	Select the time range to generate the graph.
Line1	Select the line to display the graph.
Search	Click to generate the graph according to the time range and line option.
Export	Export the historical traffic data as CSV file according to the selected time unit.
Staff Included/Excluded	Select whether to contain staff counting values on the graph.
	Select the display type as line or bar.
	Download the graph screenshot.

5.5 System

5.5.1 Device Info

All information about the hardware and software can be checked on this page. Besides, you can modify the device password and set the security questions here.

Device Info.

Device Name	People Counter <input type="text"/>
Product Model	VS133-915M
SN	6757D13928710005
Hardware Version	V1.0
Software Version	V_133.1.0.1-b-t14
MAC Address	24:E1:24:FF:00:04

Note: VS133-P supports to customize device ID and site ID for large amounts of devices management.

5.5.2 User

User

Users modify	<input type="button" value="Edit"/>
Security Question	<input type="button" value="Edit"/>

Parameters	Description								
Modify	<p>Click the admin on the user list, then you can click Modify to change the login password of this device.</p> <p>Users modify</p> <table border="1"> <tr> <td>Username</td> <td>admin</td> </tr> <tr> <td>Password</td> <td><input type="text"/></td> </tr> <tr> <td>New Password</td> <td><input type="text"/></td> </tr> <tr> <td>Confirm</td> <td><input type="text"/></td> </tr> </table> <p>At least:</p> <ul style="list-style-type: none"> • 8 characters • 2 types of characters: Number, letter and symbol 	Username	admin	Password	<input type="text"/>	New Password	<input type="text"/>	Confirm	<input type="text"/>
Username	admin								
Password	<input type="text"/>								
New Password	<input type="text"/>								
Confirm	<input type="text"/>								
Security Question	<p>Click to type administrator password, then set three security questions for your device. In case that you forget the password, you can click Forget Password button on login page to reset the password by answering three security</p>								

questions correctly.

Secure Question Settings Already Set

Password

Security Question1

What is your lucky number? ⌵

Answer1

Security Question2

What is your favorite sport? ⌵

Answer2

Security Question3

What is your favorite game? ⌵

Answer3

5.5.3 Time Configuration

Current System Time

Date 25/04/2023

Time 15:15:39

Set the System Time

Time Zone UTC+8:00 China Standard Time (CT/CST) ⌵

Synchronize Mode

NTP Timing

Manual Timing

Setting Time

25/04/2023 15:15:17

✕

✓

Synchronize with your computer time

Synchronize

Parameters	Description
Time Zone	Choose the time zone for your location.
Synchronize Mode (PoE Version)	NTP Timing or Manual Timing is optional.
Server Address (PoE Version)	NTP server address to sync the time.
Time Interval (PoE Version)	Set the interval to sync time with NTP server.

Setting Time	Set the device time manually.
Synchronize with computer time	Synchronize the time with your computer.

5.5.4 Remote Management (PoE Version)

Users can connect the device to the Milesight DeviceHub management platform on this page so as to manage the device centrally and remotely. For more details, please refer to [DeviceHub User Guide](#). **Before connecting, ensure the device has connected to network via Ethernet port and Internet connection is seamless.**

Remote Management

Status Disconnected

Server Address

Activation Method

Account Name

Password

[Connect](#)

Parameters	Description
Status	Show the connection status between the device and the DeviceHub.
Server Address	IP address or domain of the DeviceHub management server.
Activation Method	Select activation method to connect the device to the DeviceHub server, options are Authentication Code and Account .

5.5.5 System Maintenance

| Reset

Recovery device basic configuration

Basic Recovery

Recovery device to factory settings

All Recovery

| Reboot

Reboot the Device

Reboot

| Upgrade

Software Version

V_133.1.0.2-a1

Upgrade Image

Upgrade

Explanation:The upgrade process takes 1-10 minutes, do not turn off the power. The automatic reboot will happen once the upgrade complete.

| Backup and Restore

Export Config File

Export

Import Config File

Import

Parameters	Description
Reset	Recovery device basic configuration: keep the IP settings and user information when resetting.
	Recovery device to factory settings: reset device to factory default, which needs to verify admin password.
Reboot	Restart the device immediately.
Upgrade	Click the folder icon and select the upgrading file, then click the Upgrade button to upgrade. The update is done when the system reboots successfully. Note: The upgrade process takes about 1-10 minutes. Do not turn off the power and complete automatic restart after the upgrade.
Backup and Restore	Export Config File: Export configuration file.
	Import Config File: Click the file icon and select the configuration file, click Import button to import configuration file.

6. Installation Instruction

Parameter definition:

Parameters	Explanation	Value
H	Installation height	≤3.5 m
d	Minimum detection distance of VS133	0.5 m
Δd	Distance measurement error of VS133	0.035 m
h_{\max}	Maximum pedestrian height	Example 1.8 m
h_{\min}	Minimum pedestrian height	Example 1.7 m
α	ToF horizontal field of view angle	98°
β	ToF vertical field of view angle	80°
x	Length of detection range	
y	Width of detection range	

6.1 Installation Height

The maximum installation height is 3.5 m and the minimum installation height is $h_{\max}+d+\Delta d$. For example, when the maximum pedestrian height is 1.8 m, then the minimum installation height is $1.8+0.5+0.035=2.335$ m.

6.2 Covered Detection Area

The detection area covered by the device is related to the field of view angle of the device, the installation height and the target height. The length of the detection area is approximately $x=2.300 \times (H-h_{\min})$ and the width of the detection area is approximately $y=1.678 \times (H-h_{\min})$.

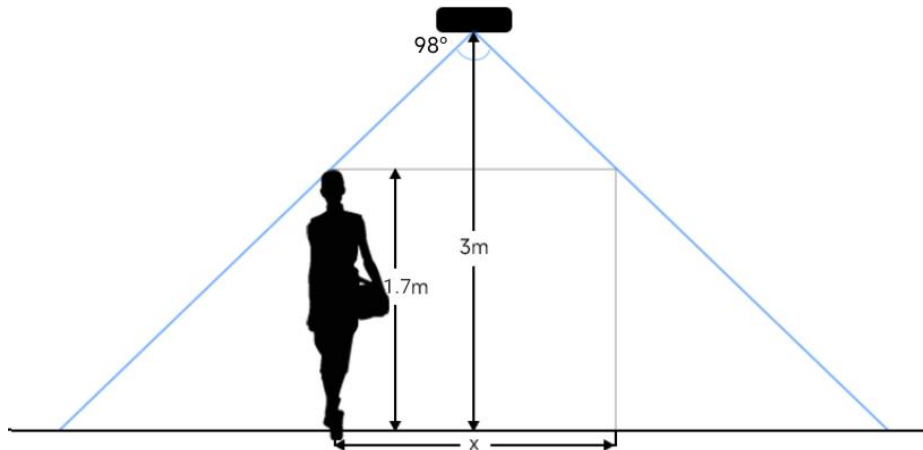

For example, if the Minimum height of pedestrians is 1.7 m, the detection area corresponding to each installation height is as follows:

Installation Height	FoV Monitored Area (m)	Detection Area (m)
2.5	5.75 × 4.20	1.84 × 1.34
2.6	5.98 × 4.36	2.07 × 1.51
2.7	6.21 × 4.53	2.30 × 1.68
2.8	6.44 × 4.70	2.53 × 1.85
2.9	6.67 × 4.87	2.76 × 2.01
3.0	6.90 × 5.03	2.99 × 2.18
3.1	7.13 × 5.20	3.22 × 2.35
3.2	7.36 × 5.37	3.45 × 2.52
3.3	7.59 × 5.54	3.68 × 2.69
3.4	7.82 × 5.71	3.91 × 2.85
3.5	8.05 × 5.87	4.14 × 3.02

6.3 Environment Requirements

- Black floor/carpet may affect the depth map and cause a lot of noises, but they will not affect the device to count people.

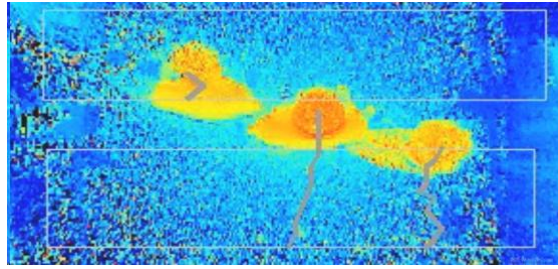

- Avoid 940nm light which may result in incorrect counting.
- Outdoor sunlight shining on the over channel will not have any effect, but the mirrored reflections that allow sunlight to shine on the ToF Sensor should be avoided.

6.4 Installation

Ceiling Mount

Step 1: Ensure the thickness of the ceiling is more than 30 mm, then attach the mounting sticker to the ceiling and drill 4 holes with a diameter of 6mm. If the wire needs to be extended to the interior of the ceiling, a wire hole with a suitable size is also required to be drilled.

Step 2: Fix the wall plugs into the ceiling holes.

Step 3: Remove the cover on the device, and then connect all required wires and pass them through the wire hole behind the device or block on the side of the device if the wires need to be protruded from the side of the device.

(**Note:** if the alarm I/O of VS133-P is going to be used, please connect a multi-interface cable to the device)

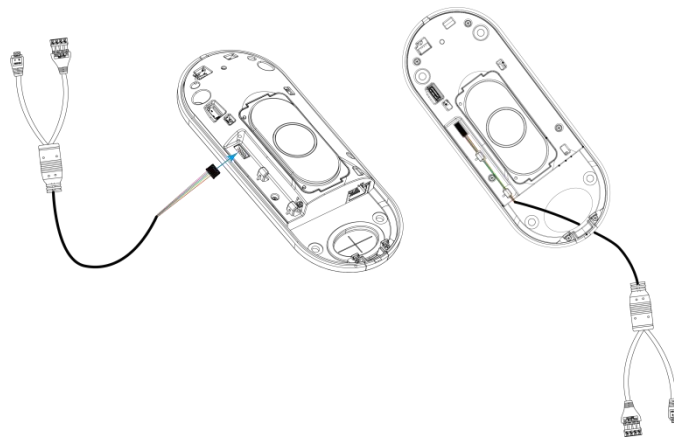

Step 4: Fix the device to the wall plugs via mounting screws; remember to adjust the mounting direction according to the detection area requirement.

Step 5: Fix the cover back to the device.

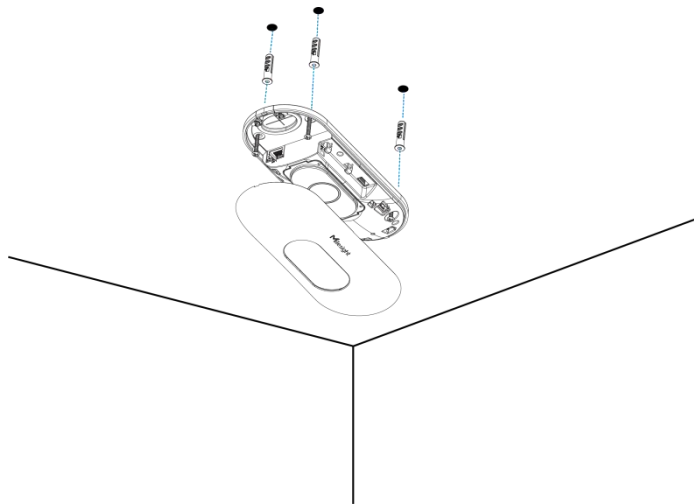

Ceiling/Lintel Mount (with Optional VB01 Multifunctional Bracket)

Step 1: Attach the mounting plate to the device with 4 screws.

Step 2: Fix the pole to the mounting plate with the hole on the plate.

Step 3: Adjust the length of the pole, then adjust the direction of 3-axis ball and tighten it with the handle.

Step 4: Determine the mounting location and drill 3 holes, fix the wall plugs into the mounting holes, then fix the bracket base to the wall plugs via mounting screws.

(Note: If the wire needs to be extended to the interior of the ceiling or wall, a wire hole with a suitable size is also required to be drilled.)

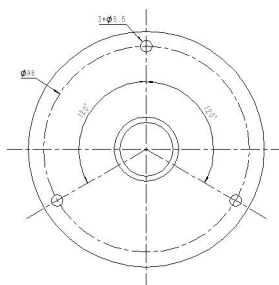

Step 5: Remove the cover on the device, and then connect all required wires and pass them through the inside of pole.

(Note: if the alarm I/O of VS133-P is going to be used, please connect a multi-interface cable to the device)

Step 6: Fix the pole to bracket base with screws and nuts.

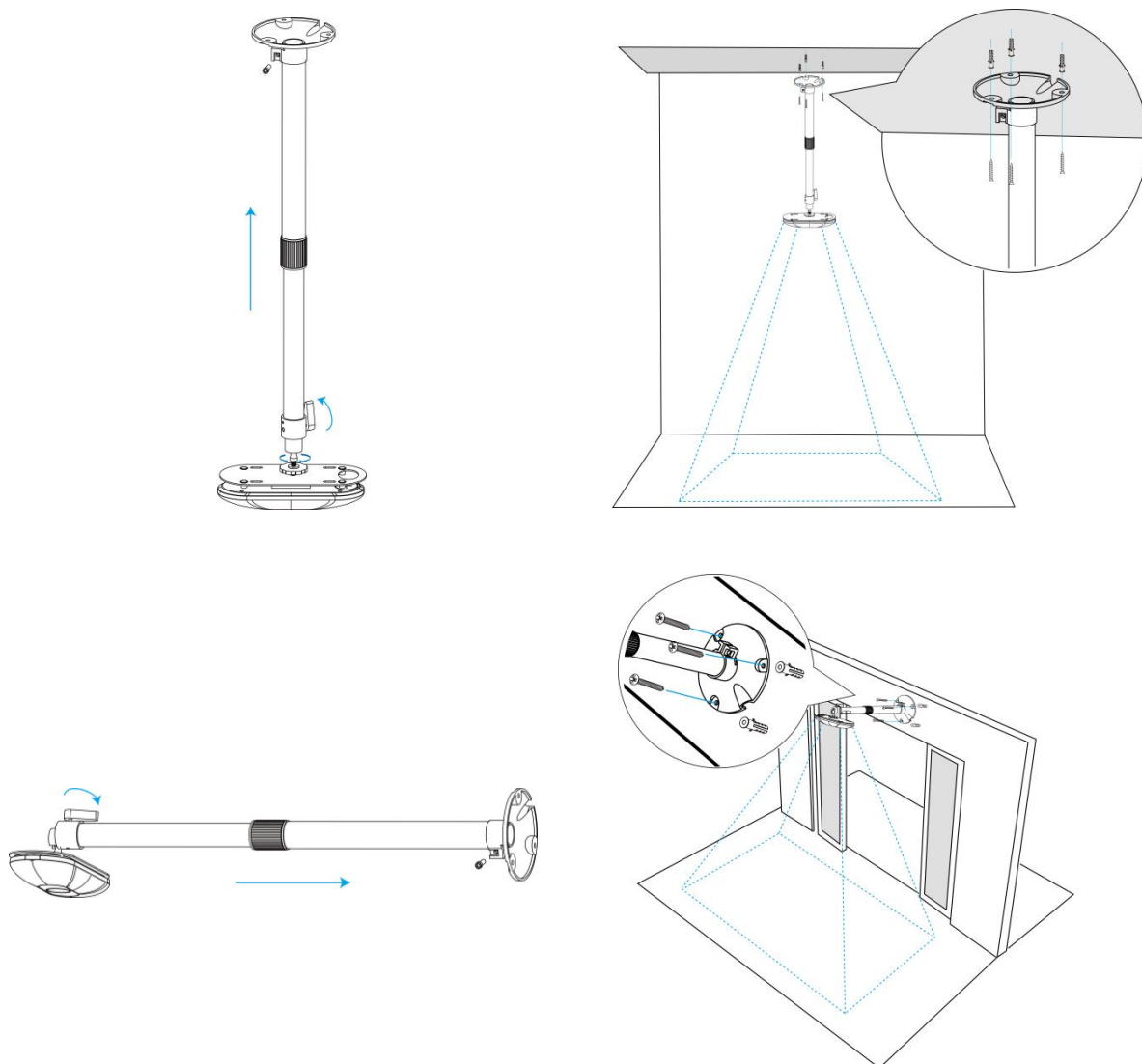
**Note:**

- Tilt installation should be avoided. Ensure that the front of the device and the ground plane are paralleled.
- Avoid installing the device against the wall and ensure that the device keeps away from the wall at least 30 cm on the short side and 50 cm on the long side.

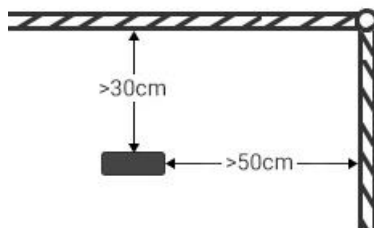

- Ensure that there are no other objects blocking the ToF light within a 30 cm radius of the front of the device.
- When you install devices on the top of swinging doors, it is suggested to keep the door normally open. If the door must be normally closed, please install the device on the other side of the door to keep away from the door movement. And it is suggested to keep away from the door with a distance of at least 30 cm.

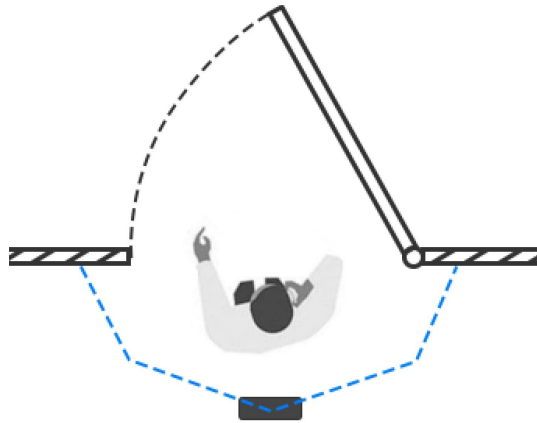

6.5 Factors Affecting Accuracy

- Wearing a fisherman's hat or carrying a cardboard box on the shoulder: The target will not be recognized because it will become unlike a human in depth map.
- Handheld or cart-carrying a humanoid doll with sufficient height to pass by: The doll will be mistakenly detected as people because it is human-like in depth map.

7. Communication Protocol

7.1 LoRaWAN® Version

Uplink Data

VS133 reports basic information of sensor whenever joining the network and the number of people periodically. For decoder examples please find files on <https://github.com/Milesight-IoT/SensorDecoders>.

Channel	Type	Description
ff	01 (Protocol Version)	01=> V1
	09 (Hardware Version)	01 04 => V1.4
	16 (Device SN)	16 digits
	1f (Software Version)	1f 07 00 4b => V31.7.0.75
03	d2 (Accumulated counter)	Line 1 accumulated in counter, 4 bytes
04	d2 (Accumulated counter)	Line 1 accumulated out counter, 4 bytes
05	cc (Periodic counter)	Line 1: Byte 1-2: in counter during the report interval Byte 3-4: out counter during the report interval
06	d2 (Accumulated counter)	Line 2 accumulated in counter, 4 bytes
07	d2 (Accumulated counter)	Line 2 accumulated out counter, 4 bytes

08	cc (Periodic counter)	Line 2: Byte 1-2: in counter during the report interval Byte 3-4: out counter during the report interval
09	d2 (Accumulated counter)	Line 3 accumulated in counter, 4 bytes
0a	d2 (Accumulated counter)	Line 3 accumulated out counter, 4 bytes
0b	cc (Periodic Counter)	Line 3: Byte 1-2: in counter during the report interval Byte 3-4: out counter during the report interval
0c	d2 (Accumulated counter)	Line 4 accumulated in counter, 4 bytes
0d	d2 (Accumulated counter)	Line 4 accumulated out counter, 4 bytes
0e	cc (Periodic Counter)	Line 4: Byte 1-2: in counter during the report interval Byte 3-4: out counter during the report interval

Note: If children distinction feature or staff detection feature is enabled, the counter uplinks will minus children and staff. For example, if children distinction is enabled, the accumulated in counter=total in counter-children in, the accumulated out counter=total out counter-children out.

Example:

1. Device information

ff0101 ff166600b09409760000 ff090102 ff1f85010001					
Channel	Type	Value	Channel	Type	Value
ff	01 (Protocol Version)	01 (V1)	ff	16(Device SN)	66 00 b0 94 09 76 00 00
Channel	Type	Value	Channel	Type	Value
ff	09 (Hardware version)	0102 (V1.2)	ff	1f (Software version)	85 01 00 01 (V133.1.0.1)

2. People counter

03d205000000 04d203000000 05cc02000100					
Channel	Type	Value	Channel	Type	Value
03	d2 (accumulated in counter)	05 00 00 00 => 00 00 00 05=5	04	d2 (accumulated out counter)	03 00 00 00 => 00 00 00 03=3
Channel	Type	Value			
05	cc (Periodic Counter)	In: 02 00 => 00 02 = 2 Out: 01 00 => 00			

		01 =1			
--	--	-------	--	--	--

Downlink Command

VS133 supports to configure the device via downlink commands. Application port is 85 by default.

Channel	Type	Description	
ff	10 (Reboot)	ff (Reserved)	
	03 (Reporting Interval)	2 Bytes, unit: s	
	04 (Confirm Mode)	00: disable, 01: enable	
	05 (LoRaWAN® Channel Mask)	Byte 1: Channel index range	
		01: 0-15	
		02: 16-31	
		03: 32-47	
		04: 48-63	
		05: 64-79	
	06: 80-95		
Byte 2-3: indicate disable or enable via every bit, 0=disable, 1=enable			
40 (ADR)	00: disable, 01: enable		
41 (Application Port)	1 Byte, default is 85		
42 (Wi-Fi)	00: disable, 01: enable		
43 (People Counting Periodic Report)	00: disable, 01: enable		
51 (Clear the accumulated counting)	ff (Reserved)		

Note: After changing any parameter of LoRaWAN® settings, the device will re-join the network.

Example:

1. Disable Wi-Fi.

ff4200		
Channel	Type	Value
ff	42 (Wi-Fi)	00: disable

2. Set AU915 or US915 channel mask as 8-15.

ff0501ff00 ff05020000 ff05030000 ff05040000 ff05050000		
Channel	Type	Value

ff	05 (Set Channel Mask)	01: Channel index 0-15, ff00 => 8-15 is enabled 02-05: Channel index 16-79, 0000 => all disabled
----	--------------------------	---

3. Reboot the device.

ff10ff		
Channel	Type	Value
ff	10 (Reboot)	ff (Reserved)

4. Set reporting interval as 20 minutes.

ff03b004		
Channel	Type	Value
ff	03(Set Reporting Interval)	b0 04 => 04 b0 = 1200s =20 minutes

7.2 PoE Version

VS133-P will post the people counting data in json format to HTTP URL or MQTT broker.

● Periodic Report

```
{
  "event": "People Counting",
  "report_type": "period",
  "device_info": {
    "device_name": "People Counter",
    "device_sn": "369362028335",
    "device_mac": "00:16:28:FA:8E:68",
    "ip_address": "192.168.0.99"
    "cus_device_id": "123468773",           //Customized device ID
    "cus_site_id": "asdfasf1231231"       //Customized site ID
    "running_time": 1564648484648         //unit: s
  },
  "time_info": {
    "start_time": "2022-12-20T18:15:52+03:00", //Period start time
    "end_time": "2022-12-20T19:15:52+03:00"  //Period end time
  },
  "period_data": [
    {
      "line": 1,
      "in": 10,
      "out": 10,
      "staff_in": 1,
      "staff_out": 1,
      "children_in": 1,
      "children_out": 1
    }
  ]
}
```



```

        "line":2,
        "in":10,
        "out":10,
        "staff_in":1,
        "staff_out":1,
        "children_in":1,
        "children_out":1
    }
}
"total_data":[
    {
        "line":1,
        "in_counted":10,        //accumulated in counter
        "out_counted":10,        //accumulated out counter
        "capacity_counted":0,    //in_counted-out_counted
        "staff_in_counted":1,
        "staff_out_counted":1,
        "children_in_counted":1,
        "children_out_counted":1
    }
    {
        "line":2,
        "in_counted":10,
        "out_counted":10,
        "capacity_counted":0,
        "staff_in_counted":1,
        "staff_out_counted":1,
        "children_in_counted":1,
        "children_out_counted":1
    }
}
}
}

```

● Trigger Report

```

{
    "event":"People Counting",
    "time":"2022-12-20T18:15:52+03:00",
    "report_type": "trigger",
    "device_info":{
        "device_name":"People Counter",
        "device_sn":"369362028335",
        "device_mac":"00:16:28:FA:8E:68",
        "ip_address":"192.168.0.99"
    }
    "cus_device_id":"123468773",        //Customized device ID
    "cus_site_id":"asdfasf1231231"    //Customized site ID
    "running_time": 1564648484648      //Unit: s
},

```

```
"trigger_data":[  
  {  
    "line":1,  
    "in":1,           //One person in  
    "out":0,  
    "staff_in":1,    //The person is staff  
    "staff_out":0,  
    "children_in":0,  
    "children_out":0  
  },  
  {  
    "line":2,  
    "in":1,  
    "out":0,  
    "staff_in":1,  
    "staff_out":0,  
    "children_in":0,  
    "children_out":0  
  }  
]  
}
```

-END-