

**JUMO GmbH & Co. KG**

Delivery address: Mackenrodtstraße 14,  
36039 Fulda, Germany  
Postal address: 36035 Fulda, Germany  
Phone: +49 661 6003-0  
Fax: +49 661 6003-607  
E-mail: mail@jumo.net  
Internet: www.jumo.net

**JUMO Instrument Co. Ltd.**

JUMO House  
Temple Bank, Riverway  
Harlow - Essex CM20 2DY, UK  
Phone: +44 1279 63 55 33  
Fax: +44 1279 63 52 62  
E-mail: sales@jumo.co.uk  
Internet: www.jumo.co.uk

**JUMO Process Control, Inc.**

8 Technology Boulevard  
Canastota, NY 13032, USA  
Phone: 315-697-JUMO  
1-800-554-JUMO  
Fax: 315-697-5867  
E-mail: info@jumo.us  
Internet: www.jumo.us



# JUMO MAERA S28

## Level Probe

### Applications

#### Level and liquid level measurement in<sup>1</sup>

- water and wastewater management
- well water and surface water
- bore holes

### Brief description

level probes are used for hydrostatic liquid level measurement in tanks or for determining the level in open waters, for example.

The level probe can detect levels from 0 to 2.5 mWC to 0 to 100 mWC (water column). The sturdy design and choice of materials allow the probe to be mounted indoors or outdoors. Based on outside assembly, overvoltage protection is integrated in the level probe to protect it against destruction in the event of lightning striking the surrounding water.

When determining the level, it is necessary to consider that each liquid has a temperature-dependent density. Consequently, the density value at a liquid temperature of 5 °C is not the same as that at 30 °C. These data are presented in a system of tables. A version with an integrated Pt100 temperature sensor is available as an option, to allow the temperature profile of the liquid to be recorded in parallel during measurement.

For additional, interesting information, see the "level probes - hydrostatic level and liquid level measurement" brochure.

### Customer benefits

- **Process safety** The output signal emits a minimum current of 4 mA, which can indirectly and easily monitor the circuit for a break in the cable. Integrated overvoltage protection prevents the level probe being destroyed by a lightning strike, and thus ensures maximum process safety. The crucial element is a piezoresistive measuring cell, which has high overload resistance and long-term stability.
- **Diversity and economy** A vast selection of measuring ranges and electrical outputs, as well as numerous process connections, ensure great variety, which can be individually adapted to suit every application. Simultaneous measurement of liquid level and temperature can be implemented with a Pt100 temperature sensor option. Costs are reduced to a minimum by reduced installation and commissioning expenditure.



Type 404392/...  
with process connection 658

### Key features

- Measuring ranges from 0 to 250 mbar to 0 to 10 bar
- Temperature of measuring material 0 to 50 °C
- Piezoresistive silicon sensor
- Extremely good long-term stability
- High overload resistance
- Integrated overvoltage protection
- Indirect cable-break monitoring
- Sturdy level probe for indoor and outdoor assembly
- Integrated Pt100 temperature sensor option

<sup>1</sup> These recommendations are based on many years of experience. Deviations are possible in some cases. We would be happy to provide you with additional information or details of other applications.

**JUMO GmbH & Co. KG**

Delivery address: Mackenrodtstraße 14,  
36039 Fulda, Germany  
Postal address: 36035 Fulda, Germany  
Phone: +49 661 6003-0  
Fax: +49 661 6003-607  
E-mail: mail@jumo.net  
Internet: www.jumo.net

**JUMO Instrument Co. Ltd.**

JUMO House  
Temple Bank, Riverway  
Harlow - Essex CM20 2DY, UK  
Phone: +44 1279 63 55 33  
Fax: +44 1279 63 52 62  
E-mail: sales@jumo.co.uk  
Internet: www.jumo.co.uk

**JUMO Process Control, Inc.**

8 Technology Boulevard  
Canastota, NY 13032, USA  
Phone: 315-697-JUMO  
1-800-554-JUMO  
Fax: 315-697-5867  
E-mail: info@jumo.us  
Internet: www.jumo.us



## Technical data

### General

Reference conditions	DIN 16086 and EN 60770
Principle of measurement	Piezoresistive sensor with stainless steel separating diaphragm
Pressure transfer medium	Synthetic oil
Permissible load change	> 10 million, 0 to 100 % measuring range
Mounting location	Vertical/suspended on the cable

### Measuring range

Relative pressure	The measuring ranges start at 0 bar.									
Measuring range	0.25	0.4	0.6	1	1.6	2.5	4	6	10	bar
Overload capacity	0.75	1.2	1.8	3	4.8	7.5	12	18	30	bar
Bursting pressure	1	1.6	2.4	4	6.4	10	16	24	40	bar

### Output

Analog output <sup>a</sup>	
Current	
Output 405	4 to 20 mA, two wires
Jump response	
T <sub>90</sub>	≤ 10 ms
Burden	
Current	
4 to 20 mA, two wires	$R_L \leq (U_B - 10 \text{ V}) / 0.02 \text{ A} (\Omega)$

<sup>a</sup> Other outputs are available on request.

### Mechanical properties

Process connection	
Material	316 Ti stainless steel
Measurement diaphragm	
Material	316L stainless steel
Housing	
Material	316 Ti stainless steel
Sealings	
Material	FPM
Weight	400 g (without cable)
Diameter	25 mm

**JUMO GmbH & Co. KG**  
 Delivery address: Mackenrodtstraße 14,  
 36039 Fulda, Germany  
 Postal address: 36035 Fulda, Germany  
 Phone: +49 661 6003-0  
 Fax: +49 661 6003-607  
 E-mail: mail@jumo.net  
 Internet: www.jumo.net

**JUMO Instrument Co. Ltd.**  
 JUMO House  
 Temple Bank, Riverway  
 Harlow - Essex CM20 2DY, UK  
 Phone: +44 1279 63 55 33  
 Fax: +44 1279 63 52 62  
 E-mail: sales@jumo.co.uk  
 Internet: www.jumo.co.uk

**JUMO Process Control, Inc.**  
 8 Technology Boulevard  
 Canastota, NY 13032, USA  
 Phone: 315-697-JUMO  
 1-800-554-JUMO  
 Fax: 315-697-5867  
 E-mail: info@jumo.us  
 Internet: www.jumo.us



## Ambient conditions

Permissible temperatures Medium/environment	0 to 50 °C The instrument must <b>not</b> be allowed to freeze in the medium!The medium may make it necessary to impose a restriction.
Storage	-20 to +80 °C, dry
Electromagnetic compatibility Interference emission <sup>a</sup> Interference immunity <sup>b</sup>	Class B Industrial requirements
Overvoltage protection <sup>c</sup>	Integrated overvoltage protection nominal discharge current: 1 kA
Protection <sup>d</sup>	IP68, immersible to 400 m

<sup>a</sup> As defined by EN 61326-2-3

<sup>b</sup> As defined by EN 61326-1

<sup>c</sup> As defined by EN 61000-4-5

<sup>d</sup> As defined by EN 60529

## Accuracy

Relative pressure	The measuring ranges start at 0 bar.									
Measuring range	0.25	0.4	0.6	1	1.6	2.5	4	6	10	bar
Linearity <sup>a</sup>	<b>0.3</b>	<b>0.3</b>	<b>0.3</b>	<b>0.3</b>	<b>0.3</b>	<b>0.3</b>	<b>0.2</b>	<b>0.2</b>	<b>0.2</b>	<b>% of FS</b>
Accuracy at 20 °C <sup>b</sup>	0.5	0.5	0.5	0.5	0.5	0.5	0.3	0.3	0.3	% of FS
Accuracy at 0 to 50 °C <sup>c</sup>	1.6	1.6	1.3	1.1	1.1	1.1	0.8	0.8	0.8	% of FS
Long-term stability <sup>d</sup>	≤ 0.2 % of FS									

<sup>a</sup> Linearity based on limit point setting

<sup>b</sup> Includes: linearity, hysteresis, repeatability, deviation from initial (offset) and final values of measuring range

<sup>c</sup> Includes: linearity, hysteresis, repeatability, deviation from initial (offset) and final values of measuring range, thermal effect on initial value of measuring range and span

<sup>d</sup> As defined by EN 61298-1

## Auxiliary power

Supply voltage U <sub>B</sub> <sup>a</sup>	DC 10 to 30 V, nominal voltage DC 24 V
Max. power consumption	≤ 30 mA
Circuit	SELV

<sup>a</sup> Residual ripple: Peak voltages must not exceed or fall below the values specified for the power supply!

**JUMO GmbH & Co. KG**

Delivery address: Mackenrodtstraße 14,  
36039 Fulda, Germany  
Postal address: 36035 Fulda, Germany  
Phone: +49 661 6003-0  
Fax: +49 661 6003-607  
E-mail: mail@jumo.net  
Internet: www.jumo.net

**JUMO Instrument Co. Ltd.**

JUMO House  
Temple Bank, Riverway  
Harlow - Essex CM20 2DY, UK  
Phone: +44 1279 63 55 33  
Fax: +44 1279 63 52 62  
E-mail: sales@jumo.co.uk  
Internet: www.jumo.co.uk

**JUMO Process Control, Inc.**

8 Technology Boulevard  
Canastota, NY 13032, USA  
Phone: 315-697-JUMO  
1-800-554-JUMO  
Fax: 315-697-5867  
E-mail: info@jumo.us  
Internet: www.jumo.us



## Electrical connection

6-core, shielded cable with integrated pressure compensation tube; AWG 24 with ferrules

Material	
Outer sheath	PE, PUR, FEP
Pressure compensation tube	PA
Color	
PE and FEP cables	Black
PUR cable	Pebble-gray
External diameter	Approx. 8.4 mm
Conductor cross-section	0.25 mm <sup>2</sup>
Bending radius	
moveable	160 mm
fixed	120 mm
	Please note that a bend in the cable prevents ambient pressure compensation.
Tensile force	Up to 400 N
Weight	
PE and PUR cables	Approx. 115 g/m
FEP cable	Approx. 90 g/m
Permissible medium temperatures	-40 to +70 °C (subject to the medium)
UV resistance	PE and PUR cables as defined by VDE 0207, test method EN 60811 part 2-1, section 8 FEP cables as defined by EN ISO 4892-2

**JUMO GmbH & Co. KG**

Delivery address: Mackenrodtstraße 14,  
36039 Fulda, Germany  
Postal address: 36035 Fulda, Germany  
Phone: +49 661 6003-0  
Fax: +49 661 6003-607  
E-mail: mail@jumo.net  
Internet: www.jumo.net

**JUMO Instrument Co. Ltd.**

JUMO House  
Temple Bank, Riverway  
Harlow - Essex CM20 2DY, UK  
Phone: +44 1279 63 55 33  
Fax: +44 1279 63 52 62  
E-mail: sales@jumo.co.uk  
Internet: www.jumo.co.uk

**JUMO Process Control, Inc.**

8 Technology Boulevard  
Canastota, NY 13032, USA  
Phone: 315-697-JUMO  
1-800-554-JUMO  
Fax: 315-697-5867  
E-mail: info@jumo.us  
Internet: www.jumo.us

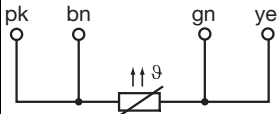

## Connection diagram

Connection		Pin assignment
		
<b>Output 405 (4 to 20 mA, two wires)</b>		Cable
Supply voltage DC 10 to 30 V	$U_{B/S}^{+a}$ 0 V/S-	White Gray
<b>Screen</b>		
Caution: Ground the instrument! Ground all connected devices (e.g. pumps, valves) to the same potential!		Black
<b>Integrated temperature sensor (basic type extension 007)</b>		
		Pink (pk) Brown (bn) Green (gn) Yellow (ye)

<sup>a</sup> The voltage spikes may not exceed or fall below the specified values of the voltage supply!

**JUMO GmbH & Co. KG**  
 Delivery address: Mackenrodtstraße 14,  
 36039 Fulda, Germany  
 Postal address: 36035 Fulda, Germany  
 Phone: +49 661 6003-0  
 Fax: +49 661 6003-607  
 E-mail: mail@jumo.net  
 Internet: www.jumo.net

**JUMO Instrument Co. Ltd.**  
 JUMO House  
 Temple Bank, Riverway  
 Harlow - Essex CM20 2DY, UK  
 Phone: +44 1279 63 55 33  
 Fax: +44 1279 63 52 62  
 E-mail: sales@jumo.co.uk  
 Internet: www.jumo.co.uk

**JUMO Process Control, Inc.**  
 8 Technology Boulevard  
 Canastota, NY 13032, USA  
 Phone: 315-697-JUMO  
 1-800-554-JUMO  
 Fax: 315-697-5867  
 E-mail: info@jumo.us  
 Internet: www.jumo.us



## Dimensions

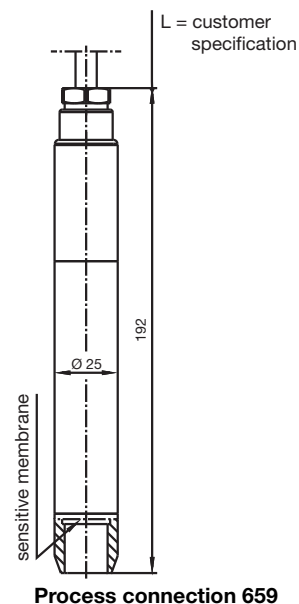
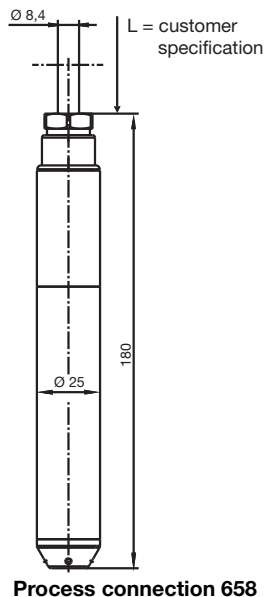
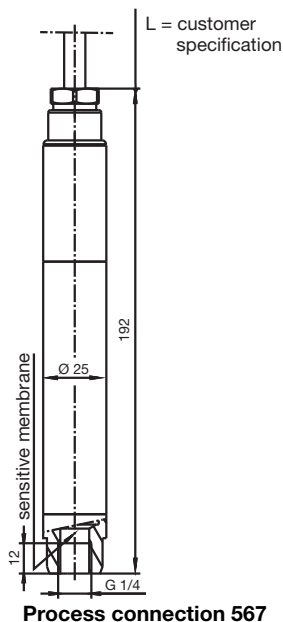

## Dimensions of accessories

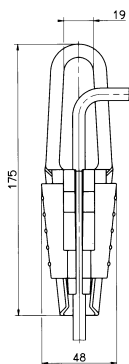

**Cable clamp assembly**  
 Part no.: 00061389

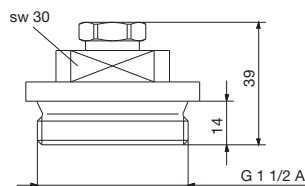

**Screw plug (cover mounting)**  
 Part no.: 00333329

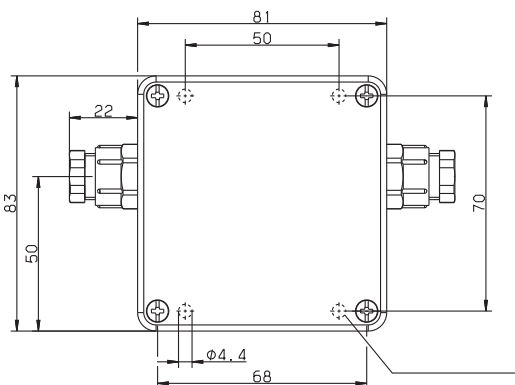
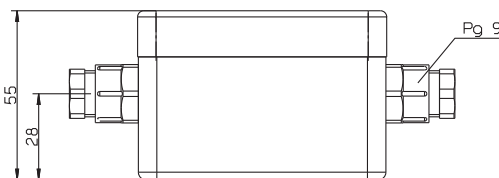

**Terminal box with pressure compensation**  
 Part no.: 00061206

**JUMO GmbH & Co. KG**

Delivery address: Mackenrodtstraße 14,  
36039 Fulda, Germany  
Postal address: 36035 Fulda, Germany  
Phone: +49 661 6003-0  
Fax: +49 661 6003-607  
E-mail: mail@jumo.net  
Internet: www.jumo.net

**JUMO Instrument Co. Ltd.**

JUMO House  
Temple Bank, Riverway  
Harlow - Essex CM20 2DY, UK  
Phone: +44 1279 63 55 33  
Fax: +44 1279 63 52 62  
E-mail: sales@jumo.co.uk  
Internet: www.jumo.co.uk

**JUMO Process Control, Inc.**

8 Technology Boulevard  
Canastota, NY 13032, USA  
Phone: 315-697-JUMO  
1-800-554-JUMO  
Fax: 315-697-5867  
E-mail: info@jumo.us  
Internet: www.jumo.us



## Order details

<b>(1) Basic type</b>	
404392/000	JUMO MAERA S28 - Level probe
404392/025	JUMO MAERA S28 - Level probe, deep well version <sup>a</sup>
404392/999	JUMO MAERA S28 - Level probe, special version
<b>(2) Input</b>	
451	0 to 250 mbar relative pressure
452	0 to 400 mbar relative pressure
453	0 to 600 mbar relative pressure
454	0 to 1 bar relative pressure
455	0 to 1.6 bar relative pressure
456	0 to 2.5 bar relative pressure
457	0 to 4 bar relative pressure
458	0 to 6 bar relative pressure
459	0 to 10 bar relative pressure
999	Special measuring range relative pressure
<b>(3) Output</b>	
405	4 to 20 mA, 2-wire
<b>(4) Process connection</b>	
567	Internal G 1/4
658	Connection closed at bottom
659	Connection open at bottom
<b>(5) Material of process connection</b>	
20	CrNi (stainless steel)
<b>(6) Electrical connection</b>	
14	PUR cable, grey, screened, e.g. suitable for use in water (seawater, well water, pit water), as well as in coolant and lubricant (UV-resistant)
15	PE-LD cable, black, screened, e.g. suitable for use in water (seawater, well water, pit water, UV-resistant)
25	FEB cable, black, screened, e.g. suitable for use in water (seawater, saltwater, well water, and mine water) as well as in different oils, fuels, and solvents (UV-resistant)
26	Submersible motor line, EPR cable, blue, e.g. suitable for use in water (drinking water)
99	Special version
<b>(7) Cable length</b>	
005	5 m
010	10 m
...	...
100	100 m
999	Special lengths on request
<b>(8) Extra code</b>	
000	None
007	Integrated Pt100 temperature sensor
593	Cutting ring screw connection (preparation for protection tube)
631	Higher humidity and vibration protect

<sup>a</sup> The deep-well version was designed for use in measuring ranges between 0 to 4 bar to 0 to 10 bar with a free-hanging cable length of up to 100 m. Area of application: the version is only available with a closed process connection and an EPR-cable without pressure compensation. Another benefit is the improved moisture and vibration protection. The user must always bear in mind that a stainless-steel version is not suitable for use in media containing chlorine (such as seawater).

**JUMO GmbH & Co. KG**

Delivery address: Mackenrodtstraße 14,  
36039 Fulda, Germany  
Postal address: 36035 Fulda, Germany  
Phone: +49 661 6003-0  
Fax: +49 661 6003-607  
E-mail: mail@jumo.net  
Internet: www.jumo.net

**JUMO Instrument Co. Ltd.**

JUMO House  
Temple Bank, Riverway  
Harlow - Essex CM20 2DY, UK  
Phone: +44 1279 63 55 33  
Fax: +44 1279 63 52 62  
E-mail: sales@jumo.co.uk  
Internet: www.jumo.co.uk

**JUMO Process Control, Inc.**

8 Technology Boulevard  
Canastota, NY 13032, USA  
Phone: 315-697-JUMO  
1-800-554-JUMO  
Fax: 315-697-5867  
E-mail: info@jumo.us  
Internet: www.jumo.us



Order code            (1)            (2)            (3)            (4)            (5)            (6)            (7)            (8)  
 Order example        404392/000 - 454 - 405 - 659 - 20 - 15 - 020 / 007, 631

## Accessories

Article	Part no.
Terminal box with pressure compensation	00061206
Cable clamp assembly <sup>a</sup>	00061389
Screw plug	00333329
Pressure compensating filter for cable	00382632

<sup>a</sup> The hot-dip galvanized housing is made of sheet steel. The clamping jaws and guide chambers are made of fiberglass-reinforced PA molding compound.