



## Features

- 10 pressure ranges in same unit selectable via DIP-switches on pcb.
- Full range:  
0 to 100 Pa, 0 to 250 Pa, 0 to 500 Pa, 0 to 750 Pa or 0 to 1000 Pa
- Bidirectional:  
-50 to +50 Pa , -125 to 125 Pa, -250 to +250 Pa  
-375 to +375 Pa or -500 to +500 Pa
- Other pressure units than Pa are available and selectable via DIP switches on pcb  
mmHH2O, mbar, inWG, mmHG, daPa, Kpa, hPa
- High accuracy +/-1%
- Power Supply and Output  
16-30 Vac/dc with 0-10 Vdc (3-wire) for PAT 010D  
12-30 Vdc with 4-20 mA (2-wire) for PAT 420D
- LCD digital display  
LCD size 50 x 22.5 mm  
Digital height, Value 10 mm, Units 5 mm
- Response time selectable via DIP switches on pcb  
0.5 ,1.0, 2.0 or 4.0 seconds
- Including duct fixing kit
- Including mounting bracket
- IP54 protection
- Size 104 x 90 x 44 mm
- Power consumption <1.5W
- Tolerated Overpressure 15 Kpa
- Operating Temperature -10 to +60°C
- Storage Temperature -10 to +70°C
- Pressure connection ribbed dia. 6.2 mm
- Cable gland PG9 for cables dia. 8 mm max.







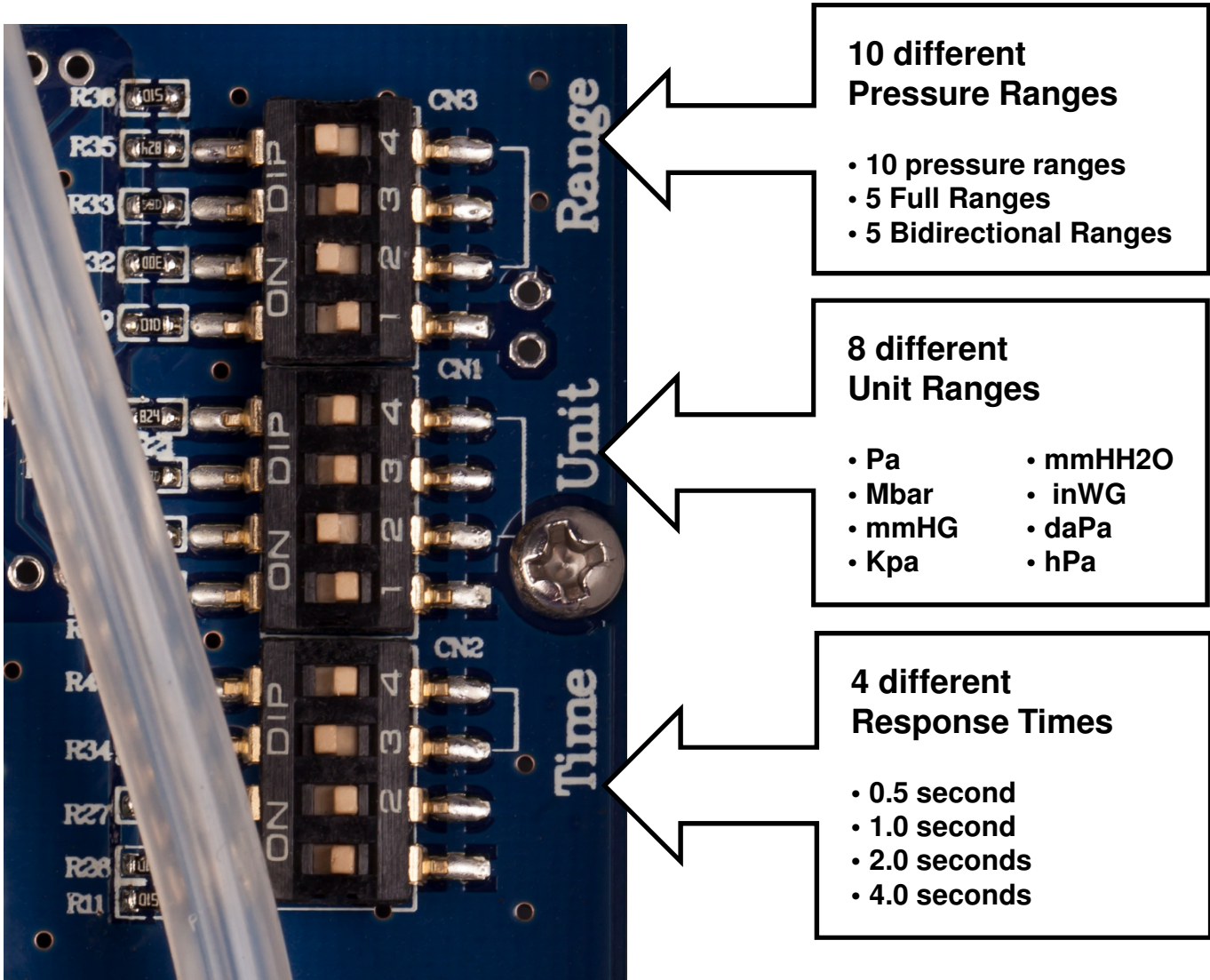









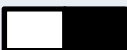

## Ordering

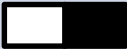
Type no.	Description
PAT 010D	Air differential pressure transmitter Multi pressure ranges selectable Multi pressure units selectable <b>0-10 Vdc output</b>
PAT 420D	Air differential pressure transmitter Multi pressure ranges selectable Multi pressure units selectable <b>4-20 mA output</b>

DIP-switches on PCB to select Pressure Range, Pressure Unit and Response Time

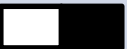

Setting the pressure range (full range) via DIP-switches on pcb





















Setting	Pa	mmh2O	mbar	inWG	mmHG	daPa	Kpa	hPa
 4  3  2  1	0/100	0/10.0	0/1.00	0/0.40	0/0.75	0/10.0	0/0.100	0/1.00
 4  3  2  1	0/250	0/25.0	0/2.50	0/1.00	0/1.87	0/25.0	0/0.250	0/2.50
 4  3  2  1	0/500	0/50.0	0/5.00	0/2.00	0/3.750	0/50.0	0/0.500	0/5.00
 4  3  2  1	0/750	0/75.0	0/7.50	0/3.00	0/5.62	0/75.0	0/0.750	0/7.50
 4  3  2  1	0/1000	0/100.0	0/10.0	0/4.00	0/7.50	0/100.0	0/1.000	0/10.00

Above setting is for **full ranges** for example 0 to 1000 Pa.

For **bidirectional ranges** for example -500 to +500 Pa, see setting on next page

The PAT device need to be powered off and powered on after changed the pressure range DIP-switches

Setting the pressure range (bidirectional range) via DIP-switches on pcb

Setting	Pa	mmh2O	mbar	inWG	mmHG	daPa	Kpa	hPa
 4								
 3	-50/ +50	-5.0/ +5.0	-0.50/ +0.50	-0.20/ +0.20	-0.375/ +0.375	-5.0/ +5.0	-0.50/ +0.50	-0.50/ +0.50
 2								
 1								
 4								
 3	-125/ +125	-12.5/ +12.5	-1.25/ +1.25	-0.50/ +0.50	-0.935/ +0.935	-12.5/ +12.5	-0.125/ +0.125	-1.25/ +1.25
 2								
 1								
 4								
 3	-250/ +250	-25.0/ +25.0	-2.50/ +2.50	1.00/ +1.00	-1.875/ +1.875	-25.0/ +25.0	-0.250/ +0.250	-2.50/ +2.50
 2								
 1								
 4								
 3	-375/ +375	-37.5/ +37.5	-3.75/ +3.75	-1.50/ +1.50	-2.81/ +2.81	-37.5/ +37.5	-0.375/ +0.375	-3.75/ +3.75
 2								
 1								
 4								
 3	-500/ +500	-50.0/ +50.0	-5.0/ +5.0	-2.00/ +2.00	-3.75/ +3.75	-50.0/ +50.0	-0.5/ +0.5	-5.00/ +5.00
 2								
 1								

Above setting is for **bidirectional ranges** for example -500 Pa to 500 Pa.

For **Full Ranges** for example 0 to +1000 Pa, see setting on previous page.

The PAT device need to be powered off and powered on after changed the pressure range DIP-switches.

Setting the pressure unit via DIP-switches on pcb

Pa	mmh2O	mbar	inWG
4	4	4	4
3	3	3	3
2	2	2	2
1	1	1	1

mmHG	daPa	Kpa	hPa
4	4	4	4
3	3	3	3
2	2	2	2
1	1	1	1

The PAT device need to be powered off and powered on after changed the pressure unit DIP-switches.

Setting the response time via DIP-switches on pcb

0.5 second	1 second	2 seconds	4 seconds
4	4	4	4
3	3	3	3
2	2	2	2
1	1	1	1

The PAT device need to be powered off and powered on after changed the response time DIP-switches

## Mounting and Electrical Measurement

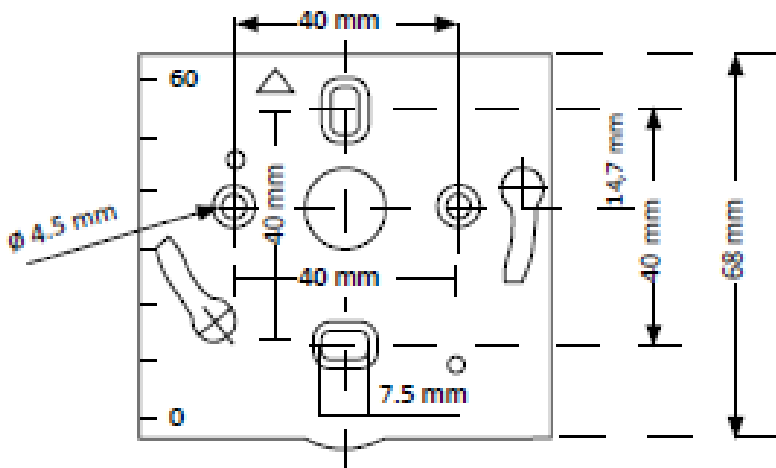

### Mounting

To mount the PAT air differential pressure transmitter, mount the ABS plate on the wall. Insert the PAT air differential pressure transmitter on the fixing plate.

Rotate the housing in clockwise direction until you hear a 'click' which confirms that the PAT air differential pressure transmitter is correctly installed.

### Electrical Measurement

Electrical measurement ( + - OUT ) on pcb terminals can be done by removing the grey rubber plug on the back side of the PAT device.

**Dimensions**

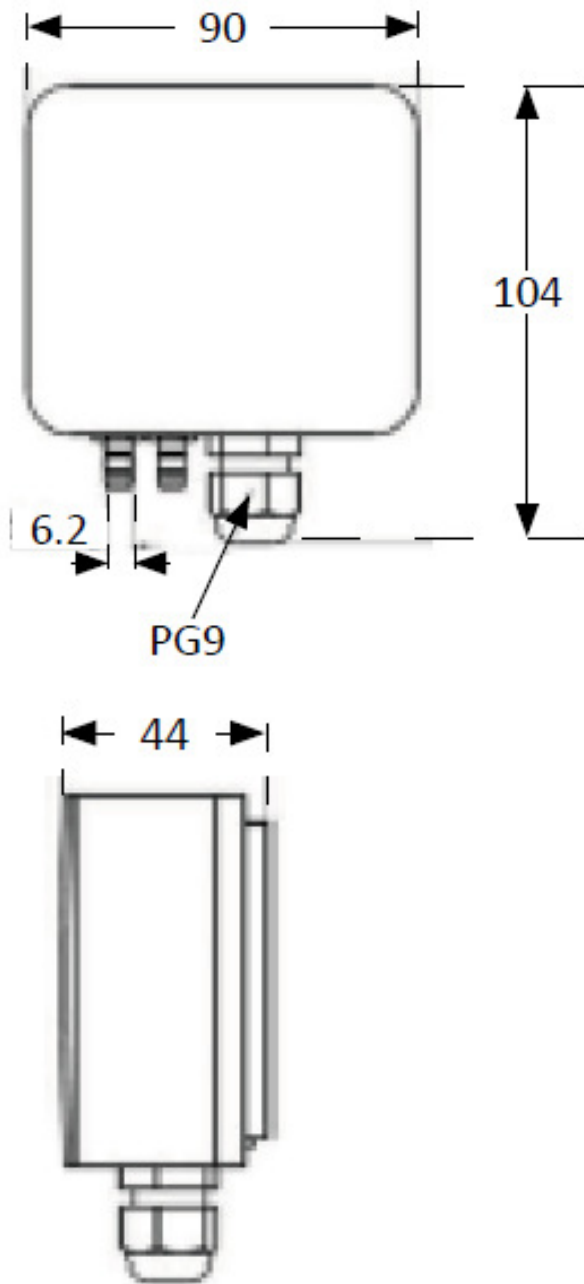

**Electrical connection**

PAT 010D with  
0-10 Vdc output 3-wire

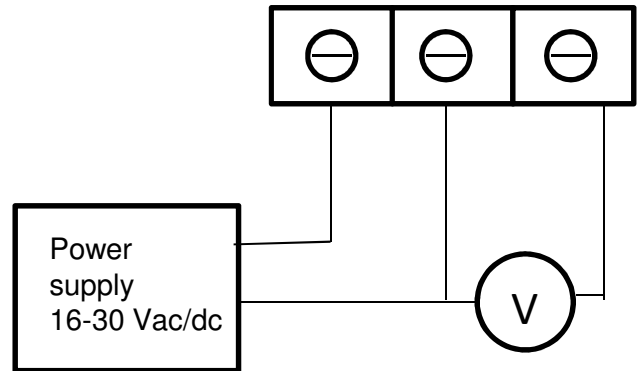

PAT 420D with  
4-20 mA output 2-wire  
non-polarized  
12-30 Vdc

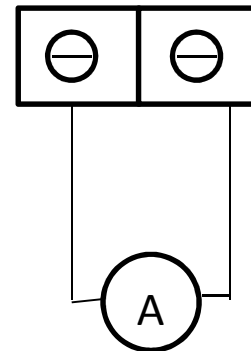

## Maintenance

Please avoid any aggressive solvent and protect the PAT air differential pressure transmitter and its probes from any cleaning product containing formalin, that may be used for cleaning rooms and ducts.

## Note

The Setting button and Auto Zero button on PCB only to be used by the factory

## Common problem and solutions

1. The display range or units do not tally with the Settings.
  - a) The DIP-switch is not in place, the electricity to restart the redial later.
  
2. Pressure showed no change or the output value (display of 0 or FULL), or change is not allowed.
  - a) whether the load pressure over blasting pressure directly blunt bad core body;
  - b) whether there is corrosive or use media. And the purchased product applicable medium exist discrepancy (existing micro differential pressure transmitter are for no corrosive gas);
  - c) check whether there is any foreign bodies blocked on inlet hose (particulate matter or water) or leakage;
  - d) using the environment temperature is beyond compensation temperature range (micro differential pressure transmitter temperature compensation range - 10 to 60 C);
  - e) with and without the pressure to zero wrong operation, such as there is no input in determining the state of stress under the reset again;
  - f) have corrosive Settings button of wrong operation (Settings button to prevent wrong operation mechanism, namely the set point pressure value must be increasing from small to big to finally set up successful, needs to be in high precision pressure source under the calibration set, don't recommend customer to calibration, such as the deviation caused by the calibration operation, must be returned to the factory).
  
3. Pressure normal value, no output analog or analog output is not allowed.
  - a) check the output line connection is normal;
  - b) three wire system output is to detect transducer with control instrument is normal (i.e., ground wire must be connected to);
  - c) check the load resistance to choose proper.
  
4. The zero pressure value drift slightly.
  - a) clear operation after drift stability. If the above method cannot eliminate the fault, contact the manufacturer!