

Model 21 Process pH Sensor

Features

- Patented Plunger¹ pH Electrode
- Choice of High Temperature, High pH or ORP Measurement
- Patented Porous² Teflon[®] Liquid Junctions
- Double Junction Reference Cell
- **New** Cast-In-Place Solid Reference Electrolyte
- Optional Integral Unity Gain Preamplifier
- **New** Capillary TC Design
- **New** Non-Metallic Solution Ground

Applications

- Water and Wastewater Treatment
- Coagulation and Flocculation
- Process Monitoring and Control
- Acid / Caustic Neutralization
- Plant Effluent



Description

The Model 21 process pH sensor features the Plunger pH electrode design which permits 360° sensor mounting. The porous Teflon[®] liquid junction resists fouling and chemical attack. Double junction reference cells increase the service life in applications containing sulfides (H₂S) and metals such as lead, mercury and silver. The new cast-in-place solid reference electrolyte helps maintain a constant reference cell potential by resisting dilution over time with pressure and temperature changes. The new capillary temperature sensor design places the Pt100 TC behind the pH sensitive membrane for accurate temperature compensation and measurement. The IP68 environmental rating protects the high impedance pH electrode signal from moisture resulting from condensate build up in submersion pipes.

Specifications

Model 21	Specifications
Body Material	Ryton [®]
O-Rings	Viton [®]
Measuring Range	0 to 14 pH
Temperature Range	0 to 80°C (32 to 176°F) Standard Version 0 to 110°C (32 to 230°F) High Temp Version
Pressure Range	0 to 6.9 bar (0 to 100 psig) Standard Version 0 to 10.3 bar (0 to 150 psig) High Temp Version
Drift	< 2.0 mV/week
Response Time @ 25°C	95% of reading in 10 seconds
Asymmetry Potential	7.0 pH ± 0.2 pH
Theoretical Slope	± 59.16 mV / pH unit @ 25°C (77°F)
Sodium Error	< 0.05 pH in 0.1 Molar Na ⁺ Ion @ 12.8 pH
pH Glass Bulb Impedance @ 25°C	150 Megohms

¹ United States Patent No. 4,333,812

² United States Patent No. 4,128,468

[®] Teflon and Viton are Registered Trademarks of E.I. DuPont de Nemours Company

[®] Ryton is a registered trademark of Philips 66 Co.



INNOVATIVE SENSORS INC.
REGISTERED TO ISO 9001
CERTIFICATE NO. 00-1011



Fax: (714) 779-9315
Telephone: (714) 779-8781
In The U.S.: (800) 835-5474



Innovative Sensors Inc.
4745 East Bryson Street
Anaheim, CA 92807-1901
Nov. 2000

Model 21 Process pH Sensor

Ordering Information

Model 21 pH sensor features a protective pH electrode guard and provides an insertion length of 58.4mm (2.3").

Model 21 and 17 Ordering Information	Description
M - 21	Process pH Sensor with Protective Guard Double Junction Reference Cell, KCl/AgCl and KNO ₃ No Temperature Compensation 3/4" MNPT Process Connections 58.4 mm (2.3") Insertion Length 4.6m (15 ft.) Cable
Options	Description
PT100	Temperature Compensation, 100 Ohm RTD
HT	For continuous high temperature use, >80°C (176°F)
M-21-PT100-HT	Example Order Number

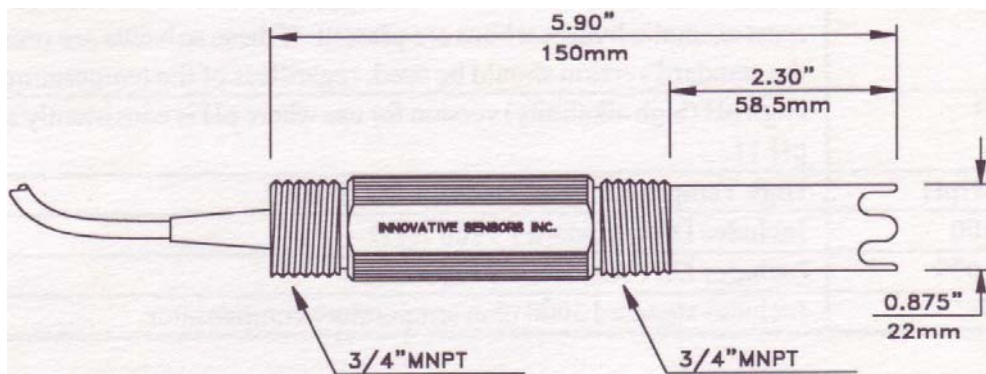

Flow Installation

- 1" NPT Pipe Tee (By Others)
- 3/4" Reducing Bushing (By Others)
- Use Teflon® Tape on Sensor to permit removal for routine maintenance
- Install shut off valves upstream and downstream of sensor
- Optimum flow rate is 3 to 5 GPM
- Sensor must remain in solution at all times

Note: Variations in design of plastic plumbing parts from different manufactures can be expected. Check tolerances prior to installation.