

HORIBA

Instruction Manual

pH/ORP/DISSOLVED OXYGEN METER

LAQUA-PD210

LAQUA-PD220

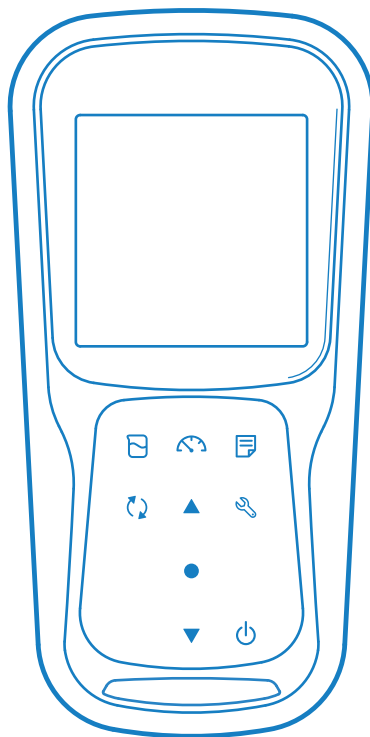

LAQUA
Portable pH • Water Quality Meter

• Preface

This manual describes the operation of the following instrument.

| | |
|--------------------|---|
| Brand: | LAQUA |
| Series name: | LAQUA 200 Series Handheld Water Quality Meter |
| Model: | LAQUA-PD210, LAQUA-PD220 |
| Model description: | pH/ORP/Dissolved Oxygen Meter |

Be sure to read this manual before using the product to ensure proper and safe operation of the product. Also, safely store the manual so it is readily available whenever necessary. Product specifications and appearance, as well as the contents of this manual are subject to change without notice.

• Warranty and responsibility

HORIBA Advanced Techno Co., Ltd. warrants that the product shall be free from defects in material and workmanship and agrees to repair or replace free of charge, at option of HORIBA Advanced Techno Co., Ltd., any malfunctioned or damaged product attributable to responsibility of HORIBA Advanced Techno Co., Ltd. for a period of Three (3) years from the delivery unless otherwise agreed in a written statement. In any one of the following cases, none of the warranties set forth herein shall be extended:

- Any malfunction or damage attributable to improper operation
- Any malfunction attributable to repair or modification by any person not authorized by HORIBA Advanced Techno Co., Ltd.
- Any malfunction or damage attributable to the use in an environment not specified in this manual
- Any malfunction or damage attributable to violation of the instructions in this manual or operations in the manner not specified in this manual
- Any malfunction or damage attributable to any cause or causes beyond the reasonable control of HORIBA Advanced Techno Co., Ltd. such as natural disasters
- Any deterioration in appearance attributable to corrosion, rust, and so on
- Replacement of consumables

HORIBA Advanced Techno Co., Ltd. SHALL NOT BE LIABLE FOR ANY DAMAGES RESULTING FROM ANY MALFUNCTIONS OF THE PRODUCT, ANY ERASURE OF DATA, OR ANY OTHER USES OF THE PRODUCT.

• Trademarks

- Microsoft, Windows, Windows Vista are registered trademarks or trademarks of Microsoft Corporation in the United States and other countries.

Other company names and brand names are either registered trademarks or trademarks of the respective companies. (R), (TM) symbols may be omitted in this manual.

Regulations

- **Regulations**

- **EU regulations**

- **Conformable standards**

This equipment conforms to the following standards:



| | |
|--------------|---|
| EMC: | EN61326-1 Class B, Basic electromagnetic environment |
| RoHS: | EN50581 9. Monitoring and control instruments |

Warning: This product is not intended for use in industrial environments. In an industrial environment, electromagnetic environmental effects may cause the incorrect performance of the product in which case the user may be required to take adequate measures.

- **Information on disposal of electrical and electronic equipment and disposal of batteries and accumulators**

The crossed out wheeled bin symbol with underbar shown on the product or accompanying documents indicates the product requires appropriate treatment, collection and recycle for waste electrical and electronic equipment (WEEE) under the Directive 2012/19/EU, and/or waste batteries and accumulators under the Directive 2006/66/EC in the European Union. The symbol might be put with one of the chemical symbols below. In this case, it satisfies the requirements of the Directive 2006/66/EC for the object chemical. This product should not be disposed of unsorted household waste. Your correct disposal of WEEE, waste batteries and accumulators will contribute to reducing wasteful consumption of natural resources, and protecting human health and the environment from potential negative effects caused by hazardous substance in products.

Contact your supplier for information on applicable disposal methods.



- **Authorised representative in EU**

HORIBA UK Limited
Kyoto Close, Moulton Park,
Northampton, NN3 6FL, United Kingdom

Regulations

• FCC rules

FCC Compliance Statement

This device complies with part 15 of the FCC Rules. Operation is subject to the following two conditions: (1) This device may not cause harmful interference, and (2) this device must accept any interference received, including interference that may cause undesired operation.

Responsible Party for FCC matter

HORIBA Instruments Incorporated
Head Office
9755 Research Drive
Irvine, California 92618 USA
+1 949 250 4811

Note

This equipment has been tested and found to comply with the limits for a Class A digital device, pursuant to part 15 of the FCC Rules. These limits are designed to provide reasonable protection against harmful interference when the equipment is operated in a commercial environment. This equipment generates, uses, and can radiate radio frequency energy and, if not installed and used in accordance with the instruction manual, may cause harmful interference to radio communications. Operation of this equipment in a residential area is likely to cause harmful interference in which case the user will be required to correct the interference at his own expense.

Any changes or modifications not expressly approved by the party responsible for compliance could void the user's authority to operate the equipment.

• Korea certification

B급 기기 (가정용 방송통신기자재)

이 기기는 가정용(B 급) 전자파적합기기로서 주로 가정에서 사용하는 것을 목적으로 하며, 모든 지역에서 사용할 수 있습니다.

• Taiwan battery recycling marks



廢電池請回收

Regulations

• China regulation

标记的意义 Meaning of Marking

本标记适用在中华人民共和国销售电器电子产品，标记中央的数字表示环境保护使用期限的年数。（不是表示产品质量保证期间。）只要遵守这个产品有关的安全和使用注意事项，从制造日开始算起在这个年限内，不会给环境污染、人体和财产带来严重的影响。请不要随意废弃本电器电子产品。



This marking is applied to electric and electronic products sold in the People's Republic of China. The figure at the center of the marking indicates the environmental protection use period in years. (It does not indicate a product guarantee period.) It guarantees that the product will not cause environment pollution nor serious influence on human body and property within the period of the indicated years which is counted from the date of manufacture as far as the safety and usage precautions for the product are observed. Do not throw away this product without any good reason.

Regulations

产品中有害物质的名称及含量

Name and amount of hazardous substance used in a product

| 部件名称 Unit name | 有害物质 Hazardous substances | | | | | |
|---------------------------|------------------------------|---------------------------|---------------------------|---|---|--|
| | 铅 Lead (Pb) | 汞 Mer- cury (Hg) | 镉 Cad- mium (Cd) | 六价铬 Hexa- valent chromium (Cr (VI)) | 多溴联苯 Poly bromobi- phenyl (PBB) | 多溴二苯醚 Poly bromo- diphenyl ether (PBDE) |
| 本体 Main unit | × | ○ | ○ | ○ | ○ | ○ |
| 电池 Battery | × | ○ | ○ | ○ | ○ | ○ |
| AC 适配器 AC adopter*1,*2 | × | ○ | ○ | ○ | ○ | ○ |
| 电缆 Cable*2 | × | ○ | ○ | ○ | ○ | ○ |
| 支架 Stand*2 | ○ | ○ | ○ | ○ | ○ | ○ |
| 打印机 Printer*2 | × | ○ | ○ | ○ | ○ | ○ |
| 电极 Electrode*2 | × | ○ | × | ○ | ○ | ○ |

本表格依据 SJ/T 11364 的规定编制。

This form is prepared in accordance with SJ/T 11364.

○：表示该有害物质在该部件所有均质材料中的含量均在 GB/T 26572 规定的限量要求以下。

Denotes that the amount of the hazardous substance contained in all of the homogeneous materials used in the component is below the limit on the acceptable amount stipulated in the GB/T 26572.

×：表示该有害物质至少在该部件的某一均质材料中的含量超出 GB/T 26572 规定的限量要求。

Denotes that the amount of the hazardous substance contained in any of the homogeneous materials used in the component is above the limit on the acceptable amount stipulated in the GB/T 26572.

*1: 本部件的环保使用期限为 10 年。 The environmental protection use period of this product is 10 years.

*2: 选配件 Optional products

For Your Safety

- **For Your Safety**

- **Hazard classification and warning symbols**

Warning messages are described in the following manner. Read the messages and follow the instructions carefully.

- **Hazard classification**

 **DANGER**

This indicates an imminently hazardous situation which, if not avoided, will result in death or serious injury. This is to be limited to the most extreme situations.

 **WARNING**

This indicates a potentially hazardous situation which, if not avoided, could result in death or serious injury.

 **CAUTION**

This indicates a potentially hazardous situation which, if not avoided, may result in minor or moderate injury. It may also be used to alert against unsafe practices.

- **Warning symbols**



Description of what should be done, or what should be followed.



Description of what should never be done, or what is prohibited.

For Your Safety

- **Safety precautions**

This section provides precautions for using the product safely and correctly and to prevent injury and damage. The terms of DANGER, WARNING, and CAUTION indicate the degree of immanency and hazardous situation. Read the precautions carefully as it contains important safety messages.

- **Instrument and electrode**

WARNING



Do not disassemble or modify the instrument. Otherwise, it may heat up or be ignited resulting in a fire or an accident.

CAUTION



Harmful chemicals

Some electrodes are used with hazardous standard solutions. Handle them with care. The internal solution of pH electrode is highly concentrated potassium chloride (3.33 mol/L KCl) and internal solution of DO electrode is highly concentrated potassium hydroxide (KOH). If the internal solution comes in contact with the skin, wash it off immediately. If it gets into the eyes, flush with plenty of water and then consult a doctor.



Broken glass

Broken glass may cause injury. The outer tube and tip of an electrode are made of glass. Handle them with care.



Do not use the phono jack under wet or humid conditions. Otherwise, it may cause a fire, electric shock, or breakage.

For Your Safety

• Battery

WARNING



Keep batteries out of reach of children. If someone accidentally swallows a battery, consult a doctor immediately.



If alkaline fluid from a battery gets into the eyes, do not rub the eyes, rinse with clean water immediately and then consult a doctor. Contact with alkaline fluid could cause blindness.



Do not put batteries in a fire, expose to heat, disassemble or remodel. Doing so can cause fluid leakage, overheating or explosion.

Product Handling Information

• Product Handling Information

• Operational precautions (instrument)

- Only use the product including accessories for their intended purpose.
- Do not drop or physically impact the instrument.
- The instrument is made of solvent-resistant materials but that does not mean it is resistant to all chemicals. Do not expose the instrument in strong acid or alkali solution, or wipe with such solution.
- If the instrument is dropped into water or gets wet, wipe it using soft cloth. Do not heat to dry it.
- The instrument has a dust-proof and waterproof structure i.e., the instrument does not malfunction even when immersed in water of 1 m depth for 30 minutes. This does guarantee non-destructive, trouble-free, dust-proof, and waterproof performance in all situations.
- When replacing the batteries or when a serial cable connected, the instrument does not have the dust-proof and waterproof performance. The dust-proof and waterproof performance is maintained only when the covers are attached correctly.
- After replacing the batteries or removing the serial cable connected, make sure that the waterproof gasket attached to the cover is not deformed or discolored, or has foreign matter adhering to it. If the waterproof gasket is deformed, discolored or has foreign matter adhering to it, dust could get inside, water leaks could occur that could lead to instrument malfunction.
- To disconnect an electrode or serial cable, hold the connector and pull it off. If you pull at the cable, it may cause breakage.
- The phono jack communication between the instrument and a personal computer (referred to as PC in the rest of this document) may fail because of environmental conditions, such as electromagnetic noise.
- Do not replace the batteries in a dusty place or with wet hands. Dust or moisture could get inside the instrument, possibly causing instrument malfunction.
- Do not use an object with a sharp end to press the keys.
- If the power supply is interrupted while measurement data is being saved in the instrument, the data could be corrupted.
- A Ni-MH rechargeable battery can be used in this instrument.

• Operational precautions (battery)

- Do not short circuit a battery.
- Position the + and – side of the battery correctly.
- When the battery has depleted or the instrument will not be used for a long time, remove the batteries.
- Of the specified battery types, make sure to use two batteries of the same type.
- Do not use a new battery together with a used battery.
- Do not use a fully charged nickel-metal hydride battery together with a partially charged battery.
- Do not attempt to charge a non-rechargeable battery.

Product Handling Information

- **Environmental conditions for use and storage**

- Temperature: 0 °C to 45 °C
- Humidity: under 80% relative humidity and free from condensation

- **Avoid the following conditions:**

- Strong vibration
- Direct sunlight
- Corrosive gas environment
- Locations close to an air-conditioner
- Direct wind

- **Transportation**

When transporting the instrument, repackage it in the original package box. Otherwise, it may cause instrument damage.

- **Disposal**

- Standard solution used for the calibration must be under neutralized before the disposal.
- When disposing of the product, follow the related laws and regulations of your country for disposal of the product.

Contents

| | |
|---|----|
| ■ Product Overview | 1 |
| ● Package Content..... | 1 |
| ● Key Features | 2 |
| ● Product components | 3 |
| ■ Basic operations | 7 |
| ● Mode and measurement..... | 9 |
| ■ Calibration | 11 |
| ● pH Calibration | 11 |
| ● ORP/mV Calibration..... | 13 |
| ● DO Calibration..... | 15 |
| ● Temperature Calibration | 21 |
| ■ Data | 23 |
| ● Data capture and storage..... | 23 |
| ● Data transfer..... | 24 |
| ■ Setup | 25 |
| ● P1 pH setup | 25 |
| ● P1 DO setup | 29 |
| ● P2 Data setup | 33 |
| ● P3 General setup | 40 |
| ● P4 CLK setup | 49 |
| ■ Maintenance and storage | 54 |
| ● Maintenance and storage of the instrument | 54 |

Contents

| | |
|---|----|
| • Maintenance and storage of electrodes | 55 |
| ■ Error messages and trouble shooting | 57 |
| ■ Appendix | 62 |
| • Appendix 1 | 62 |
| • Appendix 2 | 65 |
| • Appendix 3 | 65 |

■ Product Overview

This section describes the package content, key features and product components of LAQUA PD200 handheld meters.

● Package Content

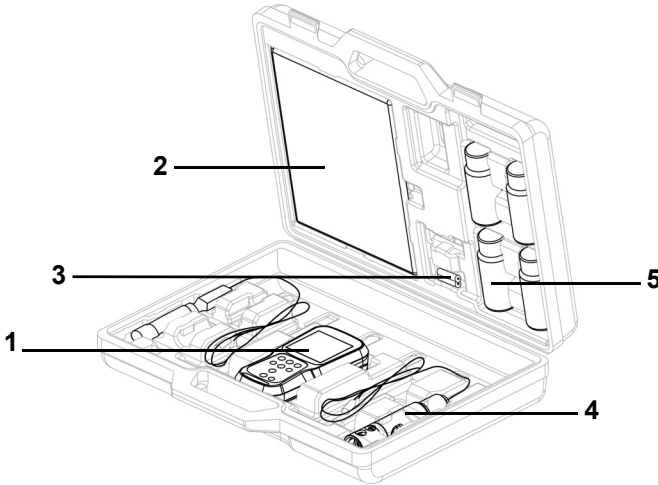

After opening the carry case, remove the meter and check for damage on the instrument and confirm that the standard accessories all exist. If damage or defects are found on the product, contact your dealer.

LAQUA PD200 Series Handheld meter and meter kit include the following items:

| S.NO. | Name |
|-------|-----------------------|
| 1 | Instrument |
| 2 | Instruction manual |
| 3 | 2 AA batteries |
| 4 | Electrodes |
| 5 | Calibrating solutions |

● Key Features

- IP67 water ingress, dust-proof, shock-resistant, anti-slip meter housing.
- Large monochrome LCD (50 x 50 mm) with white LED back lighting.
- Built-in electrode holder (up to 2 electrodes).
- Foldable meter stand.
- Simple user interface and single parameter display.
- 500 (for PD210) / 1000 (for PD220) data memory.
- Automatic Temperature Compensation (ATC) with temperature calibration.
- Adjustable auto shut-off time (1 to 30 minutes).
- Auto-hold / Auto stable / Real-time measurement modes with stability indicator.
- Powered by 2 x AA batteries.
- Real-time clock (only for PD220).
- PC (standard USB) / Printer (25 pin serial) connection via 2.5 mm diameter phono jack.



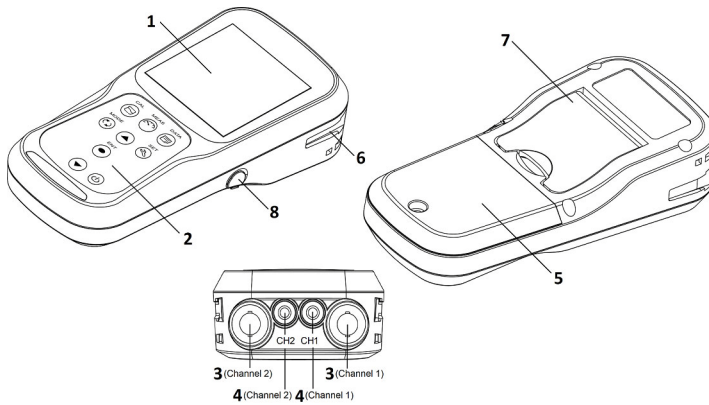



● Product components

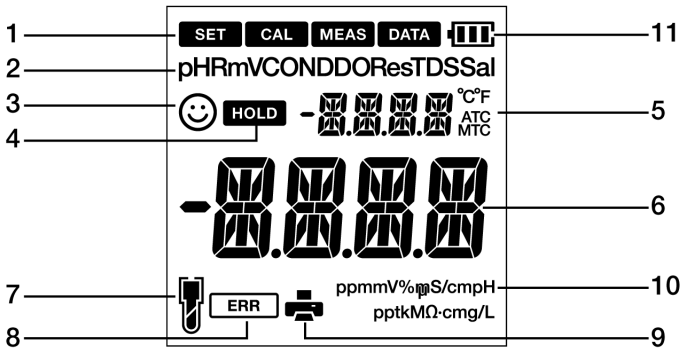





| No | Name | Function |
|----|---------------------------|---|
| 1 | Monochrome LCD | Displays the measured value |
| 2 | Operation keys | Used for instrument operation |
| 3 | Electrode connector | Connect to the BNC connector of the electrode |
| 4 | Temperature connector (T) | Connect to the temperature sensor of the electrode |
| 5 | Battery cover | Open/close to insert/remove batteries |
| 6 | Electrode holder | Hold the electrode to carry with the instrument |
| 7 | Meter stand | Open stand to place the meter at an inclined position on a flat surface |
| 8 | Serial connector | Connects the serial cable and printer cable |

• Display





| No | Name | Function |
|----|---|--|
| 1 | Status Icon | Displays the current operation mode (Setup, Calibration, Measurement and Data mode) |
| 2 | Parameters | Displays the measured parameters like pH, RmV, and DO |
| 3 |  | Stability indicator shows value is stable for documentation in Auto Stable and Auto Hold modes |
| 4 |  | Appears when the measured value display is stable and fixed in auto-hold mode |
| 5 | Temperature display area | Displays the measured temperature |
| 6 | Measured value, set item display area | Displays the measured value and the set value |
| 7 |  | Indicates electrode sensitivity level |
| 8 |  | Indicates error situation |
| 9 |  | Indicates data being transferred to the printer or computer |
| 10 | ppmmV%µmS/cm pH pptkMΩ·cmg/L | Displays the unit for the measurement parameter |
| 11 |  | Displays the battery level |

- **Battery level display**

| | |
|---|---|
|  | 100% battery life |
|  | 50% battery life |
|  | 20% battery life |
|  | Batteries are weak and need replacement. Refer " BATT LOW " (page 57) to solve this |

- **Electrode sensitivity level**

| | |
|---|--|
|  | Electrode sensitivity above 95%(excellent) |
|  | Electrode sensitivity between 85% to 95% (very good) |
|  | Electrode sensitivity between 80% to 85%(good). Refer " SLPE ERR " (page 57) to solve this |

● **Keypad operation**

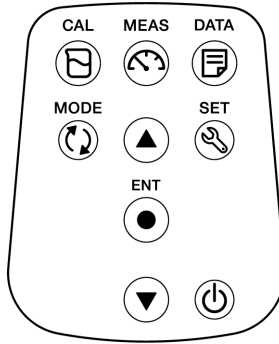

| Keypad | Name | Function |
|--------|-----------|--|
| | CAL key | Switches from the measurement mode to the calibration mode. Starts calibration in the calibration mode. |
| | MEAS key | Switches the operation mode to the measurement mode. Releases the fixed measurement value mode in the auto hold mode and begins a fresh measurement. |
| | DATA key | Switches from the measurement mode to the data mode. |
| | MODE key | In the measurement mode, changes measurement parameters. |
| | SET key | Switches from the measurement mode to the setup mode. |
| | ENTER key | Determines the selection or setup. Saves data in the measurement mode and calibration mode. |
| | UP key | In the setup mode, navigates between various setups. Selects preferred option in some setup screens. |
| | DOWN key | Increases or decreases selected digit when entering numbers. |
| | POWER key | Powers ON/OFF the instrument. |

■ Basic operations

This section describes function and basic operation method of each part of LAQUA PD200 handheld meter.

● Turning on the instrument

Inserting the batteries

This instrument is operated by batteries. You can use AA alkaline batteries or AA Ni- MH chargeable batteries. Perform the following procedure to insert batteries in the instrument.

1. Unscrew the battery cover on the back of the instrument counter-clock wise to unlock the battery cover.
2. Remove the battery cover and set the batteries inside.
3. Replace battery cover.
4. Screw the battery cover on the back of the instrument clockwise to lock the battery cover.

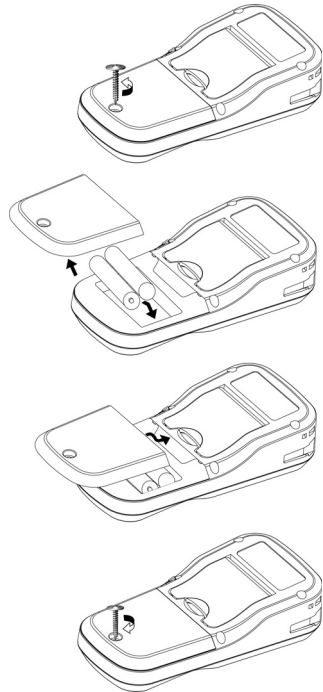

Note

- Do not replace the batteries in a dusty place or with wet hands. Dust or moisture could get inside the instrument and possibly cause an instrument malfunction.
- Do not short-circuit a battery.
- Note polarity as shown in the battery compartment.
- When the battery has depleted or the instrument is not used for a long time, remove the batteries.
- Of the specified battery types, make sure to use two batteries of the same type.
- Do not use a new battery together with an used battery.

● **Connecting an electrode**

To perform calibration/ measurement, it is necessary to use the appropriate electrode for measurement parameter. Recommended electrodes for various sample are listed in our product catalog. Use the following procedure to correctly connect the electrode to the instrument:

1. Insert the electrode connector by fitting its groove with the connector pin of the instrument (refer below table).
2. Turn the electrode connector clockwise by following the grooves.
3. Slide the connector cover on the connector.
4. When using a combination electrode equipped with a temperature sensor, insert the temperature jack (T) to the ATC socket on the meter.

| | |
|--------------|--------------|
| CH1 | CH2 |
| pH Electrode | DO Electrode |

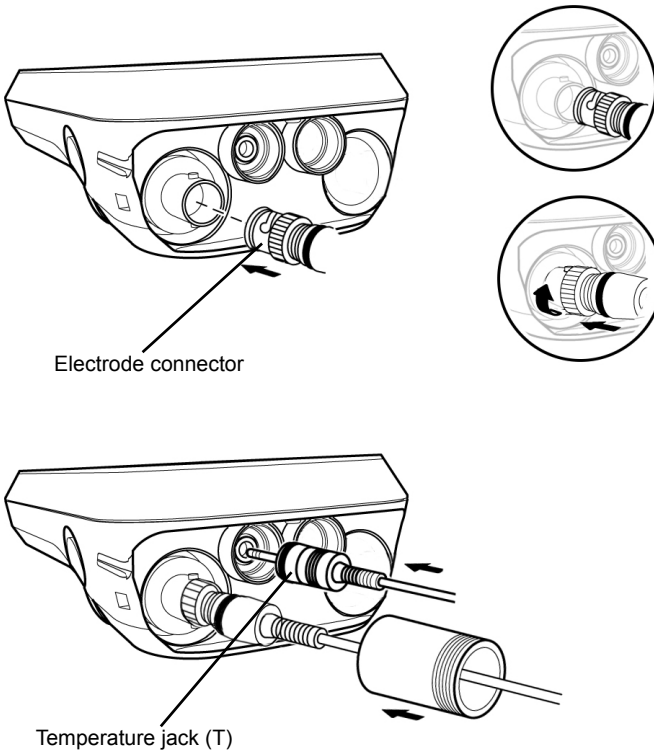





- **Mode and measurement**





- **Changing the operation mode**

You can change the operation mode to four available modes depending on the purpose of use. The status icon indicates the current mode.

Status icons —    

| Icon | Name | Function |
|---|------------------|---|
|  | Setup mode | Perform various setup functions. |
|  | Calibration mode | Performs calibration. |
|  | Measurement mode | Performs measurement. |
|  | Data mode | Performs data setup. Displays the saved data. |

You can change the operation mode using the corresponding key:

- **Measurement mode:** Press the  key to change to the measurement mode.
- **Calibration mode:** In the measurement mode, press the  key to change to the calibration mode.
- **Data mode:** In the measurement mode, press the  key to change to the data mode.
- **Setup mode:** In the measurement mode, press the  key to change to the setup mode.

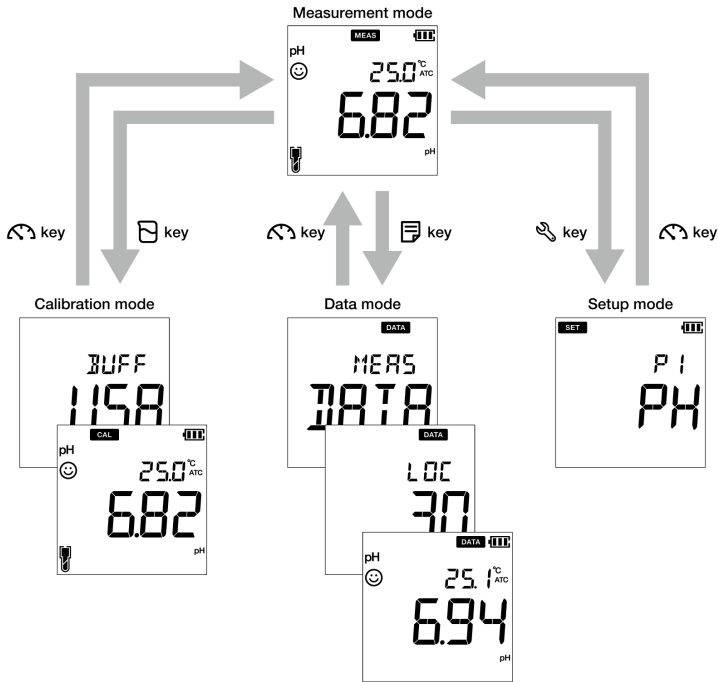

• **Changing the measurement parameter**

This instrument measures multiple parameters. For measurement, an electrode corresponding to the measurement parameter is required. In the measurement mode, the measurement parameter can be changed by pressing the **key**.

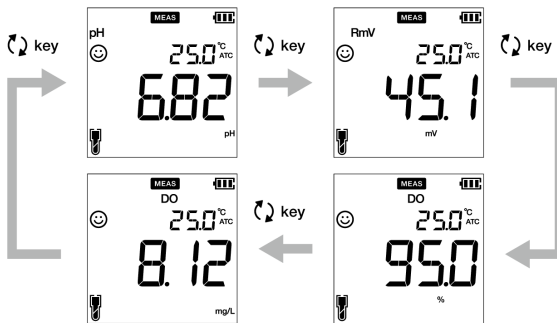

■ Calibration

This section describes the basic calibration method using LAQUA PD200 handheld meter, pH electrode and DO electrode.

● pH Calibration

Calibration is necessary for accurate pH measurement. To perform pH calibration, follow the procedure detailed below.

Prerequisites

- Clean the pH electrode with DI (deionized) water and wipe it with tissue paper.
- Switch on the PD meter and plug in the pH electrode.
- Prepare buffer solution required for calibration.
- Keep the meter in pH measurement mode.
- Dip the pH electrode at least 3 cm in the buffer solution.





Note

- Perform two-point calibration using:
pH 7 and 4 for acidic sample.
pH 7 and 10 for alkaline sample.
 - Perform three-point calibration using pH7, 4 and 10 if you are unsure of the expected sample pH value. It is recommended to calibrate with pH7 first.
 - Default buffer setup is **BUFF USA**. If you want to change to **BUFF NIST** or **BUFF DIN**, refer to “P 1.1 Buffer selection” on page 26.
-

Tip

- To abort an ongoing calibration process at any point of time, press the  key.
 - It is recommended to clear the previous calibration data before performing calibration. For erasing the calibration data, refer to “P 1.3 Erase calibration data” on page 28.
-

Calibration

1. After placing the pH electrode in the buffer solution, press the  key.
2. The selected buffer standard appears on the meter screen and meter starts checking various calibration values with a blinking  on screen.
3. Wait for the  to stabilize (stable calibration reading).
4. Press the **ENT**  key to confirm and save calibration data.
5. Meter displays **DONE** indicating end of the pH calibration procedure.
6. Repeat for other calibration points as required.

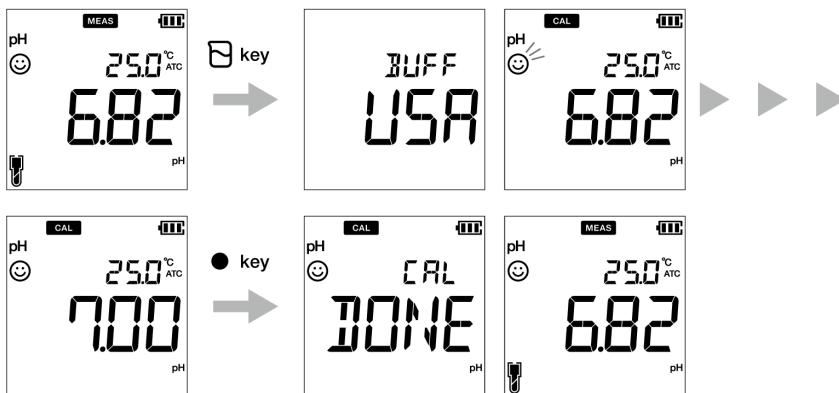

Note

If you want to know previous calibrated values, press the  key when you are in the **CAL** mode. The display scrolls through the calibrated values and indicates slope and offset values.

● ORP/mV Calibration

Calibration is necessary for accurate ORP measurement. To perform ORP calibration, follow the procedure detailed below:

Prerequisites

- Clean the ORP electrode with DI (deionized) water and wipe it with tissue paper.
- Switch on the PD meter and plug in the ORP electrode.
- Prepare buffer solution required for calibration.
- Ensure that the meter is in mV measurement mode.
- Dip the ORP electrode into the standard solution ensuring that the solution level is at least 3 cm from the electrode tip.







Note

- Absolute value measurement mode and relative value measurement mode are the two types of measurement mode available for ORP (mV) measurement.
- In absolute value measurement mode, the handheld meter displays the actual voltage value.
- In relative value measurement mode, user can adjust the absolute mV value by calibration. If the mV value is adjusted, the meter automatically indicates relative mV value as **RmV**. The adjustment mV is applied as an offset to the absolute mV value.
- In the relative mV mode, the absolute mV value can be adjusted by ± 200 mV.

Tip

To abort an ongoing calibration process at any point of time, press the  key.

Calibration

1. After placing the electrode in the solution, press the  key to switch to mV mode.
2. Press the  key.
3. Meter starts reading mV values and the  blinks until value stabilizes.
4. Wait for the  to stabilize (stable calibration reading).
5. Use the   keys to adjust the mV value to your desired value.
6. Press the **ENT**  key to confirm and save calibration data.
7. Meter displays **DONE** that indicates end of the ORP/mV calibration procedure.

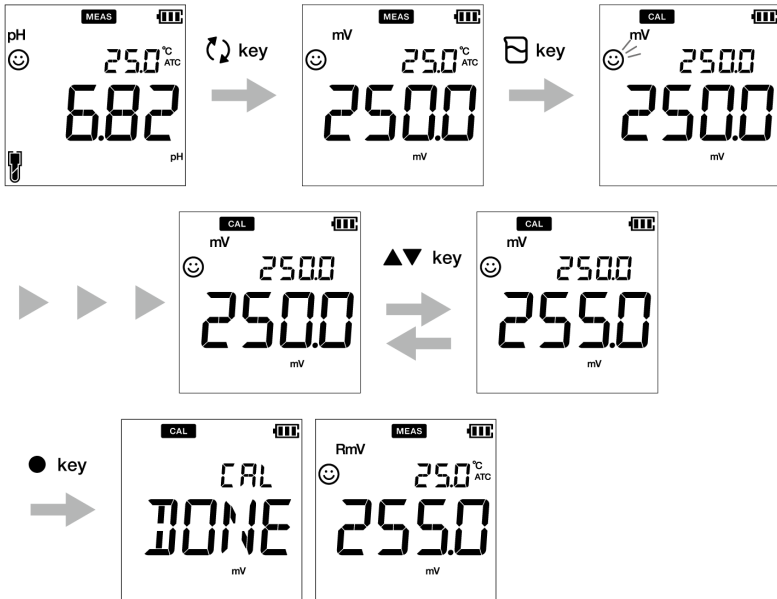

• DO Calibration

Calibration is necessary for accurate dissolved oxygen measurement. Two DO calibration modes are available in PD meter for calibration,

- Saturated oxygen concentration mode (%)
- Dissolved oxygen measurement mode (mg/L)

To perform various DO calibrations, follow the procedures detailed below:

Note

Set the air pressure value (default setup is 101.3 kPa) before calibration for accurate measurement.

• Calibration in saturated oxygen concentration mode (%)

Prerequisites

- Clean the membrane at the tip of the DO electrode with DI (deionized) water and wipe it with tissue paper.
- Switch on the PD meter and plug in the DO electrode.
- Press the  key to keep the PD meter in saturated oxygen concentration mode (%) mode.





Note

- Calibration performed in clean air is referred as air calibration.
 - Perform the air calibration in clean air at a location not subjected to dramatic temperature change, rain or direct wind.
 - Do not hold the tip of DO electrode with hand during calibration, as the electrode may be affected by temperature causing instability in calibration value.
-

Tip

To abort an ongoing calibration process at any point of time, press the  key.

• **Air calibration**



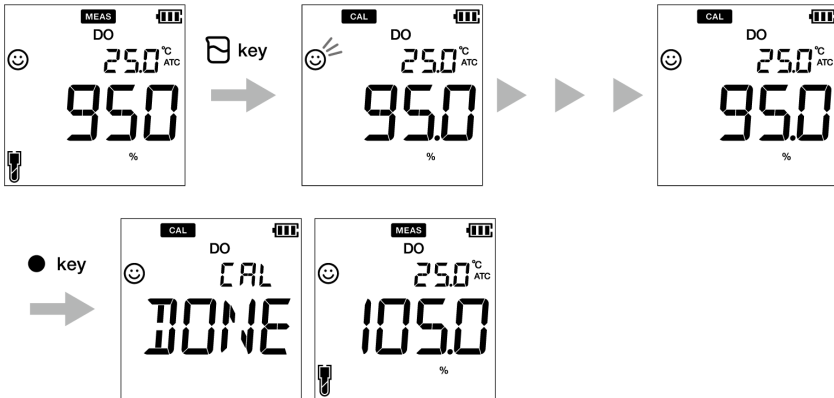

1. Hold the DO electrode still in clean air.
2. Press the  key. Meter starts checking various calibration values with a blinking  on screen.
3. Wait for the  to stabilize (stable calibration reading).
4. Press the **ENT**  key to confirm and save calibration data.
5. Meter displays **DONE** indicating end of the air calibration procedure.

Note

The electrode responds slightly differently to atmospheric air as compared to water. As such, 100% calibration in air will be shown as approximately 105%. Don't be alarmed by this. The reading in water will be accurate.



• Zero calibration

1. Dip the DO electrode in the zero standard solution.
2. Press the  key. Meter starts checking various calibration values with a blinking  on screen.
3. Wait for the  to stabilize (stable calibration reading).
4. Press the  key again to move to Zero Calibration mode.
5. Press the **ENT**  key to confirm and save calibration data.
6. Meter displays **DONE** indicating end of the zero calibration procedure.

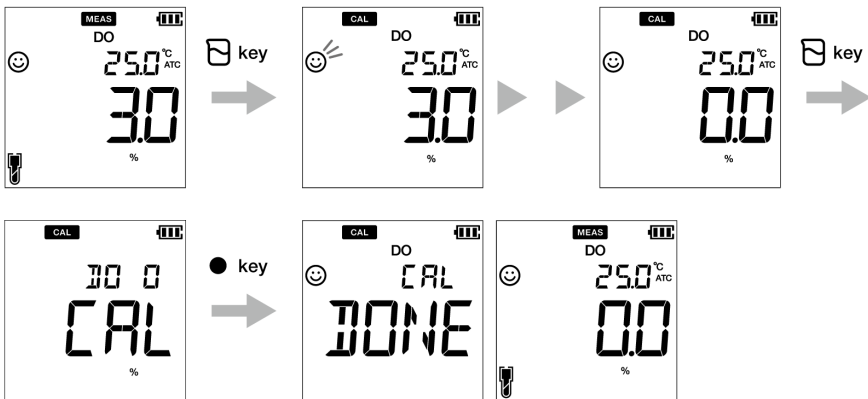

Note

- Calibration performed with zero standard solution is referred as zero calibration.
- Prepare zero standard solution by adding 50 g sodium sulfite (Na_2SO_3) to 1000 mL deionized water and stirring the mixture to completely dissolve the Na_2SO_3 .

• Calibration in dissolved oxygen measurement mode (mg/L)

Prerequisites

- Clean the membrane at the tip of the DO electrode with DI (deionized) water and wipe it with tissue paper.
- Prepare required standard solutions (high-concentration and low-concentration solutions).
- Switch on the PD meter and plug in the DO electrode.
- Dip the DO electrode at least 6 cm in the standard solution.
- Press the  key to keep the PD meter in dissolved oxygen measurement mode (mg/L) mode.







Note

- Calibrate in the dissolved oxygen measurement mode in the order from high-concentration solution to a low-concentration solution.
 - User can adjust the measured dissolved oxygen reading by calibration and the adjusted value is applied as an off set to the actual measurement.
 - Prepare high-concentration solution by aerating a sample of fresh water for about 2 hours.
-

Tip





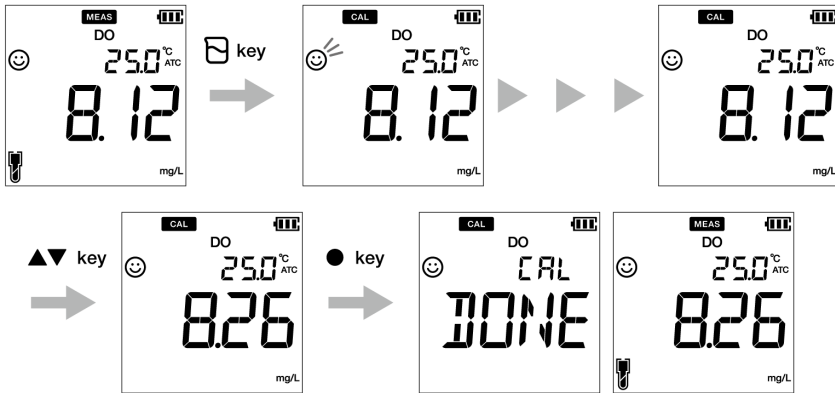

To abort an ongoing calibration process at any point of time, press the  key.

● 1st point calibration

1. After placing the DO electrode in the high concentration solution, press the  key.
Meter starts checking various calibration values with a blinking  on screen.
2. Wait for the  to stabilize (stable calibration reading).
3. Use the   keys to adjust the DO reading.
4. Press the **ENT**  key to confirm and save calibration data.
5. Meter displays **CAL DONE** indicating end of the calibration procedure.



● 2nd point calibration

1. After placing the DO electrode in the low concentration solution (zero standard solution), press the  key. Meter starts checking various calibration values with a blinking  on screen.
2. Wait for the  to stabilize (stable calibration reading).
3. Press the  key again to move to Zero Calibration Mode.
4. Use the   keys to adjust the DO reading.
5. Press the **ENT**  key to confirm and save calibration data.
6. Meter displays **CAL DONE** indicating end of the calibration procedure.

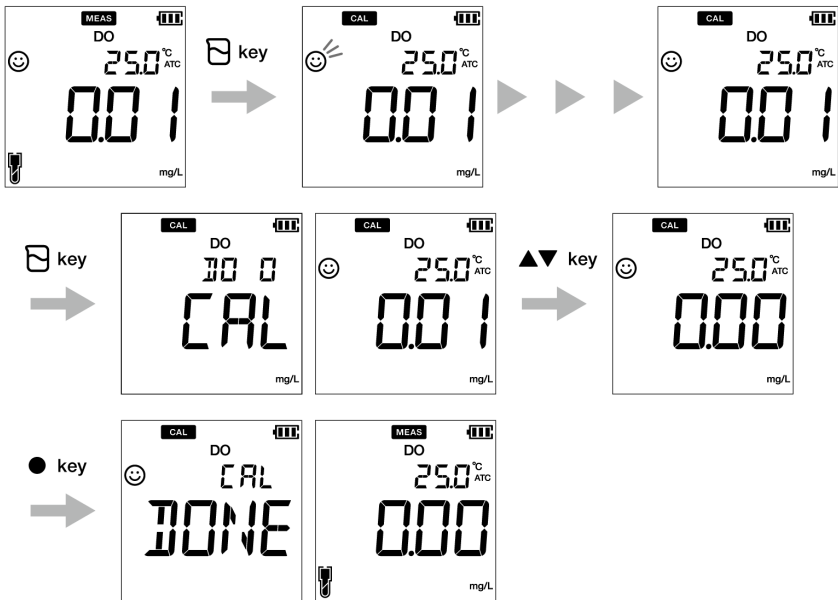

• Temperature Calibration

Temperature calibration is required to accurately match pH or DO electrode to the meter. Check the temperature reading and if its acceptable, no temperature calibration is required. If you need to calibrate, please follow the procedure detailed below:

Prerequisites

- Clean the pH or DO electrode with DI (deionized) water and wipe it with tissue paper.
- Switch on the PD meter and plug in any of the electrodes and the temperature sensor.
- Dip the electrode in any calibrating solution till its temperature sensor is immersed.
- Wait for 5 minutes to ensure temperature stability.





Note

- Meter displays **MTC** if the temperature sensor is not plugged in and displays **ATC** if the temperature sensor is plugged in.
- Temperature calibration must be performed using a known temperature solution or against a calibrated thermometer.

Tip

To abort an ongoing calibration process at any point of time, press the  key.

Calibration

1. After placing the electrode in the solution, press the  key.
2. Press the  key to switch to temperature calibration mode. Meter displays measured temperature value.
3. Use the   keys to adjust the temperature to the required value.
4. Press the **ENT**  key to save calibration data.
5. Meter displays **DONE** indicating end of the temperature calibration procedure.

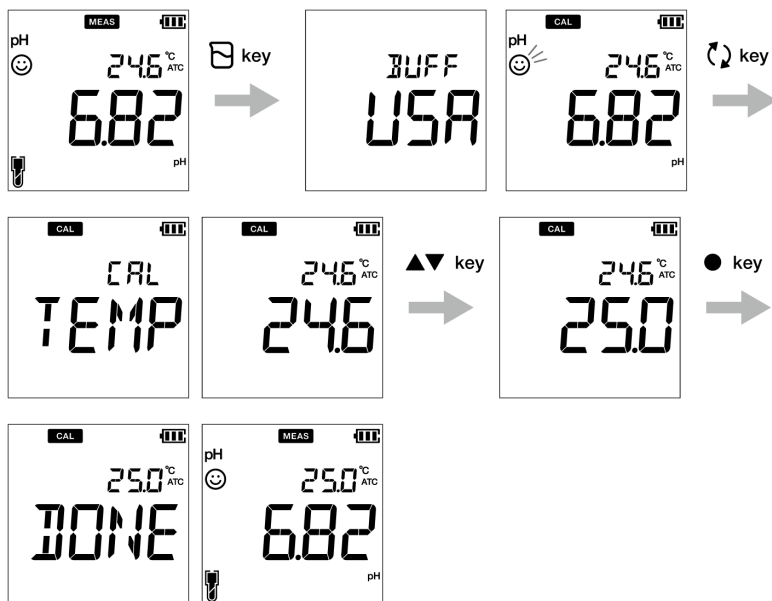

■ Data

This section describes the basic method of data transferring using LAQUA 200 handheld meters.

● Data capture and storage

In LAQUA PD200 handheld meters, data measured by the instrument can be stored in the internal memory.

To save the measured data:



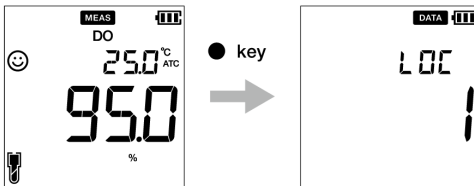

- Press the **ENT**  key to save the displayed data.
- Meter displays the saved data for 2 seconds and then the display returns to the previous screen automatically.



Note

- If the data storage limit reaches 500 in PD210 model or 1000 in PD220 model, memory full error occurs and **MEM FULL** is displayed.
- In such case, print the data or transfer necessary data to a PC (only for PD220) and delete the data from the internal memory of the instrument.

Viewing stored data

- To view stored data, press  key .
- Use   keys to review different stored records.
- Press  key to return to measurement mode.

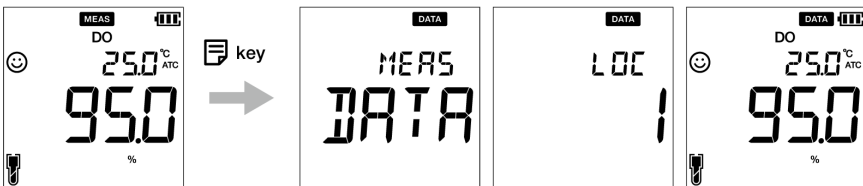





● Data transfer

● Transfer data to PC

Connect the instrument to a PC using the phono plug to USB cable to transfer saved data to the PC (for LAQUA PD220 only). Connect the phono jack at the instrument side to the communication port on the PC.

● Print data

To print a desired data set:

1. When the instrument is in the measurement mode, press  key.
2. Use   keys to view desired stored data.
3. Press  key to print that individual data.

● Printer format- measurement

| | |
|------------------|----------------|
| Meter Model | : HORIBA PD220 |
| Serial Number | : 123456789 |
| SW Revision | : 1.00 |
| User Name | : |
| Signature | : |
| Logged Data | |
| Location | : 2 |
| Date | : 10 Aug 2018 |
| Time | : 10:10:28 |
| Mode | : pH |
| pH | : 7.00 pH |
| mV | : 0.0 mV |
| Temperature | : 25.0 C (MAN) |
| Electrode Status | : Excellent |
| Location | : 1 |
| Date | : 10 Aug 2018 |
| Time | : 10:09:28 |
| Mode | : mV |
| mV | : 178.0 mV |
| Temperature | : 25.0 C (MAN) |

Tip

To print entire stored data log, refer "P 2.2 Print data setup" on page 36.

■ Setup

This section describes all the setup functions available in LAQUA PD200 handheld meters.

● P1 pH setup

Using P1 pH setup function of the meter, you can:

- Select buffer standard
- Set calibration alarm
- Erase calibration data

To set the pH functions using LAQUA PD200 handheld meter, follow the procedure detailed below:

Prerequisites

Switch on the PD meter.







Note

- Default buffer setup is **BUFF USA**. You can change it to **BUFF NIST** or **BUFF DIN** if required.
 - Calibration alarm setup option must be used to avoid “Calibration interval alarm error” on page 57 . You can set the calibration alarm for ---- day to upto 90 days, where ---- indicates “no calibration alarm” has been set.
 - Erasing previous calibration data is recommended for accurate calibration. Default setup is **NO** but to erase the calibration data, you need to change the setup to **YES**.
-

Tip





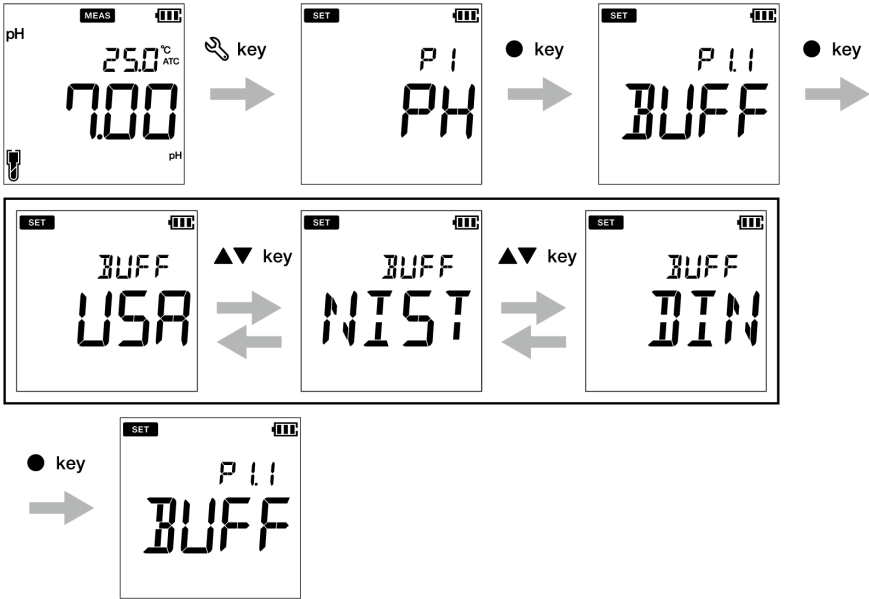

To return to the measurement mode, press the  key.

● **P 1.1 Buffer selection**

1. Press the  key, **P1 PH** screen appears.
2. Press the **ENT**  key, **P1.1 BUFF** screen appears.
3. Press the **ENT**  key, by default **BUFF USA** appears.
4. Use the   keys to change the buffer standard to **BUFF NIST** or **BUFF DIN**.
5. Press the **ENT**  key, **P1.1 BUFF** screen appears. This indicates completion of buffer selection.







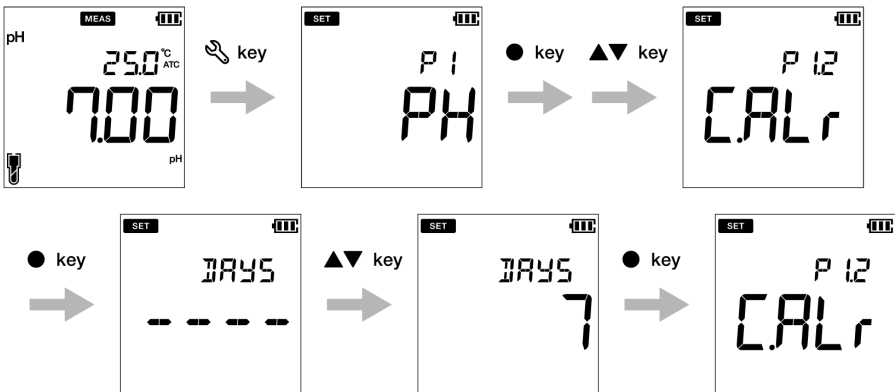



• P 1.2 Calibration alarm setup

1. Press the  key, **P1 PH** screen appears.
2. Press the **ENT**  key, **P1.1 BUFF** screen appears.
3. Press the  key, **P1.2 C.ALr** screen appears.
4. Press the **ENT**  key, by default **DAYS ----** appears.
5. Use the   keys to adjust the calibration alarm interval for next calibration.
6. Press the **ENT**  key, **P1.2 C.ALr** screen appears. This indicates completion of calibration alarm setup.



● **P 1.3 Erase calibration data**

1. Press the  key, **P1 PH** screen appears.
2. Press the **ENT**  key, **P1.1 BUFF** screen appears.
3. Press the  key, **P1.2 C.ALr** screen appears.
4. Press the  key, **P1.3 C.CLr** appears.
5. Press the **ENT**  key, **C.CLr NO** screen appears with **NO** as default setup.
6. Use the   keys to change the setup to **YES**. This erases the calibration data.
7. Press the **ENT**  key. **P1.3 C.CLr** screen appears. This indicates erasure of calibration data.

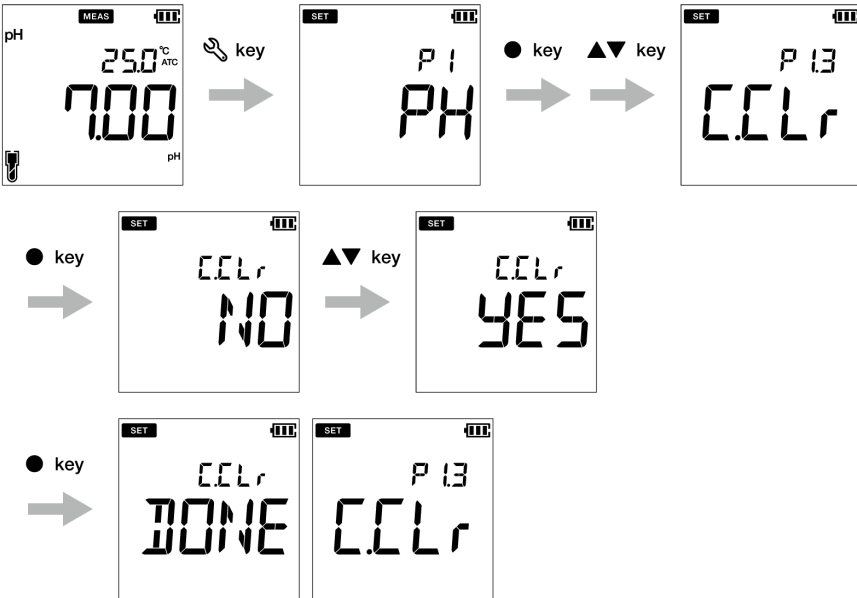

● P1 DO setup

Using P1 DO setup function of the meter, you can:

- Set salinity value
- Set barometric pressure
- Erase calibration data

To set the DO functions using LAQUA PD200 handheld meter, follow the procedure detailed below:

Prerequisites

Switch on the PD meter.







Note

- Default salinity value is **0.0 ppt**. You can set a value in between 0.0 to 40.0 ppt.
 - Default barometric pressure is **101.3 kPa**. You can set a value in between 10.0 to 200.0 kPa.
 - Erasing previous calibration data is recommended for accurate calibration. Default setup is **NO** but to erase the calibration data, you need to change the setup to **YES**.
-

Tip





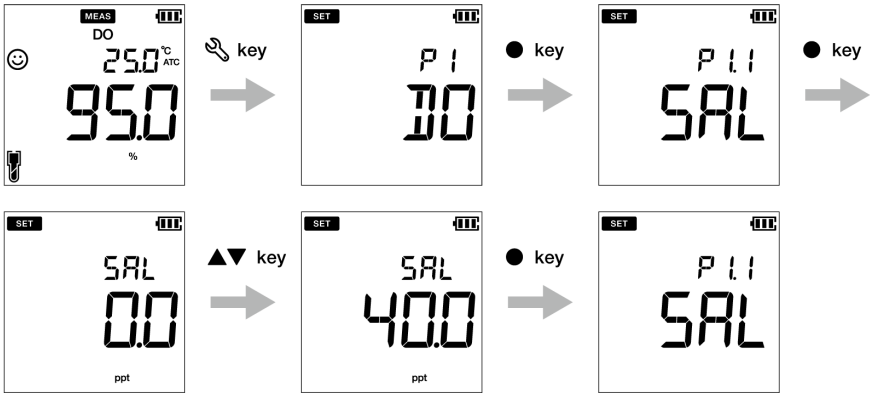

To return to the measurement mode, press the  key.

● **P1.1 Salinity value setup**

1. Press the  key, **P1 DO** screen appears.
2. Press the **ENT**  key, **P1.1 SAL** screen appears.
3. Press the **ENT**  key, by default **SAL 0.0 ppt** appears.
4. Use the   keys to adjust the salinity value in between 0.0 to 40.0 ppt.
5. Press the **ENT**  key, **P1.1 SAL** screen appears. This indicates completion of salinity value setup.





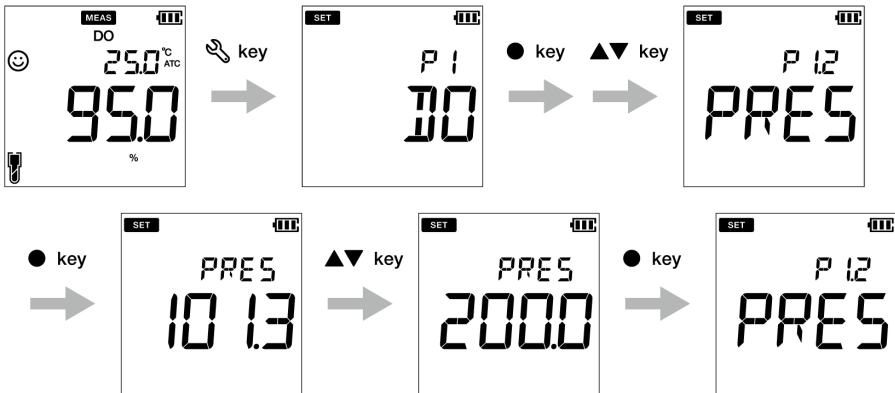

• P1.2 Barometric pressure setup

1. Press the  key, **P1 DO** screen appears.
2. Press the **ENT**  key, **P1.1 SAL** screen appears.
3. Press the  key, **P1.2 PRES** screen appears.
4. Press the **ENT**  key, by default **PRES 101.3** appears.
5. Use the   keys to adjust the barometric pressure in between 10.0 to 200.0 kPa.
6. Press the **ENT**  key, **P1.2 PRES** screen appears. This indicates completion of barometric pressure setup.



● **P1.3 Erase calibration data**

1. Press the  key, **P1 DO** screen appears.
2. Press the **ENT**  key, **P1.1 SAL** screen appears.
3. Press the **▲** key, **P1.2 PRESS** screen appears.
4. Press the **▲** key, **P1.3 C.Clr** appears.
5. Press the **ENT**  key, **C.Clr NO** screen appears with **NO** as default setup.
6. Use the **▲** **▼** keys to change the setup to **YES**. This erases the calibration data.
7. Press the **ENT**  key. **P1.3 C.Clr** screen appears. This indicates erasure of calibration data.

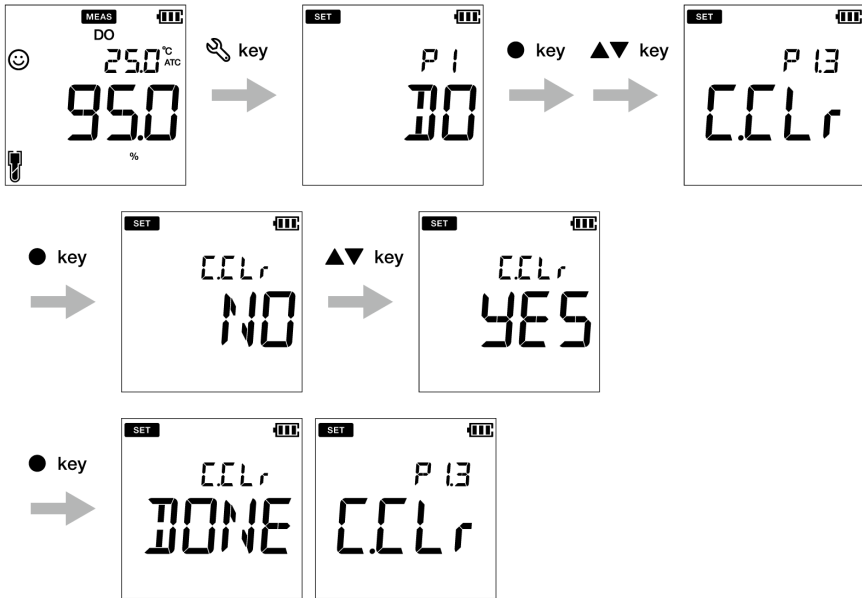

● P2 Data setup

Using P2 Data setup function of the meter, you can:

- Set data log interval
- Print data log
- Erase data log

To set the data functions using LAQUA PD200 handheld meter, follow the procedure detailed below:

Prerequisites

- Switch on the PD meter.
- Keep the meter either in pH or DO mode.







Note

- Data setup procedure is common in both pH and DO mode with different meter screen display based on available setup sequence.
 - Default data log interval is ----, where ---- indicates “no data log interval” has been set.
 - Data log interval can be set from 2 to 999 seconds.
-

Tip

To return to the measurement mode, press the  key.

• P 2.1 Data log interval setup

1. Press the  key, P1 PH/DO screen appears.
2. Press the  key, P2 DATA screen appears.
3. Press the **ENT**  key, P2.1 LOG screen appears.
4. Press the **ENT**  key, previously set log interval appears.
5. Use the  keys to sets the data log interval.
6. Press the **ENT**  key, P2.1 LOG screen appears. This indicates completion of data log interval setup.



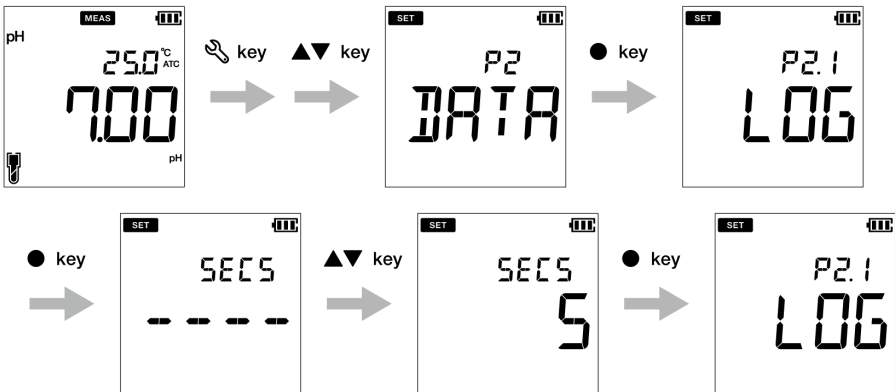



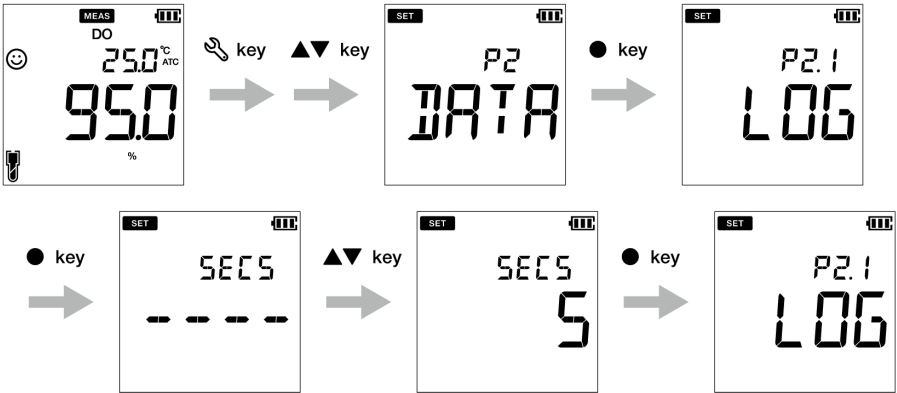

pH mode



DO mode



● **P 2.2 Print data setup**

1. Press the  key, **P1 PH/DO** screen appears.
2. Press the  key, **P2 DATA** screen appears.
3. Press the **ENT**  key, **P2.1 LOG** screen appears.
4. Press the  key, **P2.2 PrNT** screen appears.
5. Press the **ENT**  key, default setup is **NO**.
6. Use the   keys to change the setup to **YES**.
7. Press the **ENT**  key, **P2.2 PrNT** screen appears. This indicates completion of the print data.



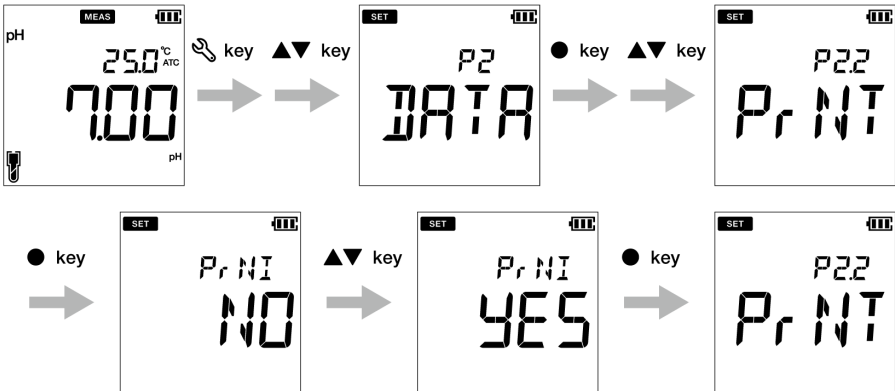



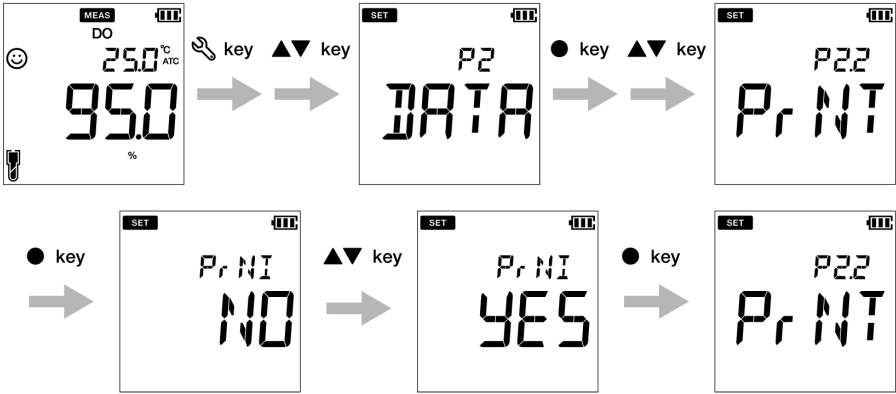

pH mode



DO mode



● **P2.3 Erase data**

1. Press the  key, **P1 PH/DO** screen appears.
2. Press  key, **P2 DATA** screen appears.
3. Press the **ENT**  key, **P2.1 LOG** screen appears.
4. Press the  key, **P2.2 PRNT** screen appears.
5. Press the  key, **P2.3 D.CLR** screen appears.
6. Press the **ENT**  key, default setup is **NO**.
7. Use the   keys set it to **YES** to erase all the data.
8. Press the **ENT**  key, **D.CLR DONE** screen appears briefly and then **P2.3 D.CLR** screen appears. This indicates completion of erasure of data.

pH mode

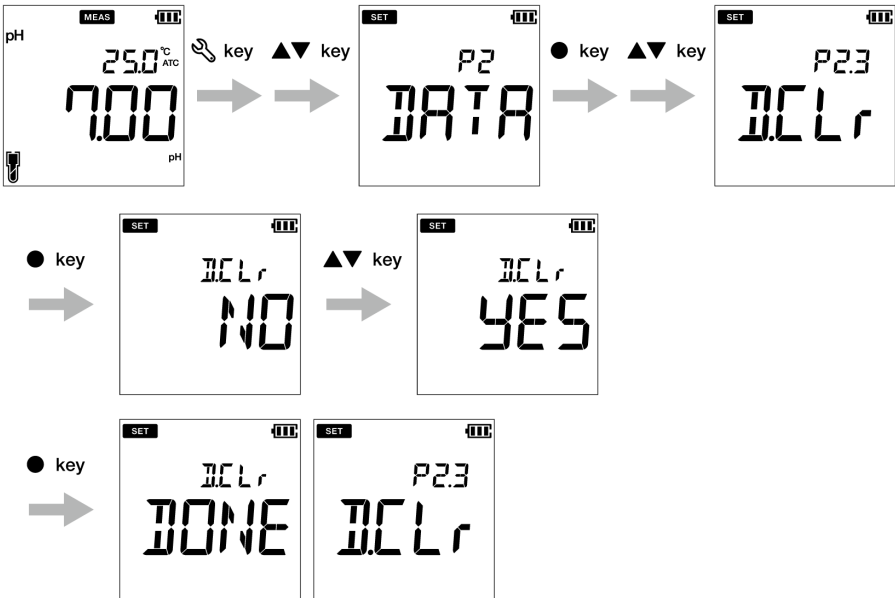

DO mode

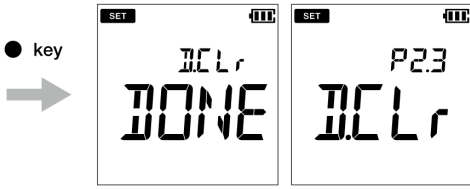
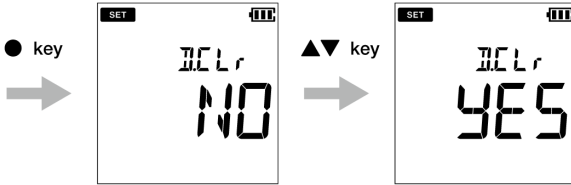

• P3 General setup

Using P3 General setup function of the meter, you can:

- Select stability mode of the meter
- Set auto shut-off time
- Select temperature measurement
- Reset the meter

To set the general functions using LAQUA PD200 handheld meter, follow the procedure detailed below:

Prerequisites

- Switch on the PD meter.
- Keep the meter either in pH or DO mode

Note

- General setup procedure is common in both pH and DO mode with different meter screen display based on available setup sequence.
- In the calibration mode, the auto stable (**AS**) mode is activated. Default stability setup in measurement mode is “auto stable” (**AS**). If you like, you can change it to “auto hold” (**AH**) or “real time” (**RT**).
- Default auto shut-off time is 30 minutes. You can set the time from ---- to 30 minutes, where ---- indicates “no auto shut-off time” has been set and meter will be on continuously.
- Default temperature unit is °C and you can change the unit to °F.
- Default reset meter setup is **NO**. If you like to reset the meter, you can change it to **YES**.

Tip









- Stability judgment criteria remains same for both auto stability mode and auto hold mode.
 - To return to the measurement mode, press the  key.
-

● **P 3.1 Auto Stable, Auto Hold and Real Time mode setup**

Auto Stable (AS) mode - the meter shows live readings ☺ annunciator blinks until the reading is stable.

Auto Hold (AH) mode - the meter locks the stable reading; ☺ annunciator blinks until reading is stable and then **HOLD** lights up.

Real Time (RT) mode - the meter shows live readings; Both ☺ and **HOLD** annunciators are inactive.

1. Press the  key, **P1 PH/DO** screen appears.
2. Press  key, **P2 DATA** screen appears.
3. Press  key, **P3 GEN** screen appears.
4. Press the **ENT**  key, **P3.1 STBL** screen appears.
5. Press the **ENT**  key, Default the stability mode is **AS** (auto stable).
6. Use the   keys to change the stability mode as **AH** (auto hold) or **RT** (real time).
7. Press the **ENT**  key, **P3.1 STBL** screen appears. This indicates completion of the stability mode selection.



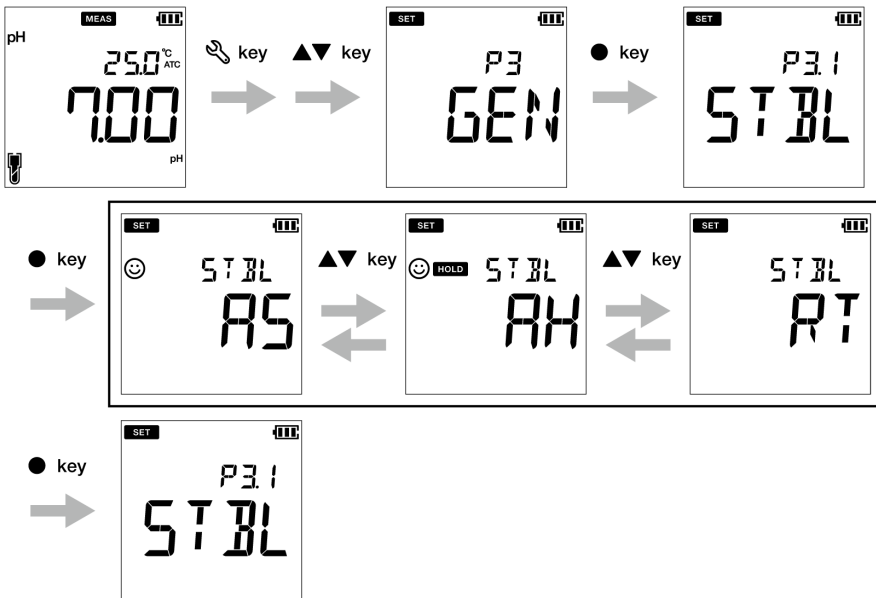



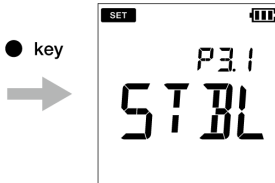
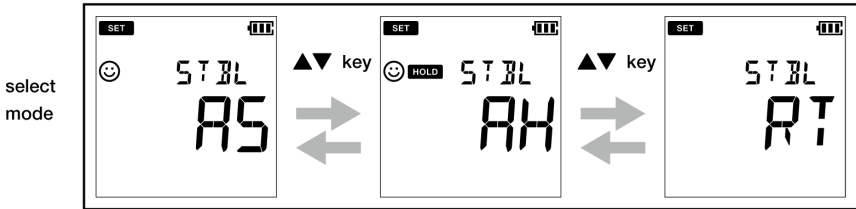
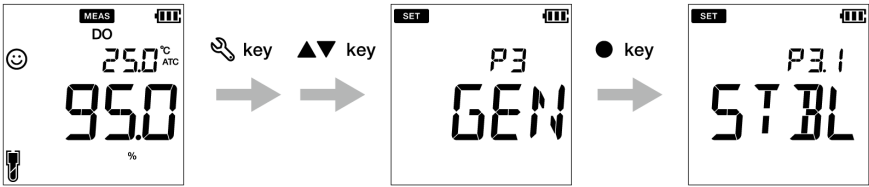

pH mode



DO mode



• P 3.2 Auto shut-off time setup

1. Press the  key, **P1 PH/DO** screen appears.
2. Press the  key, **P2 DATA** screen appears.
3. Press the  key, **P3 GEN** screen appears.
4. Press the **ENT**  key, **P3.1 STBL** screen appears.
5. Press the  key, **P3.2 A.OFF** screen appears.
6. Press the **ENT**  key, default auto shut-off time is **30 minutes**.
7. Use the   keys to adjust the auto off time.
8. Press the **ENT**  key, **P3.2 A.OFF** screen appears. This indicates completion of the auto shut-off time setup.

Note

The default shut off time is 30 minutes. This can be adjusted from 1 minute to 30 minutes. If you set the display to '----' it indicates Auto Off is disabled. Meter will be on indefinitely till the user switches off the meter.



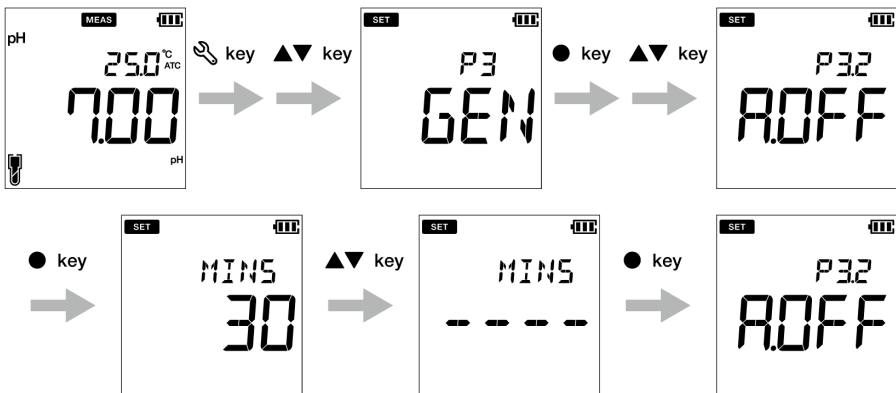



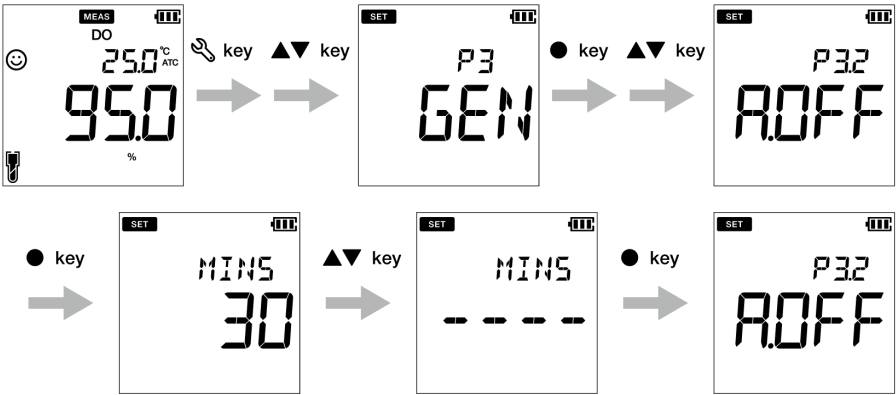



pH mode



DO mode



● **P 3.3 Temperature unit setup**

1. Press the  key, **P1 PH/DO** screen appears.
2. Press the  key, **P2 DATA** screen appears.
3. Press the  key, **P3 GEN** screen appears.
4. Press the  key, **P3.1 STBL** screen appears.
5. Press the  key, **P3.2 A.OFF** screen appears.
6. Press the  key, **P3.3°C°F** screen appears.
7. Press the **ENT**  key, default temperature unit is **°C**.
8. Use the   keys to change the unit to **°F**.
9. Press the **ENT**  key, **P3.3°C°F** screen appears. This indicates completion of the end temperature unit selection.



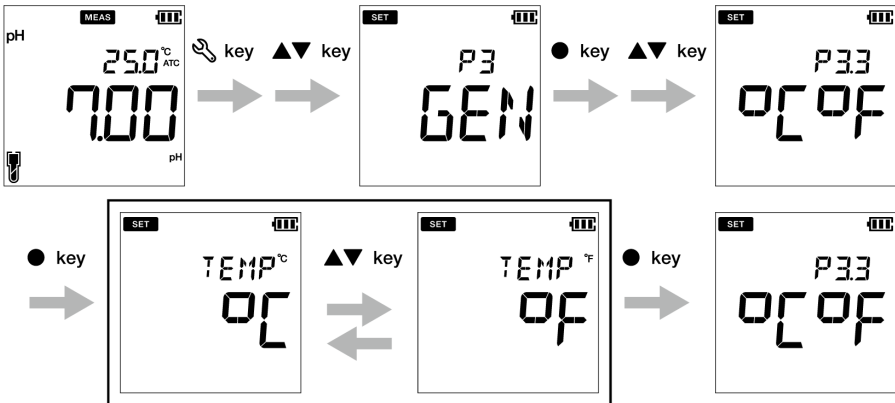



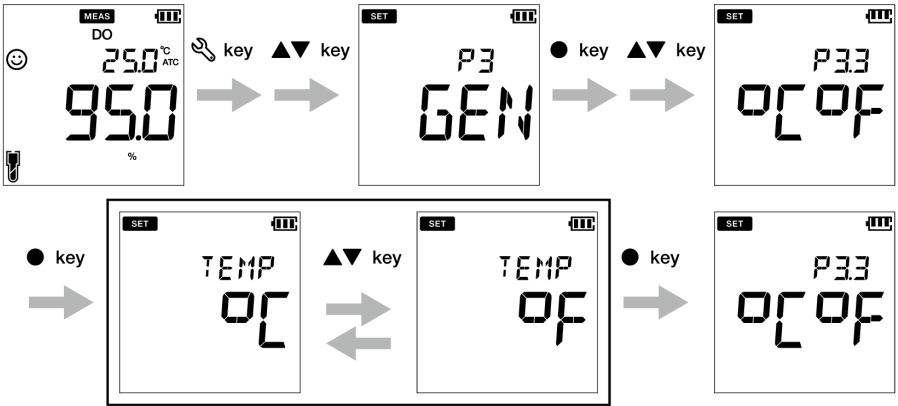



pH mode



DO mode



● **P 3.4 Reset meter (factory default)**

1. Press the  key, **P1 PH/DO** screen appears.
2. Press the  key, **P2 DATA** screen appears.
3. Press the  key, **P3 GEN** screen appears.
4. Press the **ENT**  key, **P3.1 STBL** screen appears.
5. Press the  key, **P3.2 A.OFF** screen appears.
6. Press the  key, **P3.3 °C°F** screen appears.
7. Press the  key, **P3.4 r.SET** screen appears.
8. Press the **ENT**  key, default meter re-setup is **NO**.
9. Use the   key to set it **YES**.
10. Press the  key. Meter displays **DONE** and automatically switches off.

pH mode

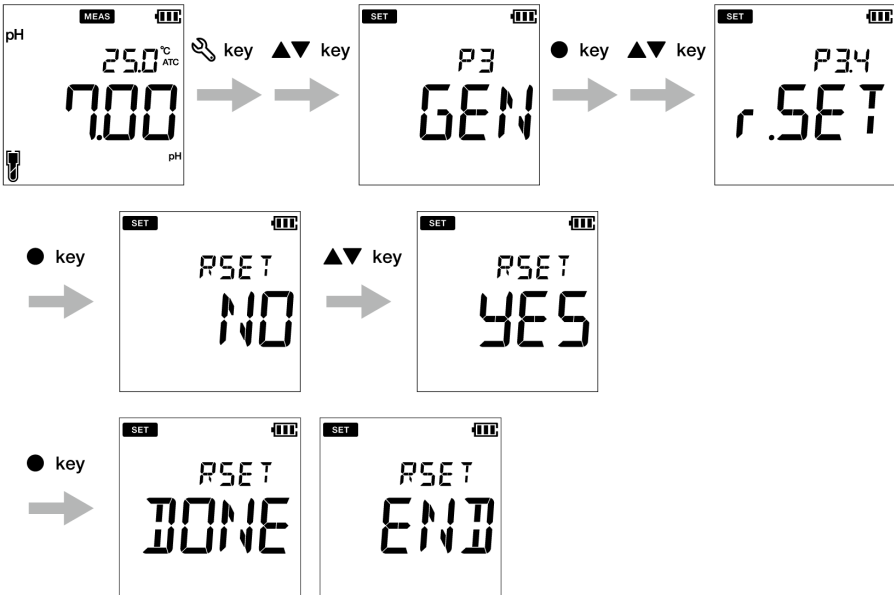

DO mode

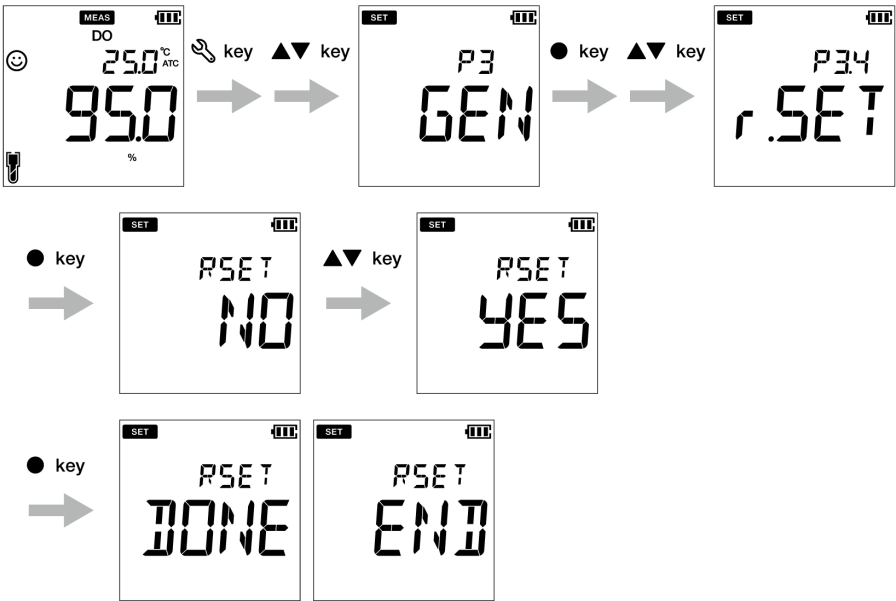

● P4 CLK setup

Real-time clock functionality is available only for LAQUA 220 meters. Using P4 Clock setup function of the meter, you can set:

- Date
- Time

To set the clock function using LAQUA PD220 handheld meter, follow the procedure detailed below:

Prerequisites

- Switch on the PD meter.
- Keep the meter either in pH or DO mode















Note

- Clock setup procedure is common in both pH and DO mode with different meter screen display based on available setup sequence.
 - setup date and time is necessary before using the instrument for the first time or after replacing the batteries.
 - Set date and time data is captured correctly while saving data in the internal memory.
-

Tip

To return to the measurement mode, press the  key.

• P 4.1 Date setup

1. Press the  key, P1 PH/DO screen appears.
2. Press the  key, P2 DATA screen appears.
3. Press the  key, P3 GEN screen appears.
4. Press the  key, P4 CLK screen appears.
5. Press the ENT  key, P4.1 DATE screen appears.
6. Press the ENT  key, default set year appears.
7. Use the   keys to adjust the year,
8. Press the ENT  key, default set month appears.
9. Use the   keys to adjust the month.
10. Press the ENT  key, default set day appears.
11. Use the   keys to adjust the day.
12. Press the ENT  key, P4.1 DATE screen appears. This indicates completion of the date setup.



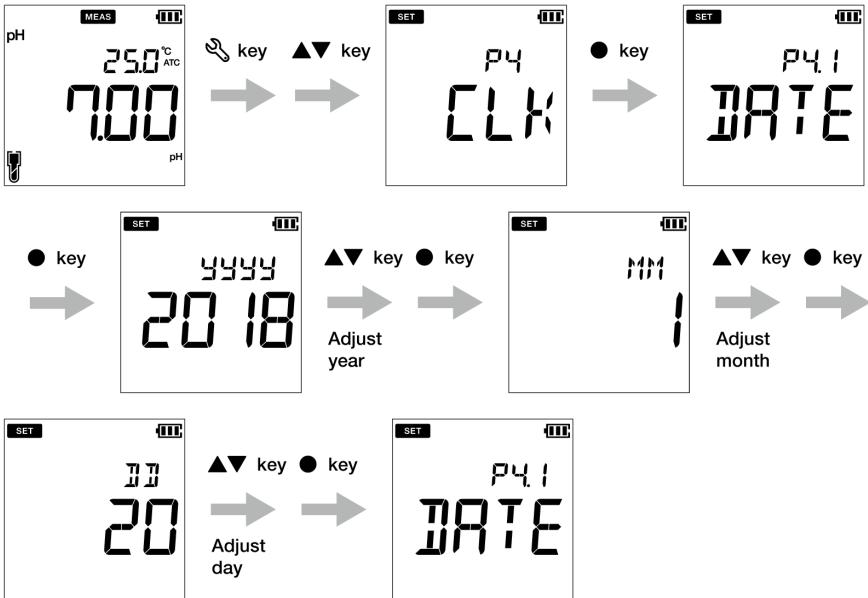



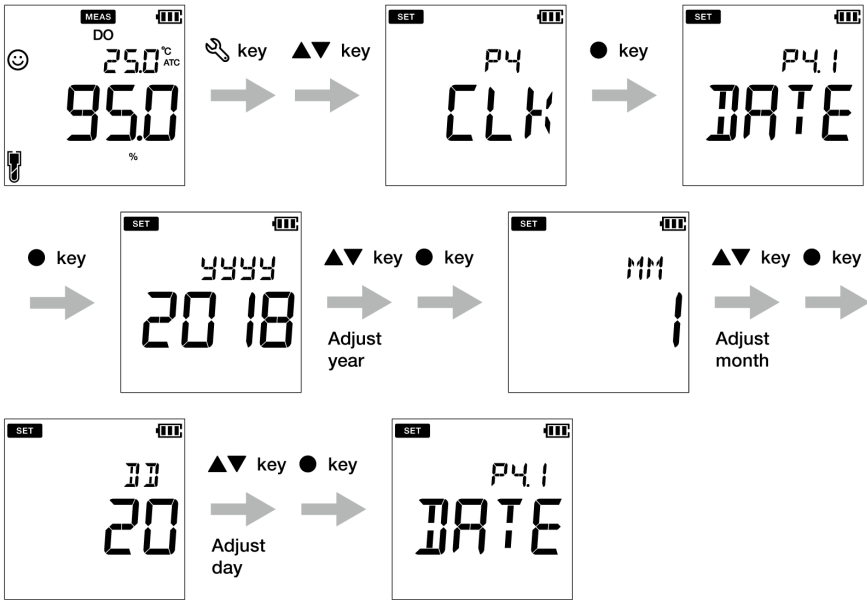





pH mode



DO mode



• P 4.2 Time setup

1. Press the  key to switch to the setup mode, **P1 PH/DO** screen appears.
2. Press the  key, **P2 DATA** screen appears.
3. Press the  key, **P3 GEN** screen appears.
4. Press the  key, **P4 CLK** screen appears.
5. Press the **ENT**  key, **P4.1 DATE** screen appears.
6. Press the  key, **P4.2 TIME** screen appears.
7. Press the **ENT**  key, default set hour appears.
8. Use the   keys to adjust the hour.
9. Press **ENT**  key, default set minute appears.
10. Use the   keys to adjust the minute.
11. Press **ENT**  key, **P4.2 TIME** screen appears. This indicates completion of the time setup.

pH mode

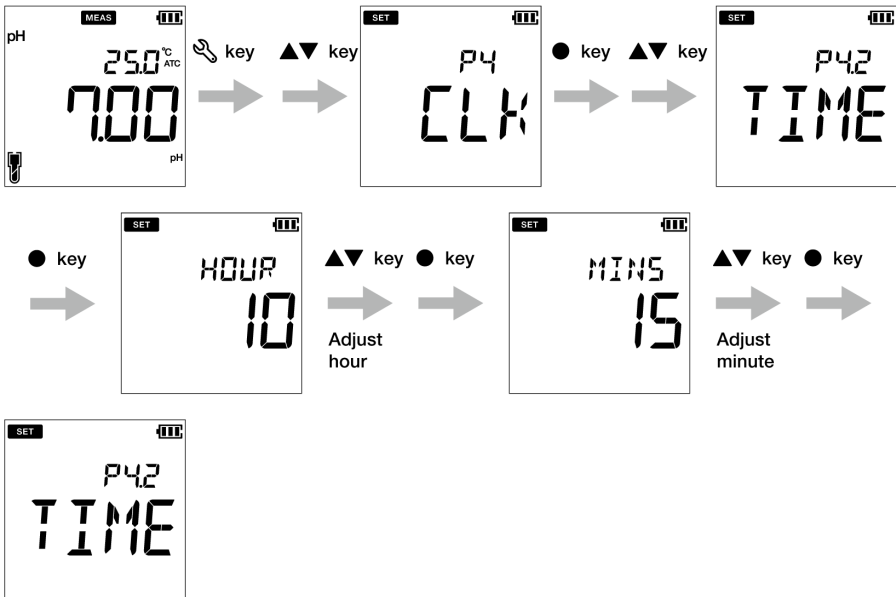

DO mode

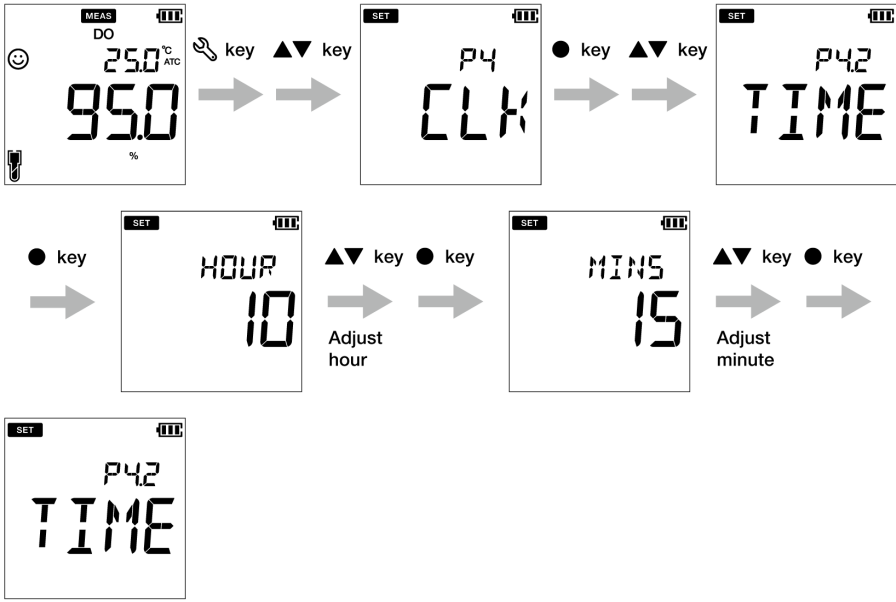

■ Maintenance and storage

This section describes maintenance of LAQUA PD200 handheld meter, pH, ORP and DO electrodes used with the meter.

● Maintenance contract

Please contact your dealer for the product maintenance contract.

● Maintenance and storage of the instrument

● How to clean the instrument

- If the instrument is dirty, wipe it gently with a soft dry cloth. If it is difficult to remove the dirt, wipe it gently with a cloth moistened with alcohol.
- The instrument is made of solvent resistant materials but is not resistant to all chemicals. Do not dip the instrument in strong acid or alkali solution, or wipe it with such solutions.
- Do not wipe the instrument with polishing powder or other abrasive compound.

● Environmental conditions for storage

- Temperature: 0 °C to 45 °C
- Humidity: under 80% relative humidity and free from condensation

● Avoid the following conditions:

- Dusty place
- Strong vibration
- Direct sunlight
- Corrosive gas environment
- Close to an air-conditioner
- Direct wind

● Maintenance and storage of electrodes

This section describes an overview of the procedures for maintenance and storage of pH, ORP and DO electrodes.

● How to clean the pH and ORP electrodes

Always clean the electrode with deionized water after every measurement. When the response is slow or residue from the sample adheres to the electrode, use the appropriate method below to clean the electrode, and then clean again with deionized water.

For pH electrode

| Type of dirt | Cleaning solution |
|---------------------|---|
| General | Diluted neutral cleaning solution |
| Oil | Alcohol, or diluted neutral cleaning solution |
| Inorganic substance | 1 mol/L HCl or electrode cleaning solution |
| Protein | Cleaning solution including protein-removing enzyme |
| Alkali | Dip in 1 mol/L HCl or electrode cleaning solution for 1h to 2 h |

For ORP electrode

| Type of dirt | Cleaning solution |
|---------------------|---|
| General | Dilute neutral cleaning solution (General dish washing liquid works reasonably well.) |
| Oil | |
| Inorganic substance | Immerse dilute nitric acid (1:1 nitric acid) |

● How to clean the membrane of DO electrode

The membrane of DO electrode is extremely thin. Take care, not to tear the membrane when cleaning. Clean the membrane with deionized water and wipe it with a soft cloth, take care not to damage it.

Note

When using a neutral cleaning solution to clean the DO electrode, keep the neutral cleaning solution away from the membrane in order to prevent deterioration of the membrane.

● Daily storage of the pH and ORP electrodes

If the electrode becomes dry, the response will be slow. Store in a moist atmosphere. Follow the steps below to properly store the electrodes even when the electrodes will not be used for a long period.

1. Wash the electrode well with pure water (or deionized water) to remove sample completely, and close the internal solution filler port.
2. Wash the inside of the protective cap with pure water (or deionized water), then add enough pure water (or deionized water) to soak the sponge.
3. Attach the protective cap.

● Daily storage of the DO electrode

Follow the steps below to store the electrode correctly.

9552-20D, 9552-50D

4. Clean the DO electrode well with deionized water.
5. Store electrode in carry case in a dry condition.

● When the DO electrode will not be used for a long time

Follow the steps below to store the electrode correctly.

9552-20D, 9552-50D

1. Clean the DO electrode well with tap water, then dry it with cotton gauze.
2. Remove the DO tip from the DO electrode.
3. Attach the socket on the DO tip, then store it in a cool, dark location.

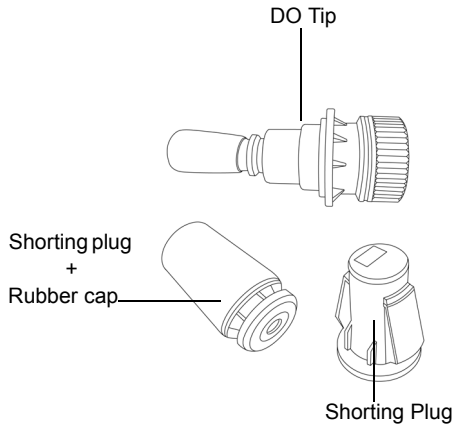



■ Error messages and trouble shooting

● Error message

This section describes the causes of typical errors and the actions to be taken to resolve respective errors.

If ERR is displayed while you are using the instrument, check the error, its cause and action to be taken in the error list below:

| Meter display | ERR description | Cause of error and How to solve the problem |
|---|---|---|
| BATT LOW | Low battery | Battery power is low. Please replace with new batteries. |
| OFFS ERR | Offset voltage error | Electrode is dirty or reference junction is clogged. Clean the electrode. |
| SLPE ERR | Slope error | Electrode sensitivity is low. Please clean and recalibrate with fresh standard solution. If the problem persists, replace the electrode with new one. |
| BUFF ERR | Can not auto recognize standard solution | The instrument cannot identify the standard solution. Check the calibration solution and use fresh one if required. |
|  | Calibration interval alarm error | Exceeds the calibration interval setup. Calibrate the meter. |
| MEM FULL | Memory data full | The number of the data saved has exceeded the specified number of items. Print or transfer the data. Or, clear stored data. |
|  | If user selects the enter key before stable in calibration mode | ● key is pressed before the calibration value has stabilized. Wait for the value to be stable and then press the ● key. |

● **Trouble shooting**

This section describes causes and actions to take for problems that customers frequently ask.

The indicated value fluctuates

< **Problem with the electrode** >

| Cause | How to solve problem |
|---|------------------------|
| The electrode is dirty. | Clean the electrode. |
| The electrode is broken. | Replace the electrode. |
| The level of reference electrolyte gel. | Replace the electrode. |

< **Problem with the instrument** >

| Cause | How to solve problem |
|---|---|
| There is a motor or other device causing electrical interference. | Measure at a place where no influence from induction is given. Ground all AC-powered equipment. |
| The electrode is not connected correctly. | Connect the electrode properly. |

< **Problem with the sample** >

| Cause | How to solve problem |
|--|---|
| Electrode is not immersed enough to cover liquid junction. | The electrode must be immersed up to the liquid junction. As a guide, immerse to at least 3 cm from the tip of the electrode. |
| The stability of electrode is affected by the sample solution. | It is important to select an electrode that is appropriate for the sample. Consult your dealer. To confirm an electrode that is appropriate for the sample, check the pH electrode selection guide in our catalogue, or refer to our website. |

The response is slow

| Cause | How to solve problem |
|---|---|
| The electrode is dirty. | Clean the electrode. |
| The electrode is broken. | Replace the electrode. |
| The response of electrode is affected by the sample solution. | It is important to select an electrode that is appropriate for the sample. Consult your dealer. To confirm an electrode that is appropriate for the sample, check the pH electrode selection guide in our catalogue, or refer to our website. |

The indicated value does not change

| Cause | How to solve problem |
|---|---|
| The electrode is broken. | Replace the electrode. |
| The electrode is not connected correctly. | Connect the electrode correctly. |
| Keys are locked. | Turn OFF the power, remove the batteries, and then turn ON the power again. |
| The instrument is in HOLD state. | Cancel the HOLD state. |
| Instrument defect | Consult your dealer. |

The measured value is out of the measurement range

When the measured value is below the display range, “Ur” appears. When the measured value is over the display range, “Or” appears.

| Cause | How to solve problem |
|--|--|
| Sample is out of the measurement range. | Use a sample within the measurement range. |
| Electrode is not immersed enough to cover liquid junction. | The electrode must be immersed up to the liquid junction. As a guide, immerse to at least 3 cm from the tip of the electrode. |
| The electrode cable is broken. | Replace the electrode. |
| Calibration is not performed or performed incorrectly. | Perform calibration correctly. |
| Instrument defect | Check as explained below. |

● How to check for instrument defect (pH mode)

Short the metal part of the outer tube to the center pin of the electrode connector of the corresponding channel of the instrument. If “Ur” or “Or” appears in this condition, consult your dealer.

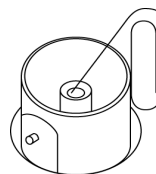

Repeatability of the measured value is poor

| Cause | How to solve problem |
|---|---|
| Effect of the sample solution | Repeatability becomes poor when the pH or DO of the sample changes over time. |
| The electrode is dirty. | Clean the electrode. |
| The electrode is broken. | Replace the electrode. |
| The internal solution of the electrode is partially depleted or contaminated. | Replace the electrode. |

Nothing appears when the power is turned ON

| Cause | How to solve problem |
|--------------------------------------|---|
| Power is not supplied. | Insert batteries. |
| Battery polarity (+, -) is reversed. | Insert the batteries with the polarity (+, -) correctly oriented. |
| Battery life is low. | Replace the batteries. |
| Instrument defect | Consult your dealer. |

Swelling of keypad

| Cause | How to solve problem |
|--|--|
| Using the instrument at high elevation or other location where the air pressure is different from sea level. | To eliminate the pressure difference between the inside and outside of the instrument, briefly open and then close the serial connector and battery cover. After opening, correctly close the cover to maintain dust and water proofing. |
| Instrument defect | Consult your dealer. |

Part of the display is missing

| Cause | How to solve problem |
|-------------------|---|
| Instrument defect | Check the display by switching ON the instrument when all the LCD segments are lit. |

■ **Appendix**

● **Appendix 1**

This section describes technical information and option for LAQUA PD200 handheld meters.

The pH vs. temperature values for the various standards are listed below:

< USA >

| Temp. (°C) | pH 1.68 | pH 4.01 | pH 7.00 | pH 10.01 | pH 12.46 |
|------------|---------|---------|---------|----------|----------|
| 0 | 1.67 | 4.01 | 7.12 | 10.32 | |
| 5 | 1.67 | 4.01 | 7.09 | 10.25 | 13.25 |
| 10 | 1.67 | 4.00 | 7.06 | 10.18 | 13.03 |
| 15 | 1.67 | 4.00 | 7.04 | 10.12 | |
| 20 | 1.68 | 4.00 | 7.02 | 10.06 | 12.64 |
| 25 | 1.68 | 4.01 | 7.000 | 10.01 | 12.46 |
| 30 | 1.69 | 4.01 | 6.98 | 9.97 | 12.29 |
| 35 | 1.69 | 4.02 | 6.98 | 9.93 | |
| 40 | 1.70 | 4.03 | 6.97 | 9.89 | 11.99 |
| 45 | 1.70 | 4.04 | 6.97 | 9.86 | |
| 50 | 1.71 | 4.06 | 6.97 | 9.83 | 11.73 |
| 55 | 1.72 | 4.08 | 6.97 | 9.81 | |

< NIST >

| Temp. (°C) | pH 1.68 | pH 4.01 | pH 6.86 | pH 9.18 | pH 12.46 |
|------------|---------|---------|---------|---------|----------|
| 0 | 1.67 | 4.00 | 6.98 | 9.46 | |
| 5 | 1.67 | 4.00 | 6.95 | 9.39 | 13.25 |
| 10 | 1.67 | 4.00 | 6.92 | 9.33 | 13.03 |
| 15 | 1.67 | 4.00 | 6.90 | 9.27 | |
| 20 | 1.68 | 4.00 | 6.88 | 9.22 | 12.64 |
| 25 | 1.68 | 4.01 | 6.86 | 9.18 | 12.46 |
| 30 | 1.69 | 4.01 | 6.85 | 9.14 | 12.29 |
| 35 | 1.69 | 4.02 | 6.84 | 9.10 | |
| 40 | 1.70 | 4.03 | 6.84 | 9.04 | 11.99 |
| 45 | 1.70 | 4.04 | 6.83 | 9.04 | |
| 50 | 1.71 | 4.06 | 6.83 | 9.01 | 11.73 |
| 55 | 1.72 | 4.08 | 6.83 | 8.99 | |

< DIN >

| Temp. (°C) | pH 1.09 | pH 3.06 | pH 4.65 | pH 9.23 | pH 12.75 |
|------------|---------|---------|---------|---------|----------|
| 0 | 1.08 | 3.10 | 4.67 | 9.48 | 13.37 |
| 5 | 1.09 | 3.10 | 4.66 | 9.43 | 13.37 |
| 10 | 1.09 | 3.10 | 4.66 | 9.37 | 13.37 |
| 15 | 1.09 | 3.08 | 4.65 | 9.32 | 13.17 |
| 20 | 1.09 | 3.07 | 4.65 | 9.27 | 12.96 |
| 25 | 1.09 | 3.06 | 4.65 | 9.23 | 12.75 |
| 30 | 1.10 | 3.05 | 4.65 | 9.18 | 12.61 |
| 35 | 1.10 | 3.04 | 4.65 | 9.13 | 12.45 |
| 40 | 1.10 | 3.04 | 4.66 | 9.09 | 12.29 |
| 45 | 1.11 | 3.04 | 4.67 | 9.04 | 12.14 |
| 50 | 1.11 | 3.04 | 4.68 | 9.00 | 11.98 |
| 55 | 1.11 | 3.04 | 4.69 | 8.96 | 11.84 |

● Saturated DO levels in water at various temperatures

ISO17289 (JIS K0102)

| Temp. (°C) | Saturated DO (mg/L) | Temp. (°C) | Saturated DO (mg/L) | Temp. (°C) | Saturated DO (mg/L) | Temp. (°C) | Saturated DO (mg/L) |
|------------|---------------------|------------|---------------------|------------|---------------------|------------|---------------------|
| 1 | 14.22 | 11 | 11.03 | 21 | 8.92 | 31 | 7.43 |
| 2 | 13.83 | 12 | 10.78 | 22 | 8.74 | 32 | 7.31 |
| 3 | 13.46 | 13 | 10.54 | 23 | 8.58 | 33 | 7.18 |
| 4 | 13.11 | 14 | 10.31 | 24 | 8.42 | 34 | 7.07 |
| 5 | 12.77 | 15 | 10.08 | 25 | 8.26 | 35 | 6.95 |
| 6 | 12.45 | 16 | 9.87 | 26 | 8.11 | 36 | 6.84 |
| 7 | 12.14 | 17 | 9.67 | 27 | 7.97 | 37 | 6.73 |
| 8 | 11.84 | 18 | 9.47 | 28 | 7.83 | 38 | 6.62 |
| 9 | 11.56 | 19 | 9.28 | 29 | 7.69 | 39 | 6.52 |
| 10 | 11.29 | 20 | 9.09 | 30 | 7.56 | 40 | 6.41 |

• Appendix 2**Printer format - Measurement****pH**

| | |
|------------------|----------------|
| Meter Model | : HORIBA PD220 |
| Serial Number | : 123456789 |
| SW Revision | : 1.00 |
| Date | : 20 Aug 2018 |
| Time | : 10:10:28 |
| Mode | : pH |
| pH | : 7.00 pH |
| mV | : 0.0 mV |
| Temperature | : 25.0 C (MAN) |
| Electrode Status | : Excellent |
| User Name | : |
| Signature | : |

mV

| | |
|---------------|----------------|
| Meter Model | : HORIBA PD220 |
| Serial Number | : 123456789 |
| SW Revision | : 1.00 |
| Date | : 20 Aug 2018 |
| Time | : 10:10:28 |
| Mode | : mV |
| mV | : 0.0 mV |
| Temperature | : 25.0 C (MAN) |
| User Name | : |
| Signature | : |

Relative mV

| | |
|---------------|----------------|
| Meter Model | : HORIBA PD220 |
| Serial Number | : 123456789 |
| SW Revision | : 1.00 |
| Date | : 20 Aug 2018 |
| Time | : 10:10:28 |
| Mode | : R. mV |
| R. mV | : 3.0 mV |
| Offset | : -3.0 mV |
| Temperature | : 25.0 C (MAN) |
| User Name | : |
| Signature | : |

DO - mg/L

| | |
|------------------|----------------|
| Meter Model | : HORIBA PD220 |
| Serial Number | : 123456789 |
| SW Revision | : 1.00 |
| Date | : 20 Aug 2018 |
| Time | : 10:10:28 |
| Mode | : DO |
| DO | : 7.26 mg/L |
| Temperature | : 25.0 C (MAN) |
| Electrode Status | : Excellent |
| User Name | : |
| Signature | : |

Do - %

| | |
|------------------|----------------|
| Meter Model | : HORIBA PD220 |
| Serial Number | : 123456789 |
| SW Revision | : 1.00 |
| Date | : 20 Aug 2018 |
| Time | : 10:10:28 |
| Mode | : Do |
| Do | : 100.0 % |
| Temperature | : 25.0 C (MAN) |
| Electrode Status | : Excellent |
| User Name | : |
| Signature | : |

Printer format - Data log

| | |
|------------------|----------------|
| Meter Model | : HORIBA PD220 |
| Serial Number | : 123456789 |
| SW Revision | : 1.00 |
| User Name | : |
| Signature | : |
| Logged Data | |
| Location | : 2 |
| Date | : 10 Aug 2018 |
| Time | : 10:10:28 |
| Mode | : pH |
| pH | : 7.00 pH |
| mV | : 0.0 mV |
| Temperature | : 25.0 C (MAN) |
| Electrode Status | : Excellent |
| Location | : 1 |
| Date | : 10 Aug 2018 |
| Time | : 10:09:28 |
| Mode | : mV |
| mV | : 178.0 mV |
| Temperature | : 25.0 C (MAN) |

Printer format - Calibration

PH

| | |
|------------------|---------------------|
| Meter Model | : HORIBA PD220 |
| Serial Number | : 123456789 |
| SW Revision | : 1.00 |
| Date | : 20 Aug 2018 |
| Time | : 10:10:28 |
| Calibration data | |
| Cal Date | : 20 Jun 2018 |
| Cal Time | : 10:10:10 |
| Cal Points | : 4.01, 7.00, 10.01 |
| Offset | : 0.0 mV |
| Avg Slope | : 98.2 % |
| Cal Temp. | : 25.0 C (ATC) |
| Electrode Status | : Excellent |
| User Name | : |
| Signature | : |

DO (%)

| | |
|------------------|------------------|
| Meter Model | : HORIBA PD220 |
| Serial Number | : 123456789 |
| SW Revision | : 1.00 |
| Date | : 20 Aug 2018 |
| Time | : 10:10:28 |
| Cal Points | : 100.0 %, 0.0 % |
| Span. Coef | : 1.23 |
| Zero. Coef | : 0.12 |
| Cal Temp. | : 25.0 C (ATC) |
| Electrode Status | : Excellent |
| User Name | : |
| Signature | : |

DO (mg/L)

| | |
|------------------|-----------------------|
| Meter Model | : HORIBA PD220 |
| Serial Number | : 123456789 |
| SW Revision | : 1.00 |
| Date | : 20 Aug 2018 |
| Time | : 10:10:28 |
| Cal Points | : 8.26 mg/L, 0.0 mg/L |
| Span. Coef | : 1.23 |
| Zero. Coef | : 0.12 |
| Cal Temp. | : 25.0 C (ATC) |
| Electrode Status | : Excellent |
| User Name | : |
| Signature | : |

* Meter kit with NIST pH buffers is available upon request. Add 'N' suffix to order code.

*1 Via PC (USB) cable PN 3200779639

*2 Via Printer (RS232) cable PN 3200779638

● Appendix 3

| Model | PD210 | PD220 |
|-------------------------------------|---|-------|
| | pH/ORP/DO/Temp (°C/°F) | |
| pH Range | -2.00 to 16.00 pH | |
| Resolution | 0.01 pH | |
| Accuracy | ±0.01 pH | |
| Calibration Points | USA & NIST (Up to 5), DIN (Up to 6) | |
| pH Buffer Groups | USA, NIST, DIN | |
| ORP Range | ±2000 mV | |
| Resolution | 0.1 mV (< ±1000 mV), 1 mV (≥ ±1000mV) | |
| Accuracy | ±0.3 mV (< ±1000 mV) or 0.3% of reading (≥ ±1000mV) | |
| Calibration Option | Yes | |
| Dissolved Oxygen (DO) Range | 0.0 to 20.00 mg/L 0.0 to 200.0% | |
| Resolution | 0.01 mg/L, 0.1% | |
| Accuracy | ±0.1 mg/L | |
| Salinity Compensation | 0.0 to 40.0 ppt | |
| Barometric Pressure Compensation | Yes | |
| DO Probe Type | Galvanic integrated with temperature sensor | |
| Calibration Points | Up to 2 | |
| Temperature Range | -30.0 to 130.0 °C / -22.0 to 266.0 °F | |
| Resolution | 0.1 °C / °F | |
| Accuracy | ± 0.5 °C / ± 0.9 °F | |
| Calibration Option | Yes | |
| Memory | 500 | 1000 |
| Auto Data Log | ● | ● |
| Real-time Clock | - | ● |
| Date & Time Stamp | - | ● |
| Auto Hold / Auto Stable / Real Time | ● | ● |
| Offset & Average Slope Display | ● | ● |
| Calibration Alarm (1 to 90 days) | ● | ● |
| Auto Shut-Off (1 to 30 mins.) | ● | ● |
| Electrode Status | ● | ● |
| Diagnostic Messages | ● | ● |
| Software Upgrade*1 | ● | ● |

| | | |
|-------------------------------------|---|---|
| PC Communication* ¹ | - | ● |
| Printer Communication* ² | - | ● |
| Meter Inputs | BNC, phono | |
| Display | Custom LCD with backlight | |
| Housing | IP67, shock & scratch resistant, non-slip | |
| Power Requirement | 2 × AA batteries | |
| Battery Life | > 500 hours | |
| Dimensions | 160 (L) × 80 (W) × 40.60 (H) mm | |
| Weight | Approx. 260 g (with batteries) / 216 g (without batteries) | |

* Meter kit with NIST pH buffers is available upon request. Add 'N' suffix to order code.

*1 Via PC (USB) cable PN 3200779639

*2 Via Printer (RS232) cable PN 3200779638

HORIBAAdvanced Techno

31, Miyanonishi-cho, Kisshoin Minami-ku, Kyoto 601-8306, Japan
<http://www.horiba-adt.jp>

For any questions regarding this product, please contact your local agency, or inquire from the following website.
http://global.horiba.com/contact_e/index.htm

