

JUMO LOGOSCREEN 700

Highly scalable paperless recorder

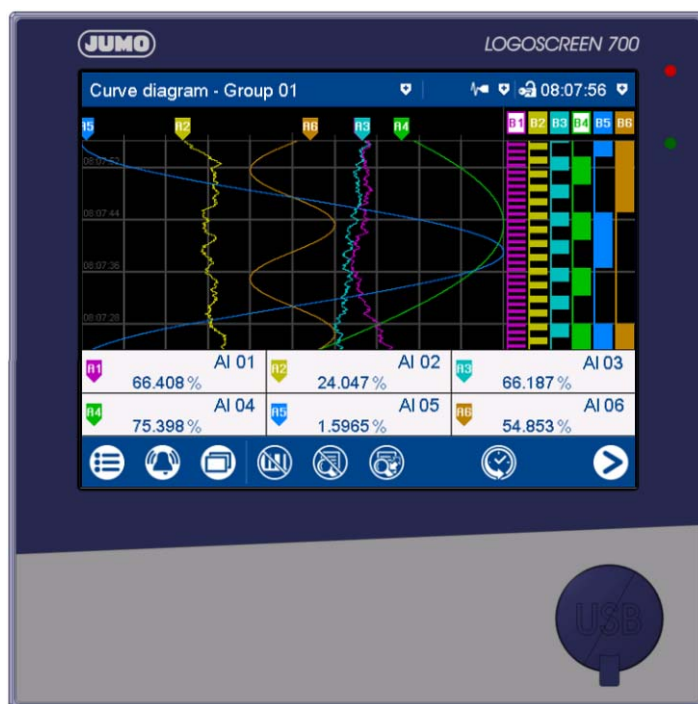

Brief Instructions



70653000T97Z001K000

V1.00/EN/00710320

1	Introduction	7
1.1	Safety information	7
1.2	Intended use	8
1.3	Qualification of personnel	8
1.4	Acceptance of goods, storage, and transport	8
1.4.1	Checking the delivery	8
1.4.2	Important information about storage and transport	8
1.4.3	Returning goods	8
1.4.4	Disposal	9
1.5	Identifying the device version	10
1.5.1	Nameplate	10
1.5.2	Order details	11
1.5.3	Scope of delivery	12
1.5.4	Accessories	12
1.6	Content of the technical documentation	13
1.6.1	Device documentation in printed form	13
1.6.2	Device documentation in the form of PDF files	13
1.6.3	Documentation for optional software	14
1.7	Device version	14
2	Description	15
2.1	Brief description	15
2.2	Block diagram	15
2.3	Display and control elements	16
2.4	Connection elements	16
3	Mounting	17
3.1	General information on mounting	17
3.2	Dimensions	18
3.3	Panel mounting	19
3.4	Handling the front of the device	19
3.5	Terminal cover (accessories)	20
3.6	Universal carrying case, compact (extra code 970)	21
4	Electrical connection	23
4.1	Installation notes	23
4.2	Galvanic isolation	24
4.3	Connection elements	25
4.4	Connection diagram	27
4.4.1	Analog inputs	27
4.4.2	Digital inputs	29
4.4.3	Analog outputs	31

Contents

4.4.4	Digital inputs/outputs	32
4.4.5	Relays	34
4.4.6	RS232/RS485 interface	35
4.4.7	Ethernet/PROFINET	35
4.4.8	Voltage supply	35
5	Operation	37
5.1	Operating concept	37
5.1.1	Touchscreen	37
5.1.2	LED displays	39
5.2	Main menu	40
5.2.1	Logon	40
5.2.2	Configuration	41
5.2.3	Parameterization	41
5.2.4	Device information	41
5.2.5	Audit trail list	41
5.2.6	Service	42
5.2.7	Calibrating the touchscreen	42
5.3	Alarm and event menu	42
5.3.1	Alarm list	43
5.3.2	Event list	44
5.4	Visualization menu (display)	46
5.4.1	Curve diagram	47
5.4.2	Digital diagram	50
5.4.3	Bar graph	51
5.4.4	Text image	52
5.4.5	Report	55
5.4.6	Current batch	57
5.4.7	Completed batch	58
5.4.8	Process screen	60
5.4.9	Counter/integrator	60
5.4.10	Comment text	61
5.5	Text input dialog	62
5.6	Flash manager	65
5.7	Web server	68
5.8	Electronic signature	69
6	Annex	75
6.1	Technical data	75
6.1.1	Analog inputs	75
6.1.2	Digital inputs	78
6.1.3	Analog outputs	78
6.1.4	Digital inputs/outputs	79
6.1.5	Relays	79

Contents

6.1.6	Interfaces	80
6.1.7	Screen.....	81
6.1.8	Electrical data	81
6.1.9	Environmental influences	82
6.1.10	Case	82
6.1.11	Approvals/approval marks	82
6.2	Buffer battery replacement	83
6.3	China RoHS	83
6.4	Barcode.....	84
6.4.1	Batch control.....	84
6.4.2	Texts and process values	87

Contents

1.1 Safety information

General

This manual contains information that must be observed in the interest of your own safety and to avoid material damage. This information is supported by symbols which are used in this manual as indicated.

Please read this manual before starting up the device. Store this manual in a place that is accessible to all users at all times.

If difficulties occur during startup, please do not intervene in any way that could jeopardize your warranty rights!

Warning symbols



WARNING!

This symbol in connection with the signal word indicates that **personal injury** may occur if the respective precautionary measures are not carried out.



CAUTION!

This symbol in connection with the signal word indicates that **material damage or data loss** will occur if the respective precautionary measures are not taken.



CAUTION!

This symbol indicates that **components could be destroyed** by electrostatic discharge (ESD = Electro Static Discharge) if the respective cautionary measures are not taken.

Only use the ESD packages intended for this purpose to return device inserts, assembly groups, or assembly components.



READ THE DOCUMENTATION!

This symbol, which is attached to the device, indicates that the associated **documentation for the device** must be **observed**. This is necessary to identify the nature of the potential hazard, and to take measures to prevent it.

Note symbols



NOTE!

This symbol refers to **important information** about the product, its handling, or additional benefits.



REFERENCE!

This symbol refers to **additional information** in other sections, chapters, or other manuals.



FURTHER INFORMATION!

This symbol is used in tables and indicates that **further information** is provided after the table.



DISPOSAL!

At the end of its service life, the device and any batteries present do not belong in the trash! Please ensure that they are **disposed of** properly and in an **environmentally friendly** manner.

1 Introduction

1.2 Intended use

The device is designed for use in an industrial environment as specified in the technical data. Other uses beyond those defined are not viewed as intended uses.

The device has been manufactured in compliance with applicable standards and directives as well as the applicable safety regulations. Nevertheless, improper use may lead to personal injury or material damage.

To avoid danger, only use the device:

- For the intended use
- When in good order and condition
- When taking the technical documentation provided into account

Risks resulting from the application may arise, e.g. as the result of missing safety provisions or wrong settings, even when the device is used properly and as intended.

1.3 Qualification of personnel

This document contains the necessary information for the intended use of the device to which it relates. It is intended for staff with technical qualifications who have been specially trained and have the appropriate knowledge in the field of automation technology.

The appropriate level of knowledge and the technically fault-free implementation of the safety information and warnings contained in the technical documentation provided are prerequisites for risk-free mounting, installation, and startup as well as for ensuring safety when operating the described modules. Only qualified personnel have the required specialist knowledge to correctly interpret and implement the safety information and warnings contained in this document in specific situations.

1.4 Acceptance of goods, storage, and transport

1.4.1 Checking the delivery

- Ensure that the packaging and its contents are undamaged
- Check the delivery for completeness against the packing slip and order details
- Inform the supplier immediately if there is any damage
- Store damaged parts until clarification is received from the supplier

1.4.2 Important information about storage and transport

- Store the device in a dry, clean environment. Observe the admissible ambient conditions (see "Technical data")
- Protect the device from shock during transport
- The original packaging provides optimum protection for storage and transport

1.4.3 Returning goods

In the event of repair, return the complete device in clean condition.

Use the original packaging to return goods.

Accompanying letter for repair

Please include the completed accompanying letter for repair when returning goods.

Do not forget to state the following:

- Description of the application and
- Description of the error that has occurred

The accompanying letter for repair (Supplementary sheet for product returns) can be downloaded online from the manufacturer's website:

<http://productreturn.jumo.info>

Protection against electrostatic discharge (ESD)

(ESD = electrostatic discharge)

To prevent damage due to ESD, electronic modules or components must be handled, packaged, and stored in an ESD-protected environment. Measures that protect against electrostatic discharge and electric fields are described in DIN EN 61340-5-1 and DIN EN 61340-5-2 "Protection of electronic devices from electrostatic phenomena".

When returning electronic modules or components, please note the following:

- Pack sensitive components only in an environment providing protection against ESD. Workspaces such as this divert electrostatic charges to ground in a controlled manner and prevent static charges due to friction.
- Use only packaging intended specifically for ESD-sensitive assemblies/components. These must consist of conductive plastics.

No liability can be assumed for damage caused by ESD.



CAUTION!

Electrostatic charges occur in non-ESD-protected environments.

Electrostatic discharges can damage modules or components.

- ▶ For transport purposes, use only the ESD packaging provided.
-

1.4.4 Disposal

Disposing of the device



DISPOSAL!

Devices and/or replaced parts should not be placed in the refuse bin at the end of their service life as they consist of materials that can be recycled by specialist recycling plants.

Dispose of the device and the packaging material in a proper and environmentally friendly manner.

For this purpose, observe the country-specific laws and regulations for waste treatment and disposal.

Disposing of the packaging material

The entire packaging material (cardboard packaging, inserts, plastic film, and plastic bags) is fully recyclable.

1 Introduction

1.5 Identifying the device version

1.5.1 Nameplate

The nameplate is affixed to the housing.

Contents

The nameplate contains important information. This includes:

Description	Designation on the nameplate	Example
Device type	Typ	706530/18-1124-25/260
Part no.	TN	00123456
Fabrication number	F-Nr.	0070033801219110006
Voltage supply	-	AC/DC 20 to 30 V, 48 to 63 Hz

Device type (Typ)

Compare the specifications on the nameplate with the order.

Identify the supplied device version using the order details (order code).

Part no. (TN)

The part no. uniquely identifies an article in the catalog. It is important for communication between the customer and the sales department.

Fabrication number (F-Nr.)

The fabrication number indicates, among other things, the date of manufacture (year/week).

Example: F-Nr = 00700338012**1911**0006

The characters in question are digits 12, 13, 14, and 15 (from the left).

The device was therefore produced in the 11th week of 2019.

1.5.2 Order details

(1) Basic type	
706530	Paperless recorder with the following interfaces: 1x Ethernet, 2x USB (1x host, 1x device), 1x RS232/485 interface, as well as a relay (changeover contact)
(2) Basic type extension	
0	Without software package
1	With software package (setup program incl. USB cable, PC Evaluation Software PCA3000, PCA Communication Software PCC; in conjunction with extra code "888" as well with PC Security Manager PCS and PC Audit Trail Manager PCAT software)
(3) Language	
8	Default setting (German/English)
9	Set according to customer specifications
(4) Option 1 (slot 1)^a	
0	Not used
1	Analog/digital: 3 analog and 6 digital inputs, 1 analog output
2	Analog(HI)/digital: 3 analog (HI) ^b and 4 digital inputs, 4 digital inputs/outputs
3	Analog: 6 analog inputs
(5) Option 2 (slot 2)^a	
0	Not used
1	Analog/digital: 3 analog and 6 digital inputs, 1 analog output
2	Analog(HI)/digital: 3 analog (HI) ^b and 4 digital inputs, 4 digital inputs/outputs (individually switchable)
3	Analog: 6 analog inputs
(6) Option 3 (slot 3)^a	
0	Not used
1	Analog/digital: 3 analog and 6 digital inputs, 1 analog output
2	Analog(HI)/digital: 3 analog (HI) ^b and 4 digital inputs, 4 digital inputs/outputs (individually switchable)
3	Analog: 6 analog inputs
(7) Option 4 (slot 4)^a	
0	Not used
4	Digital: 12 digital inputs/outputs (individually switchable)
5	Relay: 6 relay outputs (changeover contact)
(8) Voltage supply	
23	AC 110 to 240 V +10/-15 %, 48 to 63 Hz
25	AC/DC 20 to 30 V, 48 to 63 Hz
(9) Extra code 1	
.	Not used
260	Math and logic module (20 channels each)
221	Structured text (ST code)
(10) Extra code 2	
.	Not used
887	Manipulation detection with digital certificate
888	FDA 21 CFR Part 11 with digital certificate

1 Introduction

(11) Extra code 3	
.	Not used
163	PROFINET IO device interface (incl. Ethernet)
879	AMS2750/CQI-9 ^c
(12) Extra code, housing	
.	Not used
970	Universal carrying case, compact ^d

^a Subsequent expansion is only possible in JUMO Central Services.

^b Analog inputs with increased electric strength (AC 300 V).

^c For the calibration certificate it is necessary to state the channels along with the thermocouple type and the desired measuring points.

^d The extra code is only available in conjunction with voltage supply AC 110 to 240 V. The UL approval does not apply. Use only for personnel with technical qualifications who have been specially trained, and have the relevant knowledge in the field of automation technology! Specifications for ambient temperature and for protection type are to be observed (see technical data)!

Order code (1) (2) (3) (4) (5) (6) (7) (8) (9)^a (10) (11)^a (12)
 / - - / , , ,

Order example 706530 / 1 8 - 1 2 3 4 - 23 / 260 , 887 , 163 , 970

^a Multiple selection at positions 9 and 11 is possible. Specify extra codes one after the other, and separate them with commas.

1.5.3 Scope of delivery

1 paperless recorder in the ordered version
1 quick start guide (brief instructions)
4 mounting elements

1.5.4 Accessories

Description	Part no.
Setup program	00645110
USB cable, A connector to Micro-B connector, length 3 m	00616250
PC Evaluation Software PCA3000	00431882
PCA communication software PCC	00431879
PC software package consisting of: setup program, PC Evaluation Software PCA3000, PCA Communication Software PCC, PC Security Manager PCS, PC Audit Trail Manager PCAT. Please specify all version numbers when placing follow-up orders.	00666817
USB flash drive, 2 GB ^a	00505592
Activation for math and logic module (setup program required)	00716354
Activation for structured text (ST code; setup program required)	00716357
Activation, automatic printout (PCA3000)	00505548
TP-Link TL-WR710N (Wi-Fi router)	00658592
Sealable terminal cover	00712239
Relay (N/O contact) AC 230 V / 3 A for DIN rail	00515872

^a The indicated USB flash drive has been tested and is designed for industrial applications. No liability is assumed for other brands.

1.6 Content of the technical documentation

The documentation for this device is addressed to plant manufacturers and users with appropriate technical expertise; it consists of the following documents.

1.6.1 Device documentation in printed form

70653000T97...

Quick start guide (brief instructions)

A hard copy of the quick start guide is part of the scope of delivery of the device.

The quick start guide describes the steps to take for mounting and electrical connection, as well as the operation of the device. It also contains the order details and a list of technical data.

The quick start guide is an excerpt from the operating manual.

1.6.2 Device documentation in the form of PDF files

The following documents are available for download from the manufacturer's website. They also form part of the scope of delivery of the optional software package.

70653000T10...

Data sheet

The data sheet contains general information about the device, the order details, and the technical data. It forms the basis for selecting the device and making a purchasing decision.

70653000T90...

Operating manual

The operating manual contains full details on mounting, the electrical connection, operation, parameterization, and the configuration of the device. In addition, it contains the order details and a list of technical data.

In the case of the present device, the operating manual also describes the use of the setup program (PC program) with which the device can also be configured.

70653000T92...

Modbus interface description

The interface description provides information on communication with other devices or superordinate systems using the Modbus protocol (Modbus-RTU, Modbus-TCP).

In the case of the present device, the interface description also contains specifications on communication via Ethernet.

70653007T92...

PROFINET interface description

This document explains the use of the PROFINET interface, which can be used to integrate the device into a PROFINET network as an IO device. A GSD file (GSDML) is available for the programming system of the IO controller and describes the features of the device.

70653000T96...

ST editor manual

This document describes the application of the ST editor with which users can create their own applications in the PLC programming language "structured text" (ST) for the device. The document is intended for users with relevant programming knowledge.

The ST editor is a component of the setup program.

1 Introduction

70653000T97...

Quick start guide (brief instructions)

The quick start guide is also available as a PDF file and has the same scope as the printed document.

1.6.3 Documentation for optional software

The following manuals in the form of PDF files are available for download from the manufacturer's website. They also form part of the scope of delivery of the respective software.

B 709701.0 or 70970100T90...

PC evaluation software PCA3000

The operating manual describes the operating principle and the features of the PC evaluation software. The PC evaluation software helps to visualize and evaluate the captured recording data (measurement data, batch data, messages, etc.).

B 709702.0 or 70970200T90...

PCA communication software PCC

The operating manual describes the operating principle and the features of the PCA communication software. The PCA communication software is responsible for the data transfer from a device or system to a PC or to a network.

B 709703.0 or 70970300T90...

PC Security Manager software PCS

The operating manual describes the operating principle and the features of the PC Security Manager software. PCS ensures that only authorized persons can gain access to the system components (device, PC software) and sign electronic signatures in electronic documents. Only system administrators are able to configure the Security Manager.

PCS is only available for devices with extra code 888.

B 709704.0 or 70970400T90...

PC Audit Trail Manager software PCAT

The operating manual describes the operating principle and the features of the PC Audit Trail Manager software. PCAT documents actions performed in the PC software components which lead to modifications of files, user lists (rights files), device lists, etc. The different message types are: "Information", "Warnings", and "Errors". Audit trail recordings cannot be modified.

Device audit trail data is not shown in PCAT, only in PCA3000.

PCAT is only available for devices with extra code 888.

1.7 Device version

The device version of the paperless recorder can be determined through the software version (SW version) of the device. The software version is displayed in the "Device info" menu (Main menu > Device info > Versions > Basic device: SW version).

Structure of the software version number (SW version): 323.xx.yy

323 = basic version, xx = device version, yy = current version

2.1 Brief description

The JUMO LOGOSCREEN 700 paperless recorder is characterized by an intuitive, icon-based operation and visualization concept that makes it easy to operate.

Multiple versions of the JUMO LOGOSCREEN 700 are available for process data recording. The high level of scalability allows for flexible adaptation to various customer requirements: from the device version without measurement input (120 process values via interface) through to different device versions with up to 18 measurement inputs (universal analog inputs), 3 analog outputs, 18 digital inputs, 24 individually switchable digital inputs/outputs, and 7 relay outputs. The version with FDA-compliant data recording fulfills all requirements according to 21 CFR Part 11.

In order to display the recorded data, the JUMO LOGOSCREEN 700 features various visualizations. In addition, the user can use the setup program to create up to 10 separate process screens – with up to 100 objects per process screen – according to his individual requirements. For batch-based processes, there are up to 5 special batch recordings available, which enable the storage of additional, batch-related information. The extra code, "structured text" allows for the creation of individual measurement and recording applications.

2.2 Block diagram

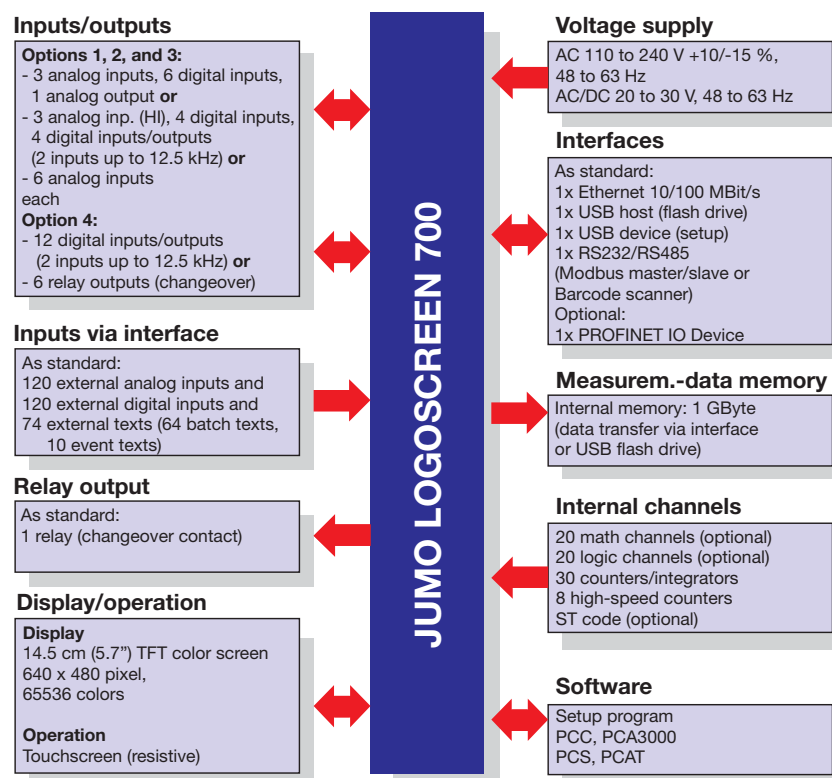

2 Description

2.3 Display and control elements

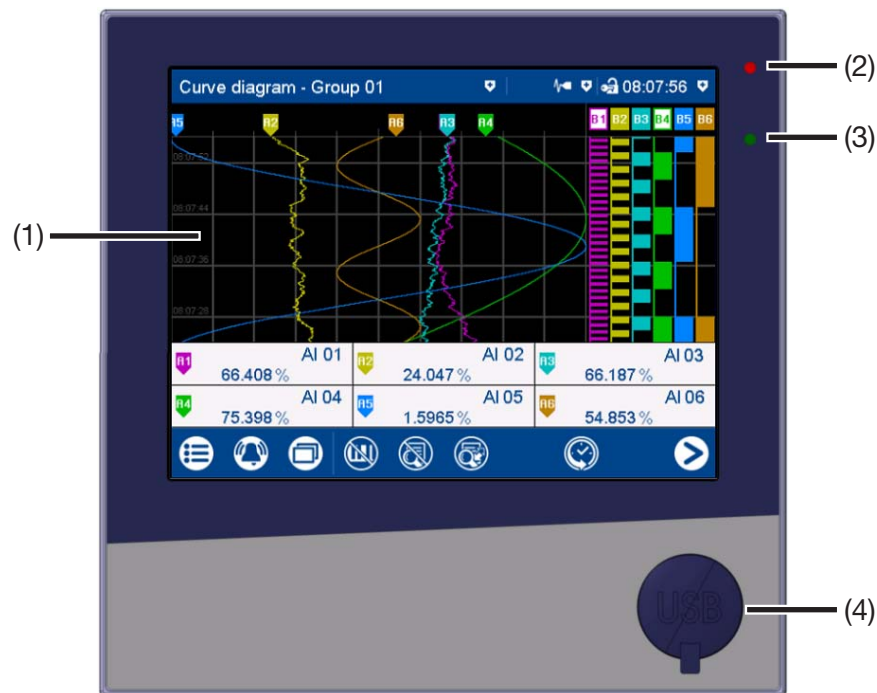

- (1) Touchscreen (TFT color screen)

Technical data:

⇒ chapter 6.1.7 "Screen", page 81

The screen appearance is described in the "Operation" chapter:

⇒ chapter 5.1.1 "Touchscreen", page 37

- (2) Alarm LED

The LED is lit while an alarm is present.

- (3) Power LED

The LED flashes after switching on the device until the startup process is completed. It is then permanently lit.

- (4) USB host interface with cover

To remove the cover, take hold of the lug and pull it out.



CAUTION!

Protection type IP65 (front-side) only with closed USB host interface.

Protection type IP65 is only guaranteed with the available default cover of the USB host interface.

- Only remove the cover to use the interface; then remount the cover immediately (the cover must be flush with the front of the device).

2.4 Connection elements

The connecting elements on the rear of the device and the front-side USB host interface are described in the "Electrical connection" chapter.

⇒ chapter 4.3 "Connection elements", page 25

3.1 General information on mounting



WARNING!

The device is not designed for use in potentially explosive areas.

Explosion hazard.

- ▶ Only deploy the device outside of potentially explosive areas.
-

Mounting site

The device is designed for installation in a panel cut-out. The front of the device and housing have different protection types (see technical data).

Climatic conditions

The ambient temperature and the relative humidity at the mounting site must correspond to the technical data. Aggressive gases and vapors have a negative effect on the operating life of the device. The mounting site must be free from dust, powder, and other suspended solids.

Installation position

Any installation position may be chosen, however the screen view angle must be taken into consideration (see technical data).

Technical data

- ⇒ chapter 6.1 "Technical data", page 75

3 Mounting

3.2 Dimensions

Device

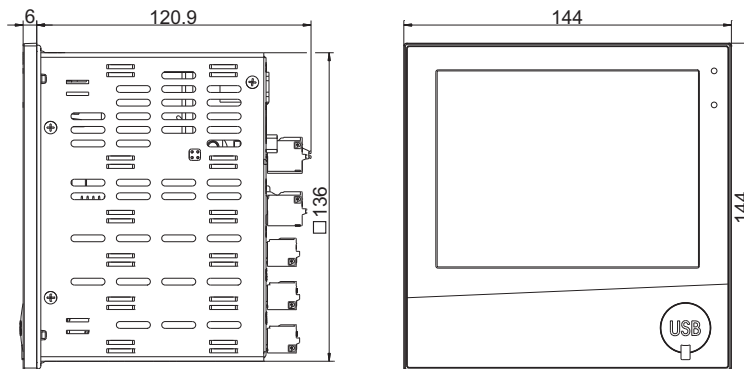

Panel cut-out

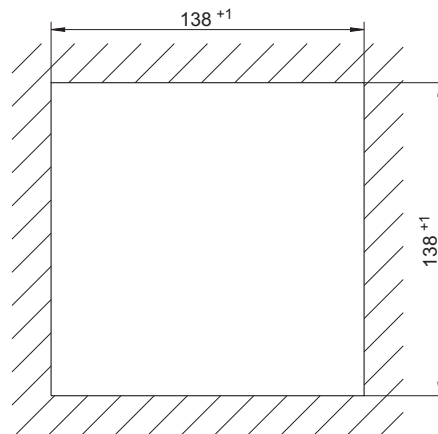

Close mounting

Distance between panel cut-outs	Horizontal	Vertical
Minimum clearance	20 mm	20 mm
Recommended distance (easier mounting of mounting elements)	50 mm	50 mm

Device with terminal cover (accessories)

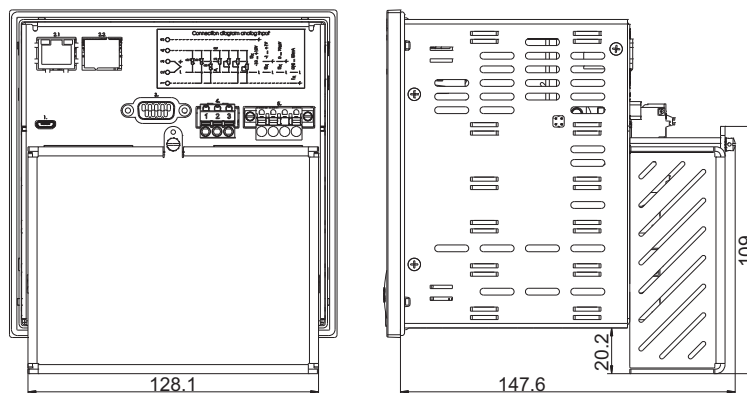

3.3 Panel mounting

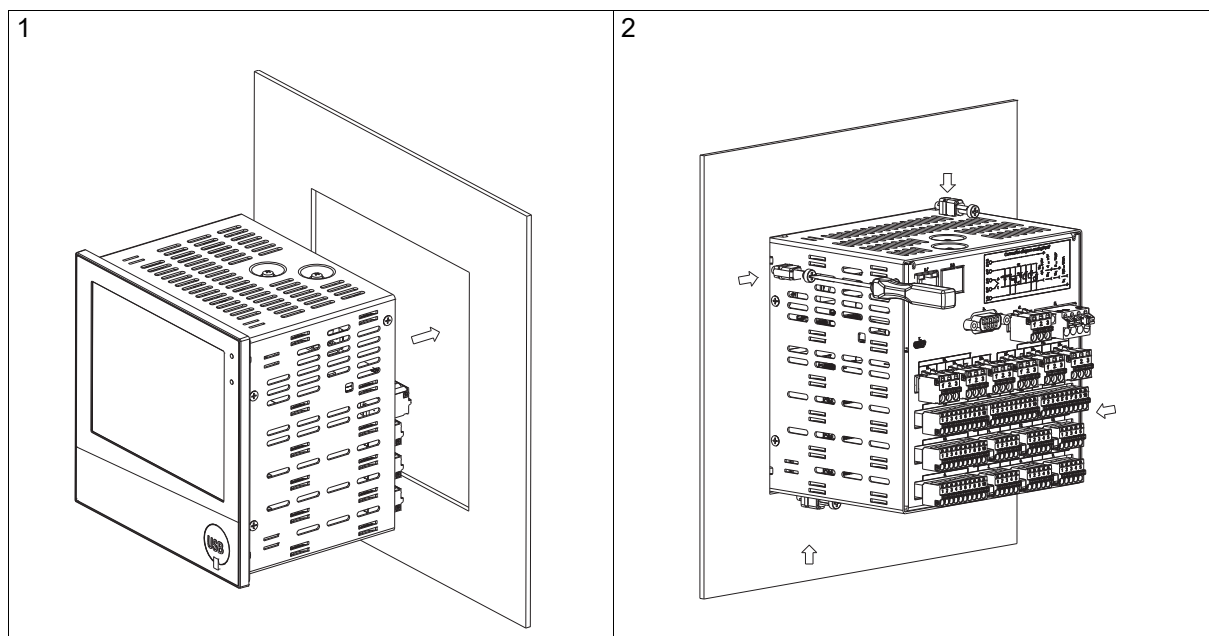

Step	Action
1	Insert the device into the panel cut-out from the front until the seal is flush with the panel.
2	Insert the mounting elements into the recesses of the housing (one element on each corner, see figure) and use a screwdriver to evenly clamp them against the rear side of the panel with a torque of 1.0 Nm.



CAUTION!

The front of the device and housing have different protection types!

The protection type IP65 (front-side) is only guaranteed if the seal is flush and even.

- ▶ The four supplied mounting elements must all be used and must be distributed evenly as shown in the figure.

3.4 Handling the front of the device

Cleaning

The front of the device (front foil) can be cleaned with standard detergents, rinsing and cleaning agents.



CAUTION!

The front of the device is not resistant to aggressive acids and lyes, scouring agents, and cleaning with a pressure cleaner.

Use of these media can cause damage.

- ▶ Only clean the front of the device with suitable agents.

Operation

The screen (resistive touchscreen) can be operated by finger pressure or with a commercially available touchscreen stylus.

3 Mounting



CAUTION!

Sharp or hard objects are not suitable for operating the screen.

They can cause scratches and damage the front foil.

- ▶ Only operate the screen with your finger or with a suitable stylus.

3.5 Terminal cover (accessories)

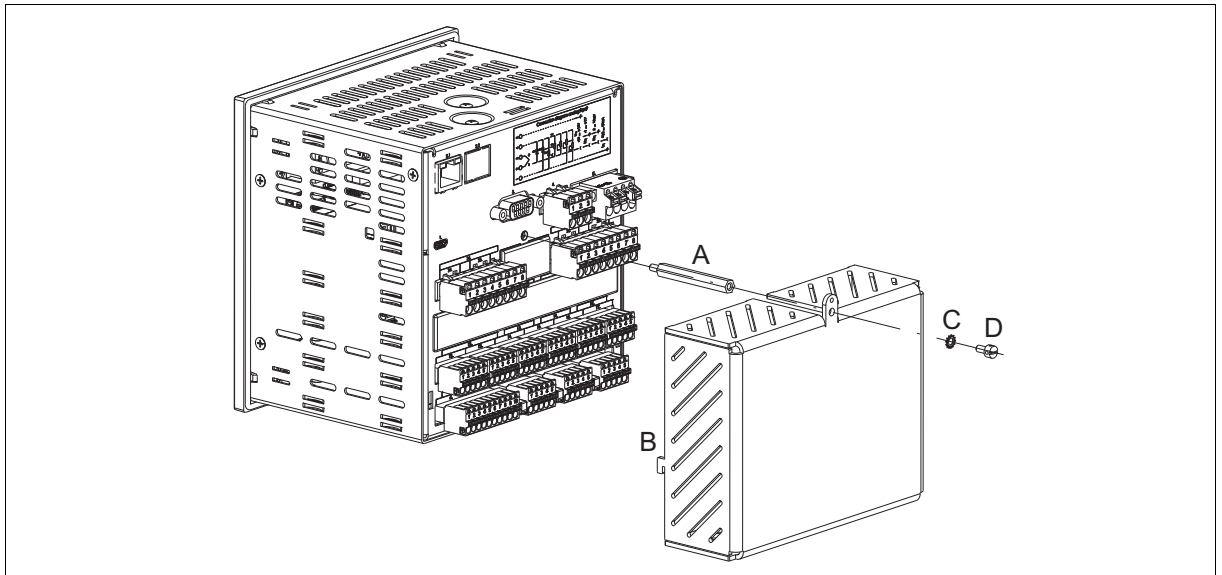

Step	Action
1	Screw the spacer bolt (A) into the rear wall of the device.
2	Attach the terminal cover (B) to the rear wall of the device.
3	Screw the capstan screw (D) with locking washer (C) through the lug of the terminal cover and into the spacer bolt.
4	If necessary attach the seal (not shown here).



NOTE!

Observe the specifications on the maximum admissible conductor cross section when using the terminal cover (see chapter 6.1.8 "Electrical data", page 81).

3.6 Universal carrying case, compact (extra code 970)

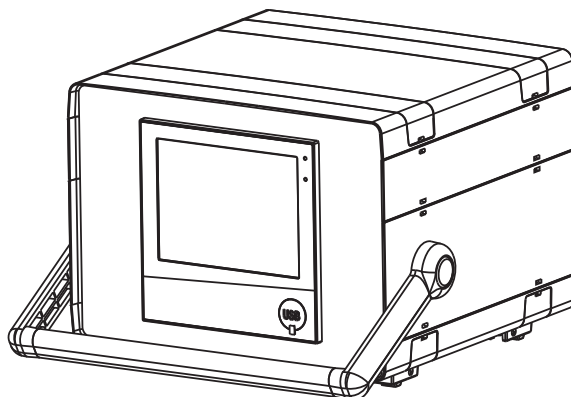

Dimensions

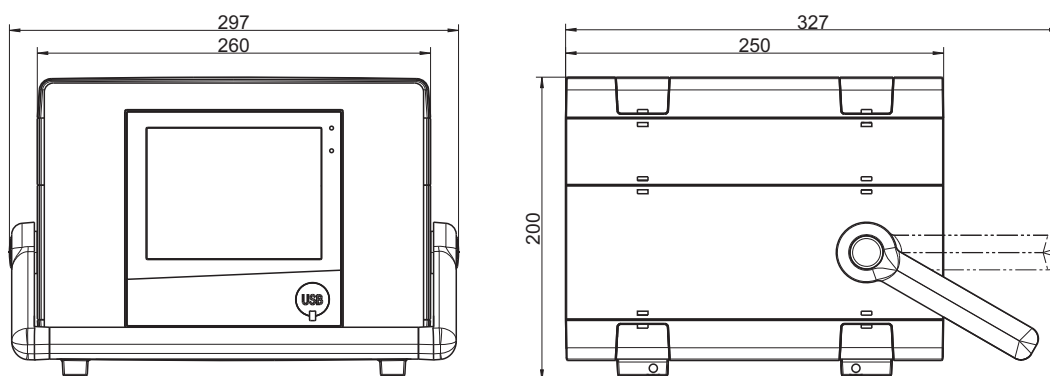

Intended use

The paperless recorder in the carrying case is intended only for use by personnel with technical qualifications who have been specially trained, and have the relevant knowledge in the field of automation technology.

Cleaning

The specifications for cleaning the carrying case are the same as those for cleaning the front of the device.

⇒ chapter 3.4 "Handling the front of the device", page 19

Device fuse

The carrying case is equipped with a replaceable device fuse (micro fuse 5.0 A / 250 V delayed-action, according to DIN EN 60127-2; part no. 65018001). Any faulty fuses must be replaced with the same type of fuse. Disconnect all poles of the carrying case from the mains voltage beforehand (remove the mains plug)!

Mains cable

The removable mains cable (H05VV-F 3G1; 2.5 m long; part no. 00052953) must not be replaced with an insufficiently dimensioned cable.

Differing technical data

Observe the specifications regarding the ambient temperature and protection type of the housing!

⇒ chapter 6.1.9 "Environmental influences", page 82

3 Mounting

⇒ chapter 6.1.10 "Case", page 82

4.1 Installation notes

Requirements for personnel

- Work on the device must only be carried out to the extent described and, like the electrical connection, only by qualified personnel.
- Before plugging and unplugging connecting cables, it must be ensured that the acting person is electrostatically discharged (by touching grounded metallic parts, for example).

Cables, shielding, and grounding

- When selecting the electrical wiring material as well as when installing and connecting the device electrically, comply with the requirements of DIN VDE 0100 "Low-voltage electrical installations" and the applicable country-specific regulations (for example, based on IEC 60364).
- Route input, output, and supply lines separately and not parallel to one another.
- Only use shielded and twisted probe and interface cables. Do not route the lines close to current-carrying components or cables.
- For temperature probes, ground the shielding on one side in the control cabinet.
- Do not perform loophroughs on the grounding cables, but instead route the cables individually to a shared grounding point in the control cabinet; in doing so, ensure that the cables are as short as possible.

Ensure that the potential equalization is correct.

Electrical safety

- The device is intended to be installed in control cabinets or plants. Ensure that the customer's fuse protection does not exceed 20 A. Disconnect the device from the mains voltage on all poles prior to starting service or repair work.
- The relay's load circuit can be operated with a hazardous electrical voltage (e.g. 230 V). De-energize the load circuit during mounting/dismounting and electrical connection.
- To prevent the relay contacts being destroyed in the case of an external short-circuit in the load circuit, the latter must be fuse-protected as per the maximum admissible relay current (see technical data).
- The device is not suitable for installation in potentially explosive areas.
- In addition to a faulty installation, incorrectly set values on the device can also impair the correct function of the downstream process. Therefore, ensure that safety devices independent of the device, e.g., overpressure valves or temperature limiters/monitors, are present and that it is only possible for qualified personnel to define settings. Please observe the corresponding safety regulations in this context.

References to other information

- The electromagnetic compatibility conforms to the standards and regulations cited in the technical data.
- In general, please observe the specifications regarding galvanic isolation.

Technical data

- ⇒ chapter 6.1 "Technical data", page 75

4 Electrical connection

4.2 Galvanic isolation

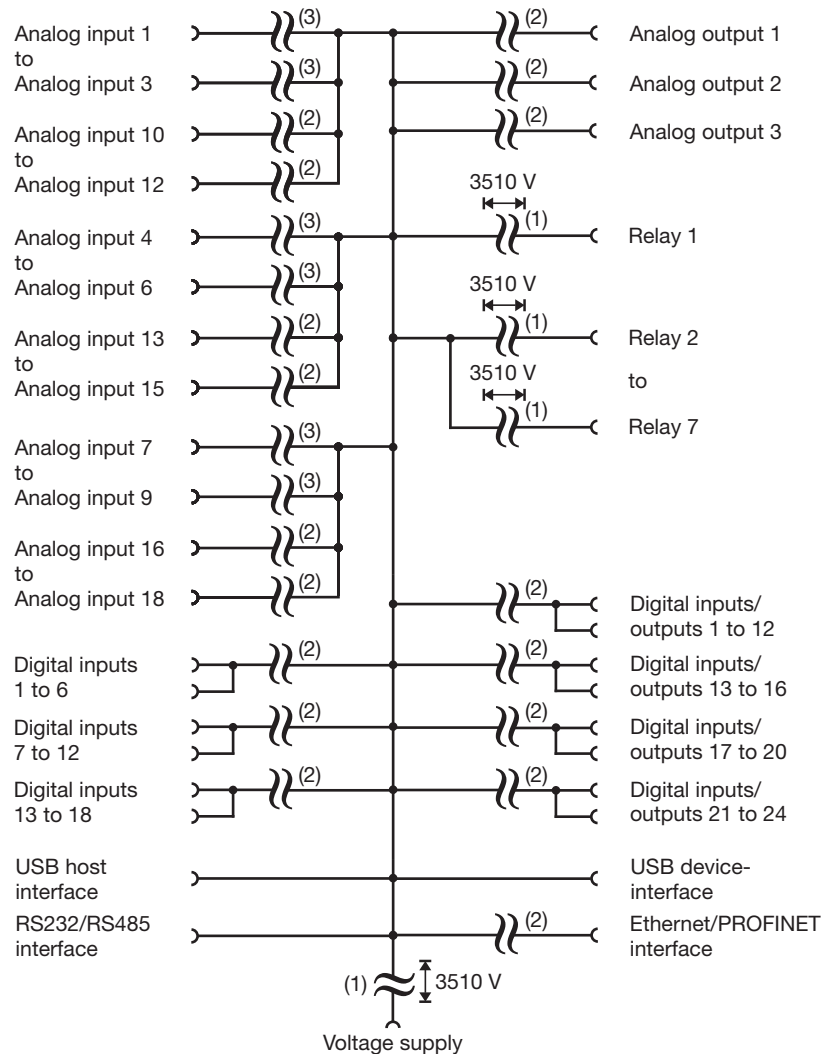

- (1) The voltage specifications correspond to the test voltages (alternating voltage, rms values) according to EN 61010-1:2011-07 for the type test.
- (2) Functional galvanic isolation for connection of SELV or PELV electrical circuits.
- (3) For the options "analog/digital" and "analog": functional galvanic isolation for connection of SELV or PELV electrical circuits.
For the option "analog(HI)/digital": test voltage 3510 V (alternating voltage, rms value) according to EN 61010-1:2011-07 for the type test.

4 Electrical connection

4.3 Connection elements

Front USB host interface (without cover)

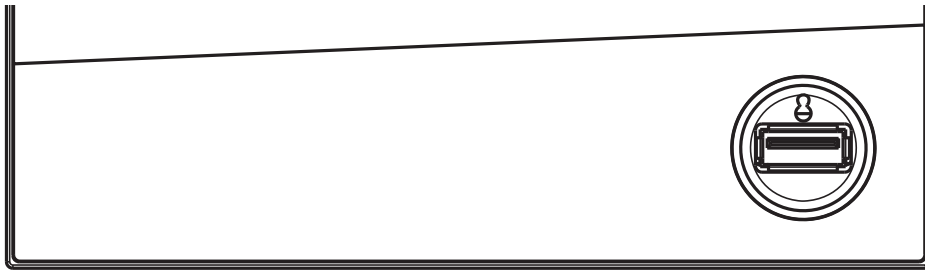

Back connection elements

This graphic shows an example with specific options.

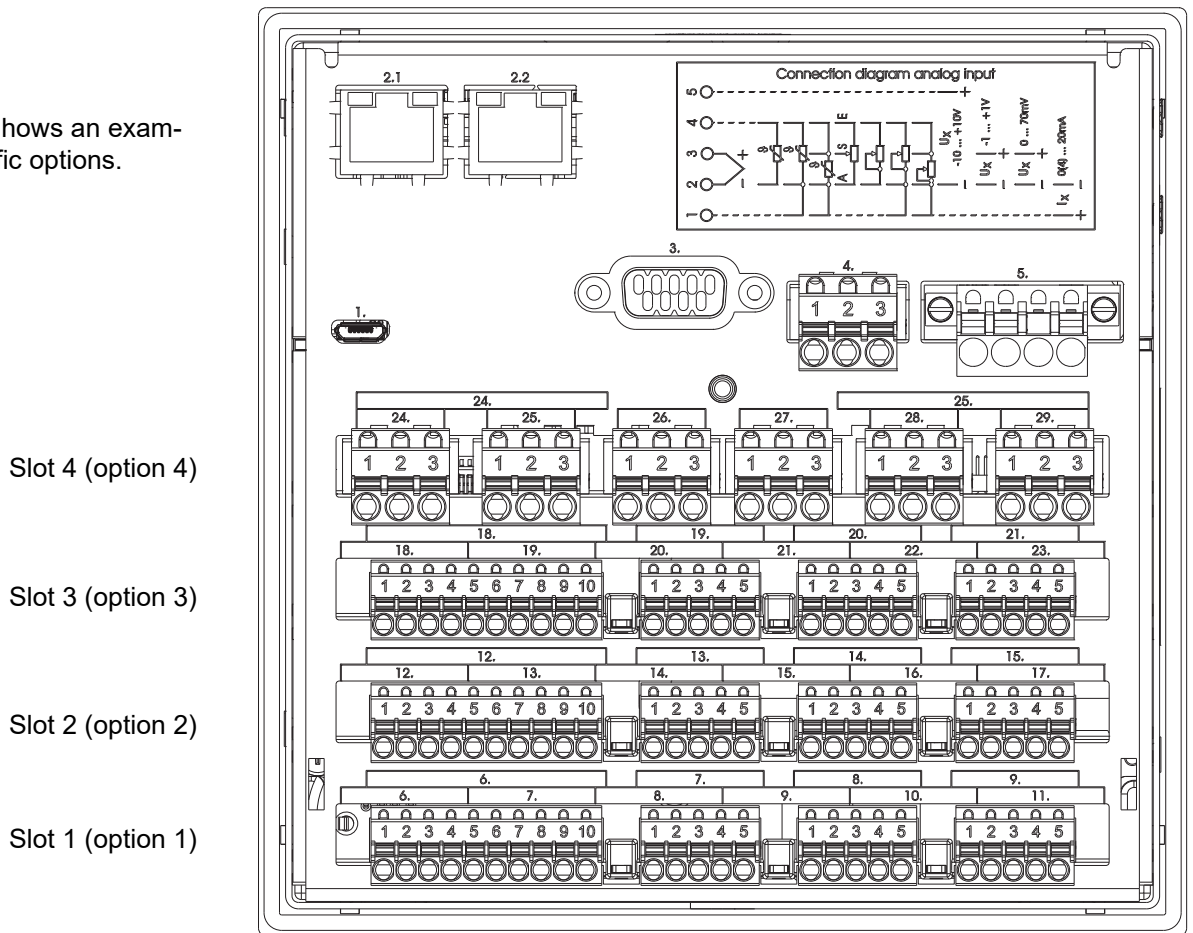

Connection element and assignment	
1.	USB device interface
2.1	Ethernet interface (as a standard feature) or
2.1,	PROFINET interface (including Ethernet; extra
2.2	code)
3.	RS232/RS485 interface

Connection element and assignment	
4.	Relay 1 (changeover contact)
5.	Voltage supply
6. -	Option inputs and outputs (Slot 1 to Slot 4)
29.	

4 Electrical connection



NOTE!

The front-side USB host interface is intended only for connecting a USB flash drive. Any other use is not admissible.



NOTE!

The quality of the USB cable and the USB flash drive affects whether or not the device functions correctly. It is recommended to use the components (accessories) supplied by the manufacturer.



CAUTION!

The device is not suitable for connection to a PoE port (power over Ethernet).

There is the risk of damage to the device.

- ▶ Connect the device to an Ethernet port without PoE.
-



NOTE!

Observe the specifications on the maximum admissible conductor cross section when using the terminal cover (accessories) (see chapter 6.1.8 "Electrical data", page 81).

4 Electrical connection

4.4 Connection diagram

4.4.1 Analog inputs

Measuring probe	Terminals and connection symbol	Connection element.terminal / assignment
Thermocouple		Analog/digital option (order code 1) or analog(HI)/digital option (order code 2):
RTD temperature probe Two-wire circuit		7.1-5 / Analog input 1 8.1-5 / Analog input 2 9.1-5 / Analog input 3 13.1-5 / Analog input 4 14.1-5 / Analog input 5 15.1-5 / Analog input 6
RTD temperature probe Three-wire circuit		19.1-5 / Analog input 7 20.1-5 / Analog input 8 21.1-5 / Analog input 9
RTD temperature probe Four-wire circuit		
Resistance transmitter		
Resistance/potentiometer Two-wire circuit		

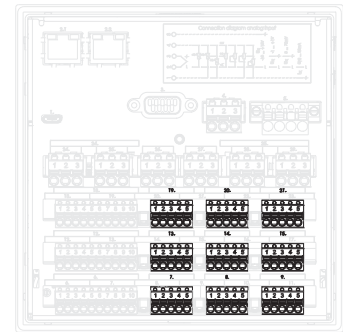

4 Electrical connection

Measuring probe	Terminals and connection symbol	Connection element.terminal / assignment
Resistance/potentiometer Three-wire circuit		Analog option (order code 3): 6.1-5 / Analog input 10 7.1-5 / Analog input 11 8.1-5 / Analog input 12 9.1-5 / Analog input 1 10.1-5 / Analog input 2 11.1-5 / Analog input 3 12.1-5 / Analog input 13 13.1-5 / Analog input 14 14.1-5 / Analog input 15 15.1-5 / Analog input 4 16.1-5 / Analog input 5 17.1-5 / Analog input 6 18.1-5 / Analog input 16 19.1-5 / Analog input 17 20.1-5 / Analog input 18 21.1-5 / Analog input 7 22.1-5 / Analog input 8 23.1-5 / Analog input 9
Resistance/potentiometer Four-wire circuit		
Voltage DC -10(0) to +10 V		
Voltage DC -1(0) to +1 V		
Voltage DC 0 to 70 mV		
Current DC 0(4) to 20 mA		

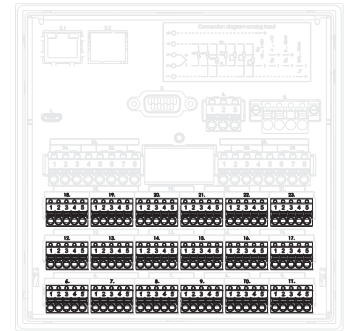

4 Electrical connection

4.4.2 Digital inputs

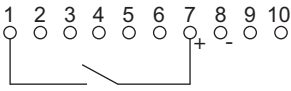
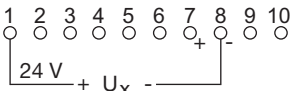
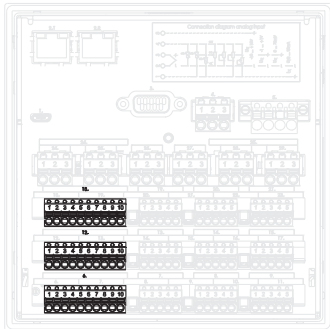
Version	Terminals and connection symbol	Connection element.terminal / assignment
Digital input DC 0/24 V, auxiliary voltage supply DC 24 V	 <p>Example: potential-free contact on digital input 1 and +24 V (auxiliary voltage)</p>  <p>Example: external voltage on digital input 1 and GND</p>	Analog/digital option (order code 1): 6.1 / Digital input 1 6.2 / Digital input 2 6.3 / Digital input 3 6.4 / Digital input 4 6.5 / Digital input 5 6.6 / Digital input 6 6.7 / +24 V 6.8 / GND 12.1 / Digital input 7 12.2 / Digital input 8 12.3 / Digital input 9 12.4 / Digital input 10 12.5 / Digital input 11 12.6 / Digital input 12 12.7 / +24 V 12.8 / GND 18.1 / Digital input 13 18.2 / Digital input 14 18.3 / Digital input 15 18.4 / Digital input 16 18.5 / Digital input 17 18.6 / Digital input 18 18.7 / +24 V 18.8 / GND 

4 Electrical connection

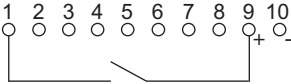
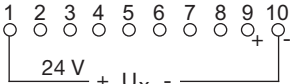
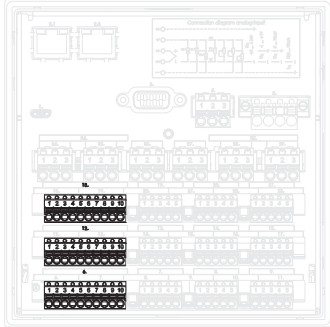
Version	Terminals and connection symbol	Connection element.terminal / assignment
Digital input DC 0/24 V, auxiliary voltage supply DC 24 V	 <p>Example: potential-free contact on digital input 1 and +24 V (auxiliary voltage)</p>  <p>Example: external voltage on digital input 1 and GND</p>	<p>Analog(HI)/digital option (order code 2):</p> <ul style="list-style-type: none"> 6.1 / Digital input 1 6.2 / Digital input 2 6.3 / Digital input 3 6.4 / Digital input 4 6.9 / +24 V 6.10 / GND 12.1 / Digital input 7 12.2 / Digital input 8 12.3 / Digital input 9 12.4 / Digital input 10 12.9 / +24 V 12.10 / GND 18.1 / Digital input 13 18.2 / Digital input 14 18.3 / Digital input 15 18.4 / Digital input 16 18.9 / +24 V 18.10 / GND 

4 Electrical connection

4.4.3 Analog outputs

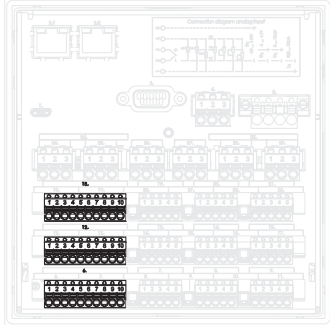
Version	Terminals and connection symbol	Connection element.terminal / assignment
Analog output DC 0 to 10 V or DC 0(4) to 20 mA (configurable)	<div style="display: flex; justify-content: space-around; align-items: center;"> <div style="text-align: center;"> 1 ○ </div> <div style="text-align: center;"> 2 ○ </div> <div style="text-align: center;"> 3 ○ </div> <div style="text-align: center;"> 4 ○ </div> <div style="text-align: center;"> 5 ○ </div> <div style="text-align: center;"> 6 ○ </div> <div style="text-align: center;"> 7 ○ </div> <div style="text-align: center;"> 8 ○ </div> <div style="text-align: center;"> 9 ○ </div> <div style="text-align: center;"> 10 ○ </div> </div> <div style="margin-top: 10px; text-align: center;"> U_x, I_x </div> <div style="margin-top: 10px; text-align: center;"> <div style="display: flex; justify-content: center; gap: 20px;"> + - </div> </div>	<p>Analog/digital option (order code 1):</p> <p>6.9 / Analog output 1 + 6.10 / Analog output 1 - 12.9 / Analog output 2 + 12.10 / Analog output 2 - 18.9 / Analog output 3 + 18.10 / Analog output 3 -</p>  <p>The diagram shows a terminal block with multiple rows of terminals. The top row is labeled 'Analog Output 1' and has terminals 6.9 and 6.10. The second row is labeled 'Analog Output 2' and has terminals 12.9 and 12.10. The third row is labeled 'Analog Output 3' and has terminals 18.9 and 18.10. The diagram also shows other terminals for digital outputs and power supply connections.</p>

4 Electrical connection

4.4.4 Digital inputs/outputs

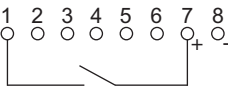
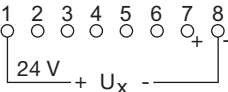
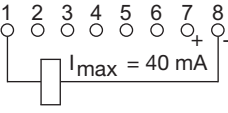
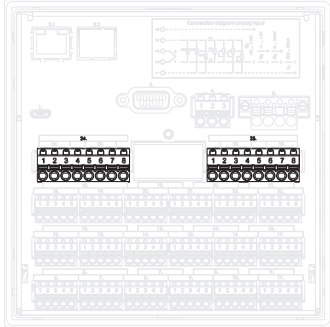
Version	Terminals and connection symbol	Connection element.terminal / assignment
<p>Digital input DC 0/24 V or digital output DC 0/24 V (individually switchable), auxiliary voltage supply DC 24 V</p> <p>Note regarding the digital option: Auxiliary voltage supply and digital outputs together deliver max. 100 mA (at 24 V).</p>	<div style="text-align: center;">  </div> <p>Example: potential-free contact on digital input/output 1 (as input) and +24 V (auxiliary voltage)</p> <div style="text-align: center;">  </div> <p>Example: external voltage on digital input/output 1 (as input) and GND</p> <div style="text-align: center;">  </div> <p>Example: external relay on digital input/output 1 (as output) and GND (max. 40 mA per output, max. 100 mA in total, see note in the "Version" column)</p>	<p>Digital option (order code 4):</p> <p>24.1 / Digital input/output 1 24.2 / Digital input/output 2 24.3 / Digital input/output 3 24.4 / Digital input/output 4 24.5 / Digital input/output 5 24.6 / Digital input/output 6 24.7 / +24 V 24.8 / GND</p> <p>25.1 / Digital input/output 7 25.2 / Digital input/output 8 25.3 / Digital input/output 9 25.4 / Digital input/output 10 25.5 / Digital input/output 11 25.6 / Digital input/output 12 25.7 / +24 V 25.8 / GND</p> <div style="text-align: center;">  </div>

4 Electrical connection

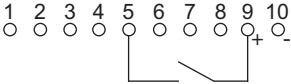
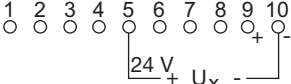
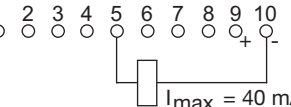
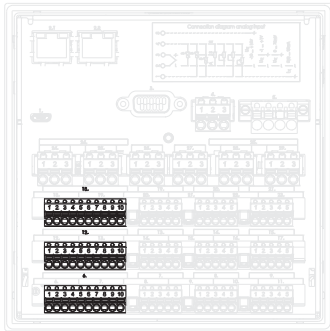
Version	Terminals and connection symbol	Connection element.terminal / assignment
<p>Digital input DC 0/24 V or digital output DC 0/24 V (individually switchable), auxiliary voltage supply DC 24 V</p> <p>Note regarding analog(HI)/digital option: Auxiliary voltage supply and digital outputs together deliver max. 50 mA per slot (at 24 V).</p>	<div style="text-align: center;">  </div> <p>Example: potential-free contact on digital input/output 13 (as input) and +24 V (auxiliary voltage)</p> <div style="text-align: center;">  </div> <p>Example: external voltage on digital input/output 13 (as input) and GND</p> <div style="text-align: center;">  </div> <p>Example: external relay on digital input/output 1 (as output) and GND (max. 40 mA per output, max. 50 mA in total, see note in the "Version" column)</p>	<p>Analog(HI)/digital option (order code 2):</p> <p>6.5 / Digital input/output 13 6.6 / Digital input/output 14 6.7 / Digital input/output 15 6.8 / Digital input/output 16 6.9 / +24 V 6.10 / GND</p> <p>12.5 / Digital input/output 17 12.6 / Digital input/output 18 12.7 / Digital input/output 19 12.8 / Digital input/output 20 12.9 / +24 V 12.10 / GND</p> <p>18.5 / Digital input/output 21 18.6 / Digital input/output 22 18.7 / Digital input/output 23 18.8 / Digital input/output 24 18.9 / +24 V 18.10 / GND</p> <div style="text-align: right;">  </div>

4 Electrical connection

4.4.5 Relays

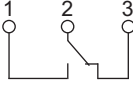
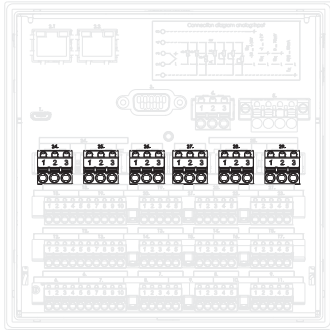
Version	Terminals and connection symbol	Connection element.terminal / assignment
Relay (changeover contact) (max. 3 A at AC 230 V, resistive load)		<p>As a standard feature:</p> <p>Relay 1: 4.1 / Normally open contact (NO) 4.2 / Common contact (C) 4.3 / Normally closed contact (NC)</p> <p>Relay option (order code 5):</p> <p>Relay 2: 24.1 / Normally open contact (NO) 24.2 / Common contact (C) 24.3 / Normally closed contact (NC)</p> <p>Relay 3: 25.1 / Normally open contact (NO) 25.2 / Common contact (C) 25.3 / Normally closed contact (NC)</p> <p>Relay 4: 26.1 / Normally open contact (NO) 26.2 / Common contact (C) 26.3 / Normally closed contact (NC)</p> <p>Relay 5: 27.1 / Normally open contact (NO) 27.2 / Common contact (C) 27.3 / Normally closed contact (NC)</p> <p>Relay 6: 28.1 / Normally open contact (NO) 28.2 / Common contact (C) 28.3 / Normally closed contact (NC)</p> <p>Relay 7: 29.1 / Normally open contact (NO) 29.2 / Common contact (C) 29.3 / Normally closed contact (NC)</p> 

4 Electrical connection

4.4.6 RS232/RS485 interface

Version	Connection element.pin / assignment	Connection element
RS232 9-pin SUB-D socket (switchable to RS485)	3.2 / RxD (received data) 3.3 / TxD (transmission data) 3.5 / GND (ground)	
RS485 9-pin SUB-D socket (switchable to RS232)	3.3 / TxD+/RxD+ (transmission/received data +) 3.5 / GND (ground) 3.8 / TxD-/RxD- (transmission/received data -)	

4.4.7 Ethernet/PROFINET

Version	Connection element.pin / assignment	Connection element
Ethernet 1 x RJ45 (as a standard feature)	2.1.1 / TX+ (transmission data +) 2.1.2 / TX- (transmission data -) 2.1.3 / RX+ (received data +) 2.1.6 / RX- (received data -)	
PROFINET IO device (incl. Ethernet) 2 x RJ45, integrated switch (as extra code)	2.1.1 / TX+ (transmission data +) 2.1.2 / TX- (transmission data -) 2.1.3 / RX+ (received data +) 2.1.6 / RX- (received data -) 2.2.1 / TX+ (transmission data +) 2.2.2 / TX- (transmission data -) 2.2.3 / RX+ (received data +) 2.2.6 / RX- (received data -)	

4.4.8 Voltage supply

Version	Connection element.terminal / assignment	Terminals and connection symbol
AC 110 to 240 V +10/-15 %, 48 to 63 Hz or AC/DC 20 to 30 V, 48 to 63 Hz Observe order details!	5.L1 / Line conductor (for DC: positive terminal L+) 5.N / Neutral conductor (for DC: negative terminal L-) 5.PE / Protection conductor	

4 Electrical connection

5.1 Operating concept

The device is equipped with a resistive touchscreen; the operation is menu-driven. User management protects the device against unauthorized access. The different users can be assigned different privileges so that they can only access specific functions.

In addition to the visualizations available per default, the setup program can be used to create individual process screens for presenting process data.

Thanks to the integrated web server, certain visualizations can also be rendered in a web browser.

5.1.1 Touchscreen

The visualization screen shown after switching on the device depends on the configuration (device: Main menu > Configuration > Display > Generally > Image after reset; also see the "Configuration" chapter in the operating manual).

The example shown here is the curve diagram (vertical, with digital traces).

View

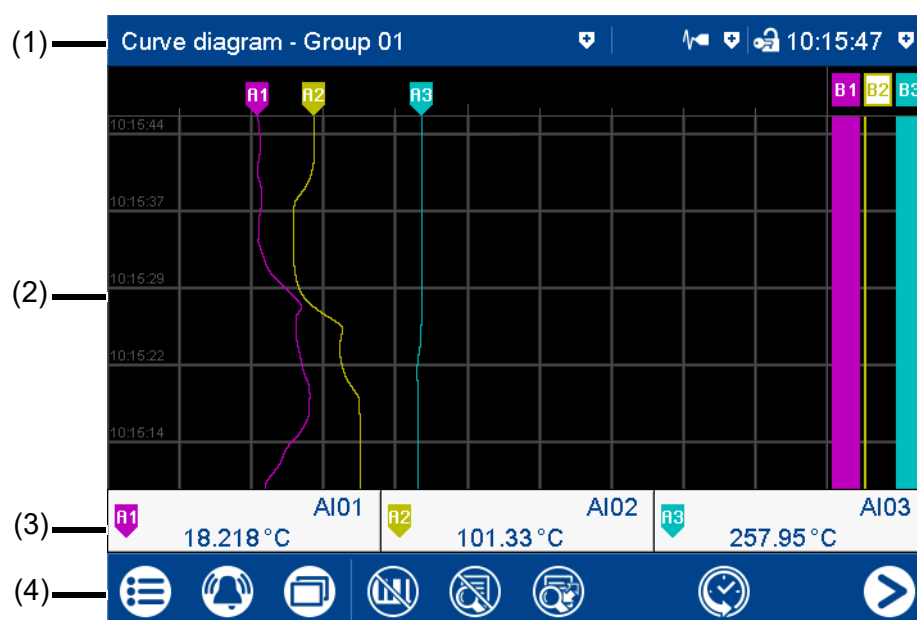

- | | |
|--|--|
| (1) Status bar | (2) Screen (here: curve diagram with digital traces) |
| (3) Channel information (display depends on the configuration) | (4) Navigation bar |

Status bar







The status bar consists of three areas which are delimited by vertical lines. Each area is an active button which can be used to display (⏵) and hide (⏴) further information.

The **area on the left** shows you the diagram type and group number. Tapping the button displays the alarm list.

The **area in the center** is used to display the status of the recording operating mode and communication types based on icons. The button displays details of the group operating mode (depending on the screen), the batch recording status, and the status of the data transfer via the PCC software as a text display.



Icons used:

5 Operation

Position	Meaning	Symbol
Left	Data transfer via PCC software	
	- Transfer active	
	- Transfer not active	No icon
Center	Batch recording	
	- Recording active	
	- Recording not active (or batch not configured)	No icon
Right	Operating mode	
	- Standard operation	
	- Event operation	
	- Time operation	

The **area on the right** shows the logon status as an icon and the time. The button additionally shows the weekday, date, user name, and memory usage.

Icons used:

Position	Meaning	Symbol
Left	Logon status	
	- User not logged on	
	- User logged on	

The status bar is also used as an **alarm display**. In the event of an alarm, the alarm text (red background) and the normal text (blue background) are alternately displayed.

Screen

The screen area displays the current visualization, a menu (e.g., main menu) with its menu items, or a list (e.g., event list).

Channel information



The channel information display in the curve diagram can be switched on and off (configuration). The designation (pointer) of the analog signal (e.g., A1) is displayed along with the abbreviation of the analog signal (e.g., AI01 for analog input 1) and the analog value.

Instead of the abbreviation, the designation (description) can also be displayed (configuration).

Navigation bar



The navigation bar consists of three areas which are delimited by vertical lines.

The **area on the left** contains the buttons (icons) for calling up

- the main menu (left),
- the alarm and event menu (center), and
- the visualization menu (right).

The **area in the center** contains buttons (icons) whose function depends on the screen currently being displayed.

The **area on the right** contains buttons (icons) for screen navigation:
The "Home" button takes the user directly to a specific screen (configurable).
Pressing the "Next" button (right arrow) selects the next screen on a specific level (e.g., toggle to the next active group).

5.1.2 LED displays

The device is equipped with two LEDs on its front side that display the device status.

Green LED

The green LED (power LED) flashes after switching on the device until the startup process is completed. It is then permanently lit.

Red LED

The red LED (alarm LED) is permanently lit while an alarm is present.
Acknowledging the collective alarm in the alarm list does not reset the alarm display.

5 Operation

5.2 Main menu



The main menu contains functions for configuring, parameterizing, and operating the device.

View

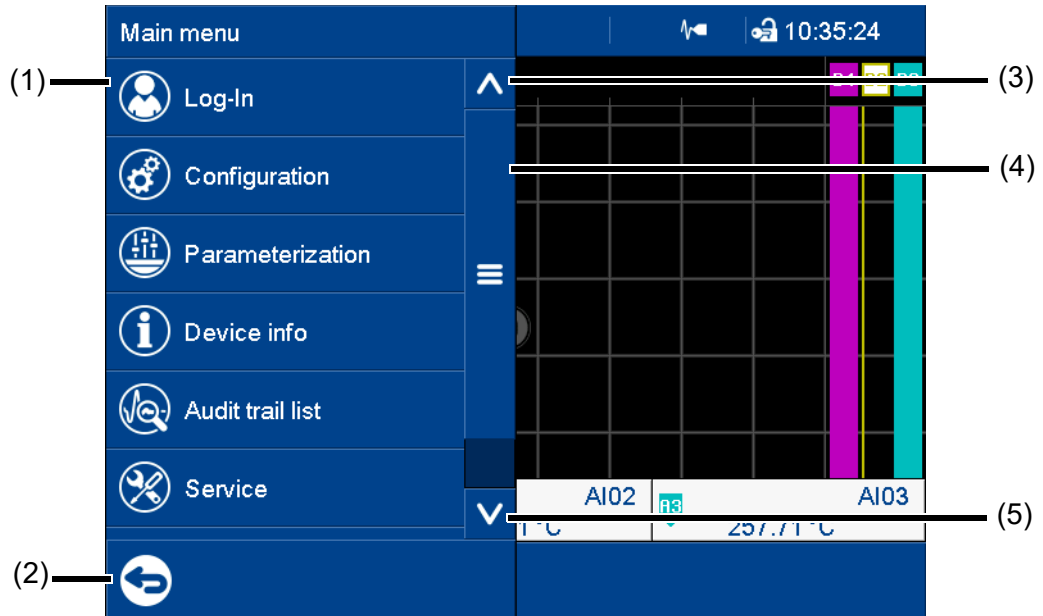

- (1) Menu items
- (2) Quit main menu
- (3) Scroll up
- (4) Scroll box (current position within the menu); movable
- (5) Scroll down

5.2.1 Logon



This is the menu in which users log on and off, and change their passwords.

The following IDs, names, and passwords are set by default:

Users	ID	Name	Password
User 1	Master	System Master	9200
User 2	User 1	Data Management	1
User 3	User 2	Data Management	2
User 4	User 3	Data Management	3
User 5	Service	Service	9200

Further information: see the operating manual, chapter "Configuration - only in setup program" > "User list" > "Default user settings".

Logoff with signature

With extra code 888 (FDA) and with the corresponding configuration in the PCS software, an electronic signature is required when logging off. The signature applies to the entire time period for which the user was logged on.

Configuration of the electronic signature: see operating manual, chapter "Configuration - only in setup program" > "Electronic signature".

Example of an electronic signature:

⇒ chapter 5.8 "Electronic signature", page 69

5.2.2 Configuration



This menu contains functions for configuring the device. The functions are available both on the device and in the setup program (see the "Configuration" chapter in the operating manual).

In addition to this, there are functions that can only be configured with the setup program (see the operating manual, chapter "Configuration - only in setup program" and "Online parameters").



CAUTION!

Changing the configuration closes the current capturing of recording data and means the new data is recorded such that it is chronologically separated from the old data (new configuration = new archive section). As a basic principle, the device only stores the recording data that has been captured during the last 20 configurations. However, irrespective of this, the oldest data is automatically overwritten with new data when the internal memory is full (ring buffer principle).

The data before and after the reconfiguration cannot be displayed as a whole in PCA3000. Data which is older than the last 20 configurations can no longer be extracted from the device.

- ▶ Before making any changes to the configuration, always create a backup of the data. It is also necessary to select suitable retrieval cycles for the data to prevent data loss. The setup program (configuration of the groups) provides a guideline value for the maximum data capture time.

5.2.3 Parameterization



This menu contains the functions for parameterizing the device (see the "Parameterization" chapter in the operating manual).

5.2.4 Device information



This menu contains information about the device (name, versions), the current process values (inputs, outputs, internal functions), the Ethernet interface, and the PROFINET interface (optional extra).

The device version is indicated through the "Version" parameter in the submenu "Versions" > "Basic device":

Standard = device in standard version

21 CFR Part 11 = device in FDA compliant version

With extra code 887 (digital certificate) or 888 (FDA) information about the digital certificate is also displayed in this menu.

5.2.5 Audit trail list



This menu lists the audit trail messages generated by the device.

All user intervention with the device is automatically recorded and stored in the audit trail list of the device. The audit trail list is managed independently of the event list.

The audit trail list is designed as a ring buffer which can contain a maximum of 150 entries. When the list is full, each new entry causes the oldest entry to be deleted from the list.

5 Operation

5.2.6 Service



This menu contains various service functions.

Default configuration

You can store the current device configuration with this function. Similarly, a previously stored configuration can be loaded as the current configuration.

5.2.7 Calibrating the touchscreen



This menu enables you to calibrate the touchscreen (position calibration). To do so, you need to tap the center of the crosshairs shown in the corners of the screen one after another.

5.3 Alarm and event menu



The alarm and event menu enables you to call up the alarm list and event list.

View

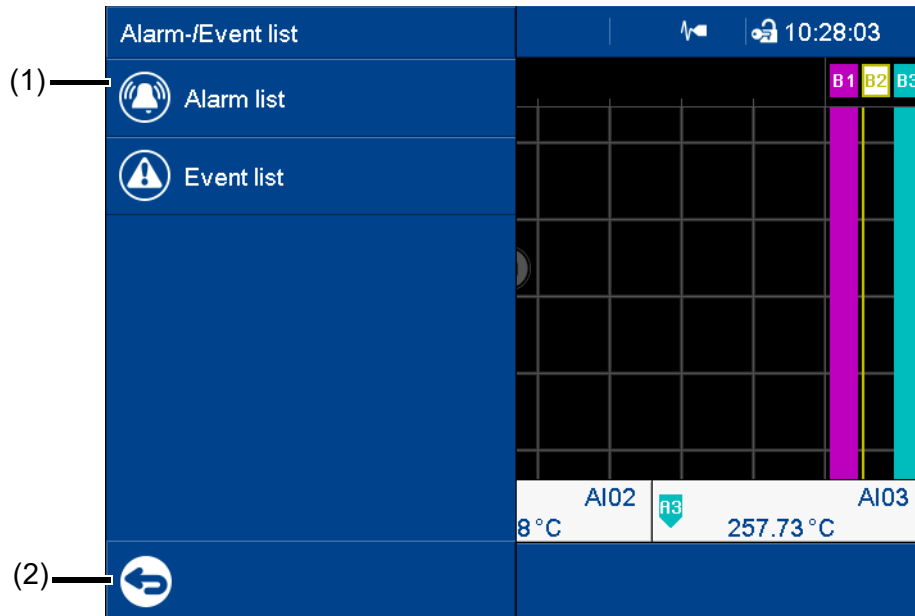

- (1) Menu items
- (2) Quit the alarm and event menu

Alarm and event lists of the batches

A separate alarm list and event list exists for each active batch (in addition to the overall list). These separate lists contain batch-related entries based on the group assignment (events and alarms of the channels and counters/integrators).

5.3.1 Alarm list



The alarm list shows all alarms that are present in their order of occurrence. If an alarm is no longer present, its entry is automatically removed from the alarm list. The alarm list is rebuilt after power on.

Each alarm represents an event. For this reason, the time at which an alarm occurs and disappears again is recorded in the event list.

An alarm that is present is additionally shown in the status bar and by the red LED.

View

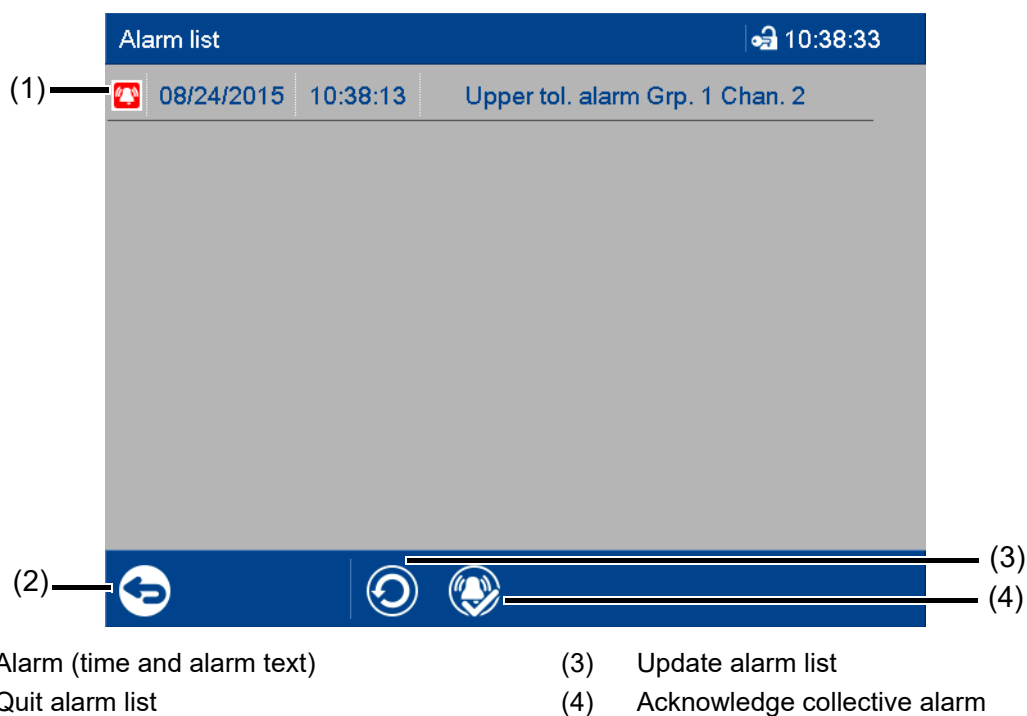

Collective alarm

The following collective signals are created and are available in the digital selector:

- **Collective alarm**
The signal is active while an alarm is present (the alarm list is not empty).
- **Collective alarm acknowledged**
This signal is activated when an alarm occurs; it remains active until acknowledged even if the alarm disappears in the meantime.

5 Operation

5.3.2 Event list



The event list contains event entries in chronological order. A maximum of 150 entries are stored and displayed. When new entries are added, the oldest entries are deleted. The event list is kept after power off.

As with process data, events are transferred to the PC Evaluation Software PCA3000 for evaluation.

The events include:

- System messages (e.g., power on, configuration change, time sync)
- Device alarms (malfunctions; e.g., battery discharged, data loss, input not calibrated)
- Configured alarms
- Configured events
- Counter messages (counter status and counter reset)
- Batch messages (start and end of batch recording)
- General messages (e.g., comments, error messages from the interfaces, USB flash drive plugged in/removed, collective alarm acknowledged)

View

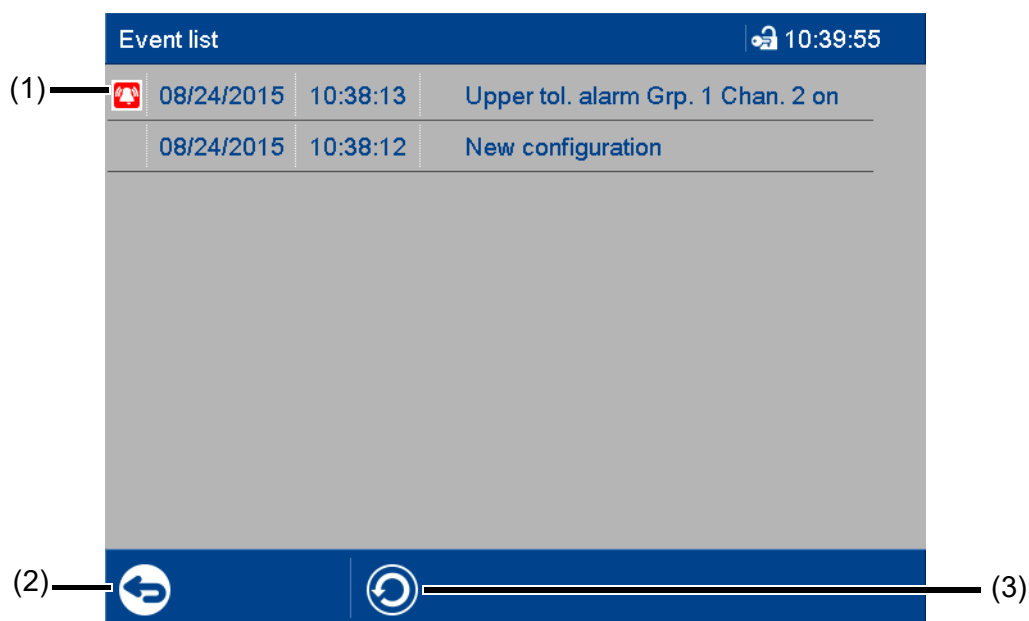

(1) Event (here: alarm) with time and event text (configurable)

(3) Update event list

(2) Quit event list

Event list in memory view

If the alarm and event menu is called up from the memory view (history) (or from the curve presentation of a completed batch), the event list is opened directly. An additional button is available here which lets you mark the time of a specific event in the memory view with the cursor position.

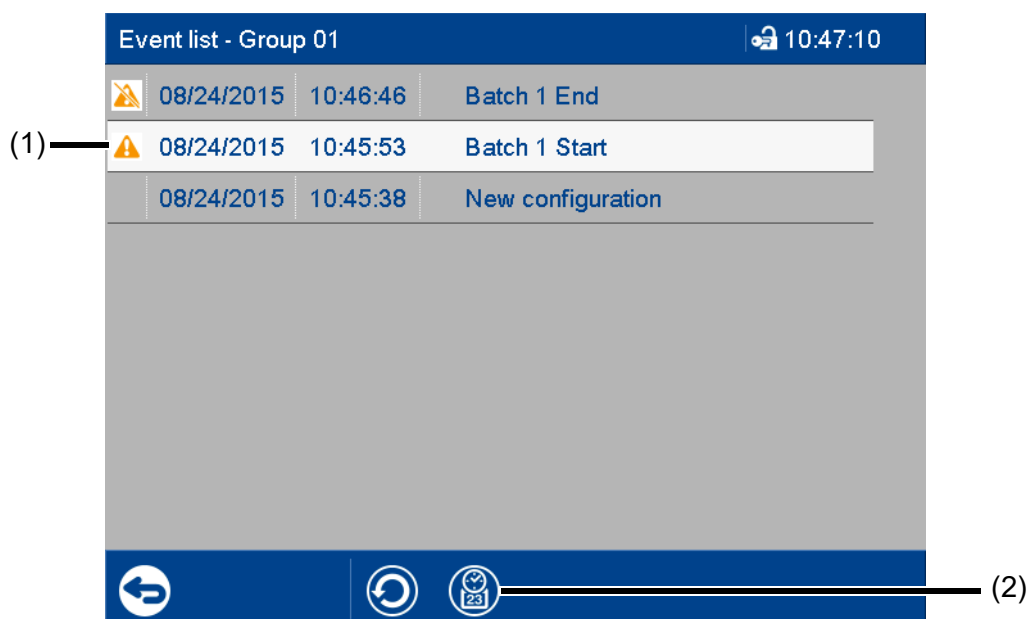

(1) Selected event
The event is selected by tapping.

(2) Call up memory view
In the memory view, the cursor is moved to the position (time) at which the event occurred.
If the respective point in time is no longer in the history, the cursor is moved to the start of the memory view (oldest point in time).

5 Operation

5.4 Visualization menu (display)



In the visualization menu, the display type and group that should currently be displayed on the device are selected. Up to 6 analog channels and 6 digital channels of a group can be shown on one screen.

View

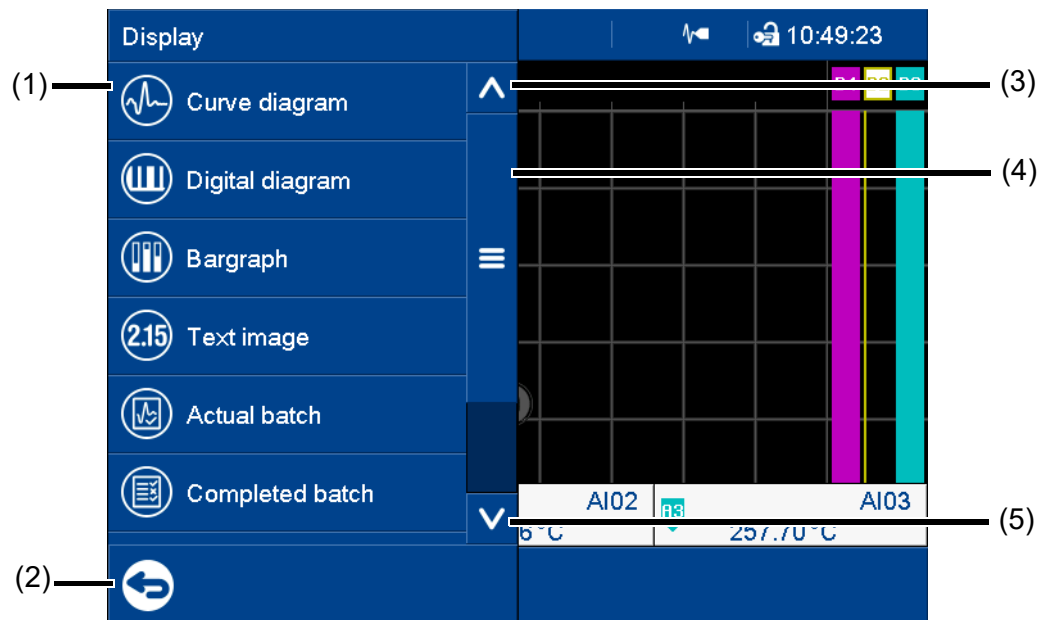

(1) Menu items

(2) Quit visualization menu

(3) Scroll up

(4) Scroll box (current position within the menu); movable

(5) Scroll down

5.4.1 Curve diagram



In the curve diagram, the analog and digital signals configured for the relevant group are displayed as analog curves or digital traces. Digital traces and channel information can be hidden in the group configuration.

The diagram type (horizontal, vertical) is selected individually for each group in the configuration. The following view shows the vertical diagram. Accordingly, the description also applies to the horizontal diagram (see the example later on).

Group view

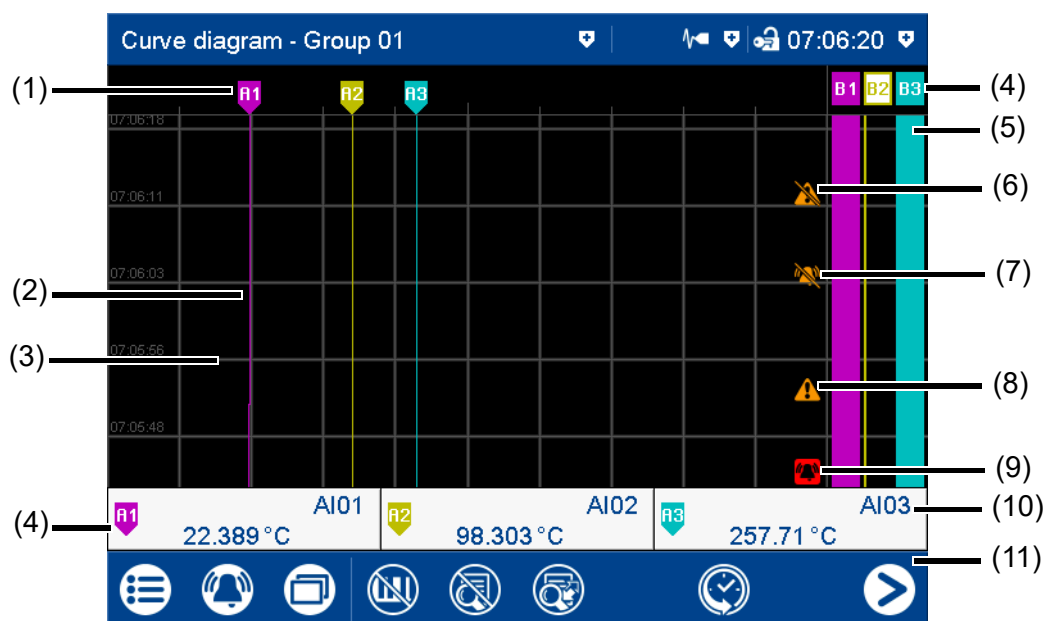

- | | |
|--|---|
| (1) Designation (pointer) of the analog curve | (4) Designation (pointer) of the digital trace |
| (2) Analog curve (color change in the event of an alarm) | (5) Digital trace |
| (3) Auxiliary line (configurable) | (6) Event off |
| (4) Channel information: designation (pointer), signal abbreviation (configurable), and current value of analog signal (color change in the event of an alarm) | (7) Alarm off |
| Touch the button to display the channel individually (incl. scaling and limit values). | (8) Event on |
| | (9) Alarm on |
| | (10) Signal description (instead of abbreviation) |
| | (11) Navigation bar |

Navigation bar



- | | |
|-----------------------------------|-----------------------------------|
| (1) Hide/show digital traces | (4) Call up memory view (history) |
| (2) Hide/show channel information | (5) Go to next active group |
| (3) Hide/show analog values | |

5 Operation

Memory view (history)

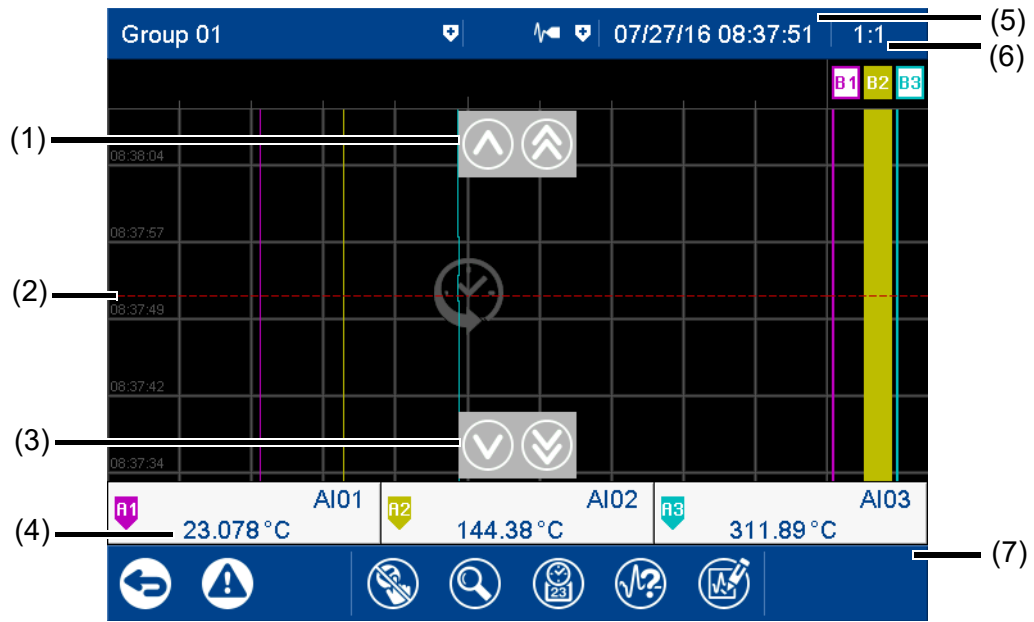

- | | |
|---|---|
| (1) Move time for memory values forward (later memory values) | (5) Time of memory values (cursor position) |
| (2) Cursor (time of numeric memory values) | (6) Zoom factor |
| (3) Move time for memory values back (earlier memory values) | (7) Navigation bar |
| (4) Analog value at selected time | |

Navigation bar

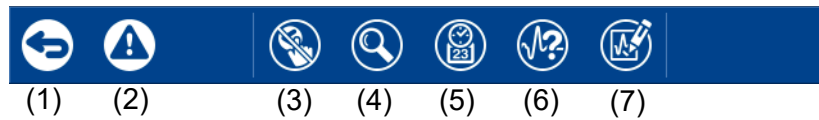

- | | |
|---------------------------|---|
| (1) Quit memory view | (4) Change zoom factor |
| (2) Access event list | (5) Find memory values (enter time) |
| (3) Hide/show cursor keys | (6) Curve selection (activate/deactivate view) |
| | (7) Render electronic signature or display information about rendered signature |

Electronic signature

With extra code 888 (FDA) and with the corresponding configuration in the PCS software, a certain time period can be provided with an electronic signature. The signature applies to the time period that is displayed in the diagram at the time of the signature. The displayed period may have to be expanded prior to signing. During signing the time period can only be reduced; it can then no longer be expanded.

Any user who has the corresponding authorization can sign the signature ("Confirm batches, electronic signature" right). This can be a different user to the one who is currently logged on.

Configuration of the electronic signature: see operating manual, chapter "Configuration - only in setup program" > "Electronic signature".

Example of an electronic signature:

⇒ chapter 5.8 "Electronic signature", page 69

Horizontal diagram

In the horizontal diagram, the analog curves and digital traces run from right to left. The channel information is shown on the right edge of the screen; the icons for event and alarm at the top edge of the screen.

Digital traces and channel information can be hidden in the group configuration, as in the vertical view.

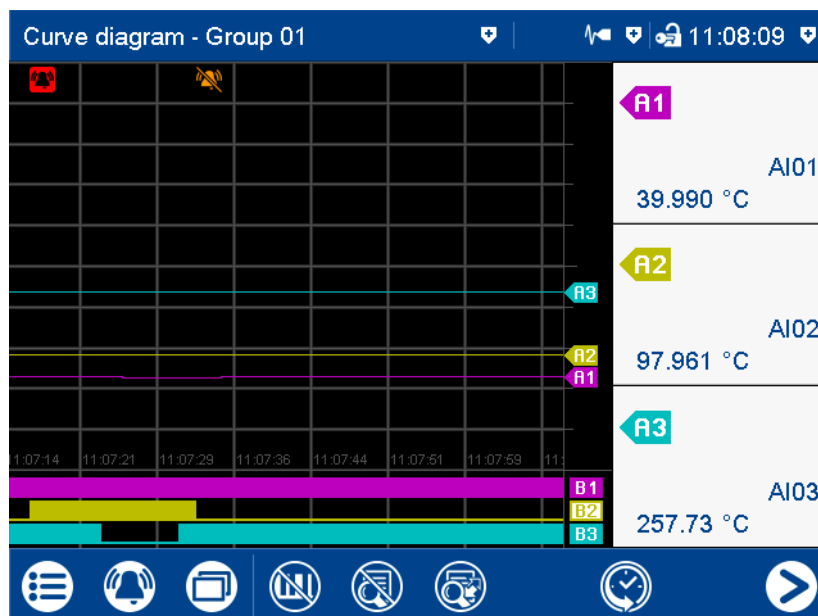

5 Operation

5.4.2 Digital diagram



In the digital diagram, the digital signals configured for the relevant group are displayed as digital traces. The diagram type (horizontal, vertical) is selected individually for each group in the configuration. The following view shows the vertical diagram. Accordingly, the description also applies to the horizontal diagram.

Group view

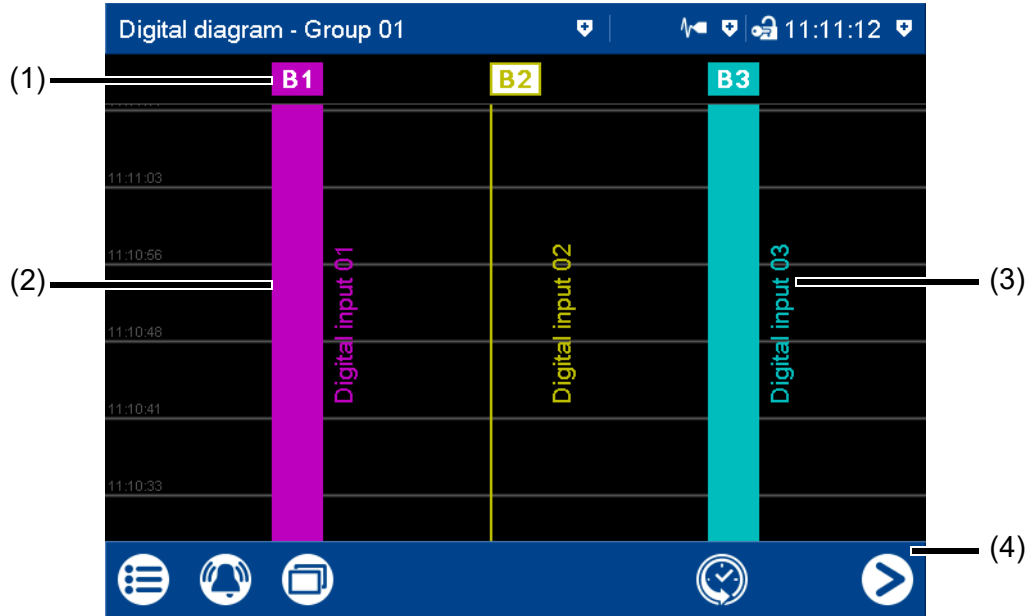

- (1) Designation (pointer) of the digital trace
Displays the logical state:
Colored area = HIGH (B1, B3)
Colored frame = LOW (B2)
- (2) Digital trace
- (3) Signal designation of digital signal (configurable)
- (4) Navigation bar

Navigation bar



- (1) Call up memory view (history)
- (2) Go to next active group

Memory view

See memory view in the curve diagram.
⇒ chapter 5.4.1 "Curve diagram", page 47

5.4.3 Bar graph



In the bar graph view, the analog signals configured for the relevant group are shown as bar graphs, and the digital signals – depending on their logical state – as colored areas or frames.

The diagram type selected for the group (horizontal, vertical) is irrelevant for the bar graph view. The view is always as a column diagram (vertical) and not as a bar diagram (horizontal).

Group view

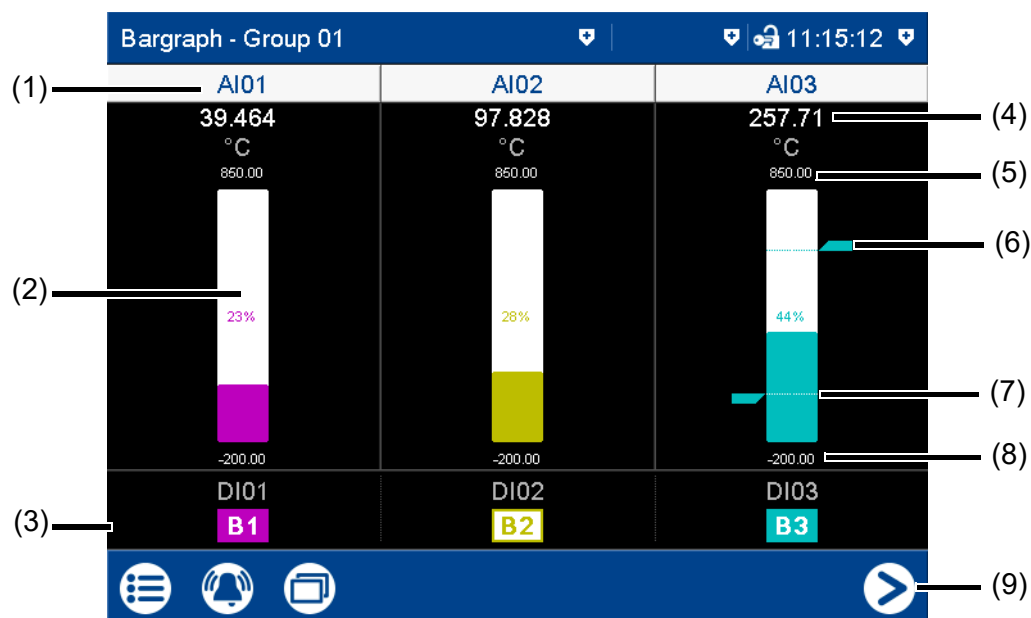

- | | |
|---|--|
| <p>(1) Signal abbreviation (configurable) of analog signal
Call up individual view of analog signal (numerical view and bar graph); see text image - individual view.</p> <p>(2) Bar graph of the analog signal (color change in the event of an alarm)</p> <p>(3) Digital signal with signal abbreviation (configurable) and designation (pointer)
Displays the logical state:
Colored area = HIGH (B1, B3)
Colored frame = LOW (B2)</p> | <p>(4) Current analog value (color change in the event of an alarm)</p> <p>(5) End value of scaling (display range, configurable)</p> <p>(6) Limit value for max. alarm (configurable)</p> <p>(7) Limit value for min. alarm (configurable)</p> <p>(8) Start value of scaling (display range, configurable)</p> <p>(9) Go to next active group</p> |
|---|--|

5 Operation

5.4.4 Text image



The text image shows the current values for the analog signals configured for the relevant group as numbers. The digital signals – depending on their logical state – are shown as colored areas or frames.

Group view

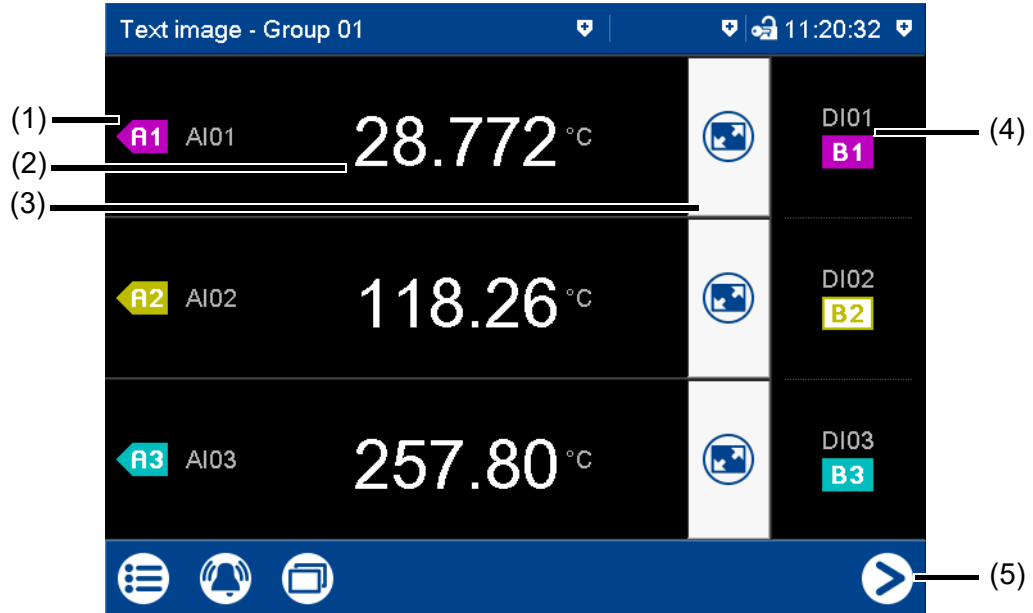

- | | |
|---|---|
| (1) Designation (pointer) and signal abbreviation (configurable) of the analog signal | (4) Digital signal with signal abbreviation (configurable) and designation (pointer)
Displays the logical state:
Colored area = HIGH (B1, B3)
Colored frame = LOW (B2) |
| (2) Current value of analog signal | |
| (3) Call up individual view of analog signal (numerical view and bar graph)
In the individual view, all digital signals of the group are also displayed. | (5) Go to next active group |

Individual view

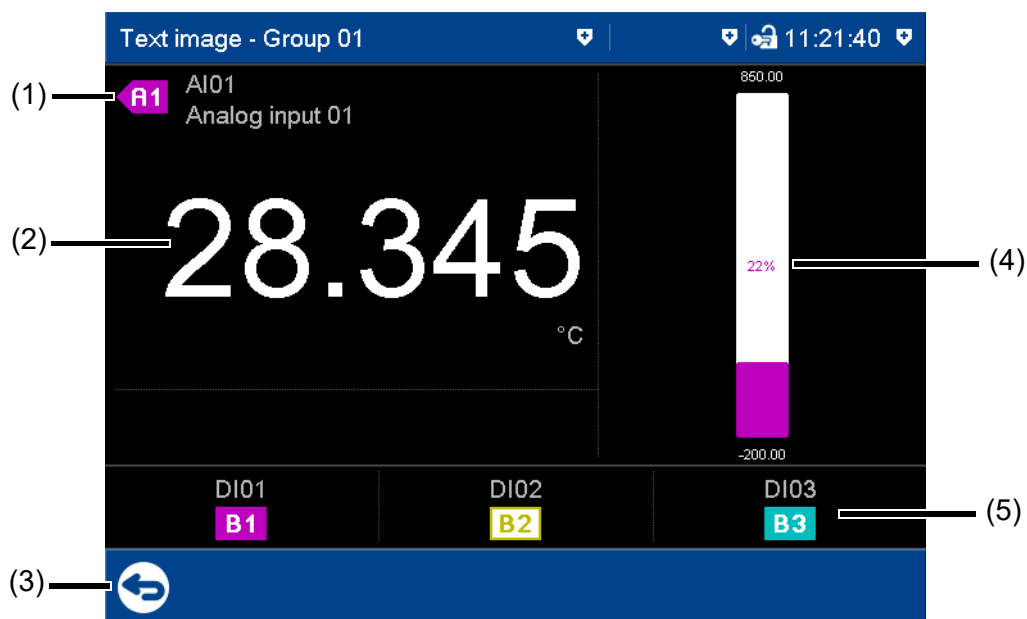

- | | |
|--|--|
| <p>(1) Designation (pointer), signal abbreviation (configurable), and signal designation (configurable) of the analog signal</p> <p>(2) Current value of analog signal</p> <p>(3) Back to group view</p> | <p>(4) Bar graph (column diagram) of the analog signal</p> <p>(5) Digital signal with signal abbreviation (configurable) and designation (pointer)
Displays the logical state:
Colored area = HIGH (B1, B3)
Colored frame = LOW (B2)</p> |
|--|--|

5 Operation

Individual view with alarms

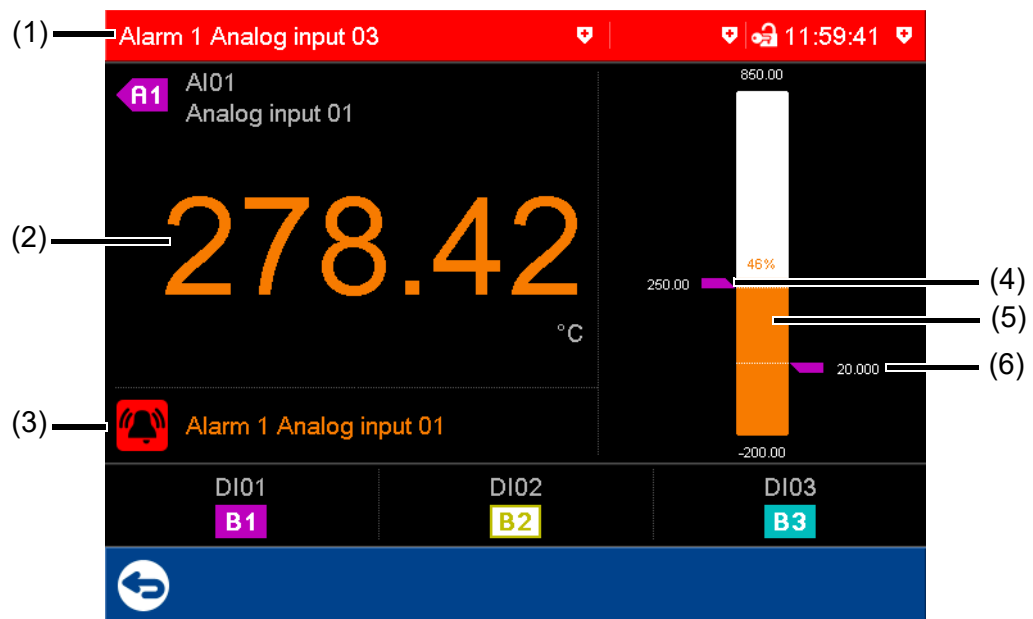

- | | |
|--|---|
| (1) Last alarm to have occurred (here: from analog input 03) | (4) Limit value for max. alarm (configurable) |
| (2) Current value of analog signal with color change (alarm) | (5) Bar graph (column diagram) of analog signal with color change (alarm) |
| (3) Alarm text of analog input | (6) Limit value for min. alarm (configurable) |

5.4.5 Report



A report shows the statistical information for the relevant group. A report contains the maximum, minimum, and average values of the analog signals during the recording time (the recording period is configurable). A distinction is made between the current (ongoing) report and the completed report.

To create a report, it must be activated in the configuration for the relevant group.

View

	Maximum value °C	Minimum value °C	Average value °C
(1) AI01			
(2)			
(3) External	297.25	53.689	175.49

- (1) Designation (pointer) and signal abbreviation (configurable) of the analog signal
- (2) Values of analog signal in the current (not completed) report
The type (configurable; here: external) decides when the report is stored and thus completed.
- (3) Call up detailed view of analog signal
- (4) Go to the next analog signal within the group
- (5) Go to the report for the next group

5 Operation

Detailed view

Report - Group 01			13:38:33
(1) External AI01	Current °C	(4) Completed °C	
(2) Maximum value	200.76	292.60	
Time	08/24/2015 13:38:22	08/24/2015 13:37:51	
Minimum value	84.126	80.773	
Time	08/24/2015 13:38:18	08/24/2015 13:37:40	
Average value	114.45	174.49	
(3) Timestamp start	08/24/2015 13:38:13	08/24/2015 13:37:23	
Timestamp end	08/24/2015 13:38:34	08/24/2015 13:38:10	
			(6)

- | | |
|--|------------------------------|
| (1) Designation (pointer) and signal abbreviation (configurable) of analog signal; report type (configurable; here: external) | (4) Completed report |
| (2) Time at which the max. value (or min. value) occurred | (5) Current (ongoing) report |
| (3) Time stamp for current report: beginning of recording and current time
Time stamp for completed report: beginning and end of reporting period | (6) Back to previous view |

5.4.6 Current batch



This function opens the report for the current batch recording. Batch recording can be started and stopped (depending on the configuration).

The report layout is defined in the batch configuration. This is where the individual lines of the report are defined, and the text for the left column, and content of the right column, are specified (device: main menu > Configuration > Batch > Batch line x; see also the "Configuration" chapter in the operating manual).

View

Actual batch - Batch 1		13:43:33
Program name	Text 1	(3)
Customer info	Text 3	
Batch name	Text 5	
Batch number	00000020Text 7	(4)
Batch start	08/24/2015 13:43:08	
Batch end	08/24/2015 13:43:32	
Batch duration	00:25	
		(5)

- | | |
|------------------|--|
| (1) Left column | (3) Editable text (depending on the configuration) |
| (2) Right column | (4) Batch number and non-editable text (depending on the configuration) |
| | (5) Stop/start batch recording (only for configured "Batch start via touchscreen") |

5 Operation

5.4.7 Completed batch



This function displays the report for the completed batch recording. Recorded data can be shown as a report and as a curve diagram.

If necessary, the report can also display the data from current batch recording.

View

Completed batch - Batch 1	
Program name	Text 1
Customer info	Text 3
Batch name	Text 5
Batch number	000000012Text 7
Batch start	07/27/2016 09:48:15
Batch end	07/27/2016 09:48:23
Batch duration	00:09



(1) Open report (statistical information for the completed batch recording, and, if necessary, the current batch recording)

(2) Open curve presentation (analog curves and digital traces of the completed batch recording)

(3) Render electronic signature or display information about rendered signature

Electronic signature

With extra code 888 (FDA) and with the corresponding configuration in the PCS software, the completed batch can be provided with an electronic signature. The signature can only be provided once per completed batch; it cannot be revoked. If a signature was provided already then this state is displayed through the following symbol (3): 

Any user who has the corresponding authorization can sign the signature ("Confirm batches, electronic signature" right). This can be a different user to the one who is currently logged on.

Configuration of the electronic signature: see operating manual, chapter "Configuration - only in setup program" > "Electronic signature".

Example of an electronic signature:

⇒ chapter 5.8 "Electronic signature", page 69

Report for batch

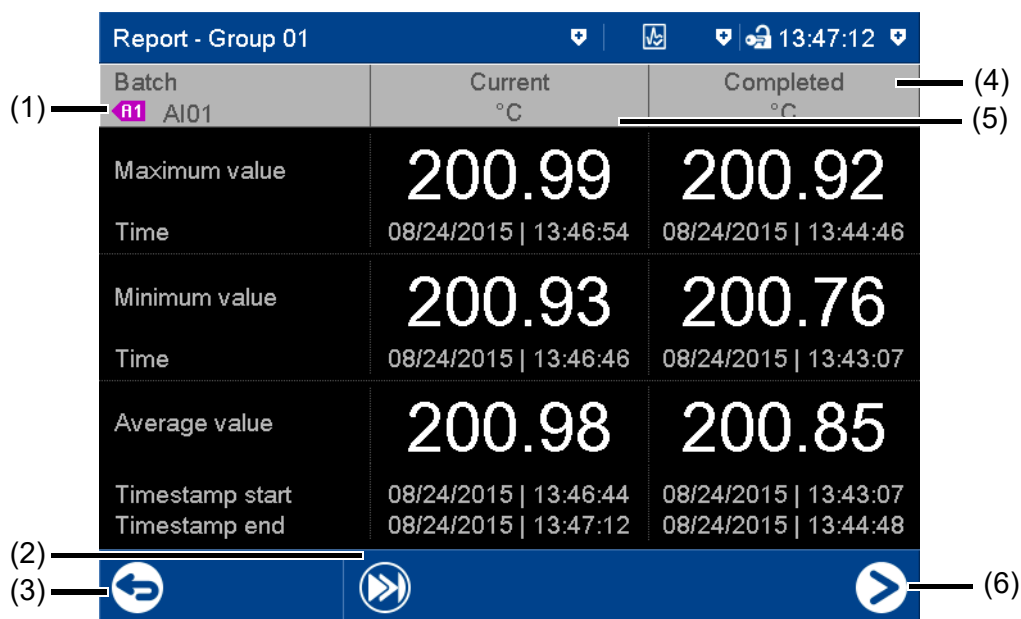

- (1) Designation (pointer) and signal abbreviation (configurable) of the analog signal
 - (2) Go to the next analog signal within the group
 - (3) Back to the batch report view
 - (4) Data (statistical information) for the completed batch recording
 - (5) Data (statistical information) for the current (ongoing) batch recording
 - (6) Go to next group
- ⇒ chapter 5.4.5 "Report", page 55

Curve presentation for the batch

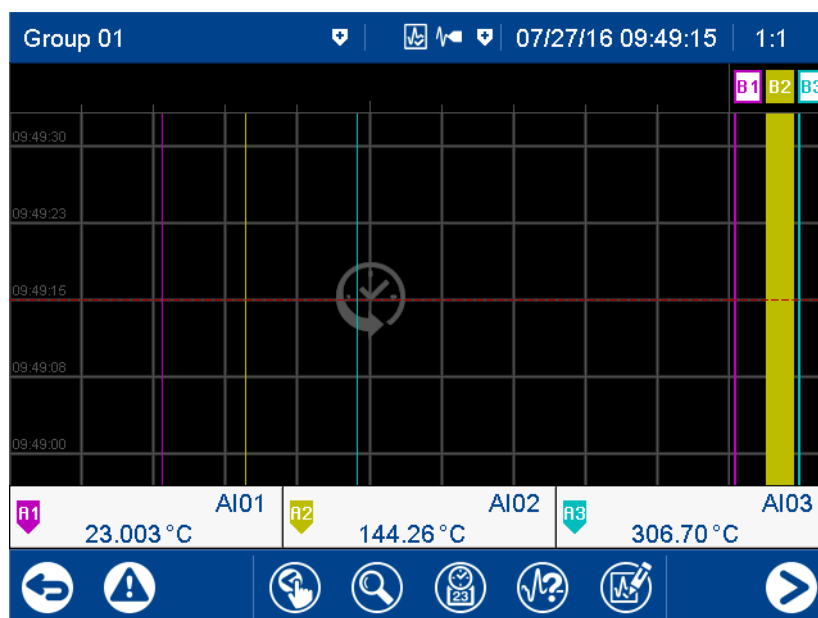

The functions are identical to those of the memory view in the "Curve diagram" visualization.

⇒ chapter 5.4.1 "Curve diagram", page 47

When opening the curve presentation, the zoom factor is computed so as to display the data of the entire batch recording on the screen.

5 Operation

5.4.8 Process screen



This visualization shows the individual process screens. You can use the arrow keys in the navigation bar to change to the next process screen.

Process screens can be created with the setup program and transferred to the device. For a process screen to be displayed, it must be activated (configuration parameters in the setup program; see operating manual, chapter "Configuration - only in setup program" > "Process screens").

5.4.9 Counter/integrator



This visualization shows all activated counters/integrators.

View

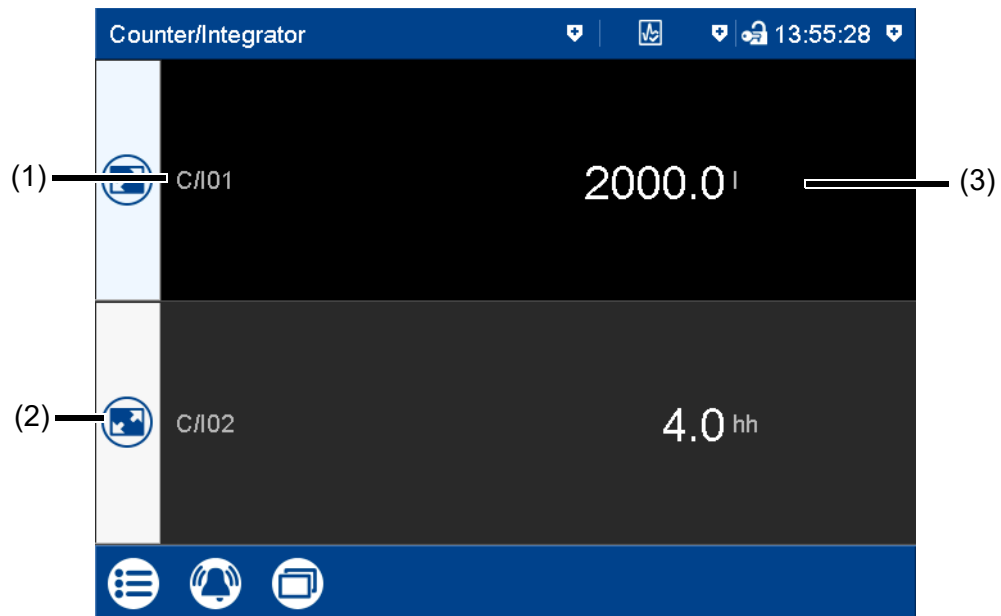

- (1) Abbreviation (configurable) of the counter/integrator
- (2) Open detailed view of the counter/integrator

- (3) Current status of the counter/integrator (unit configurable)

Detailed view

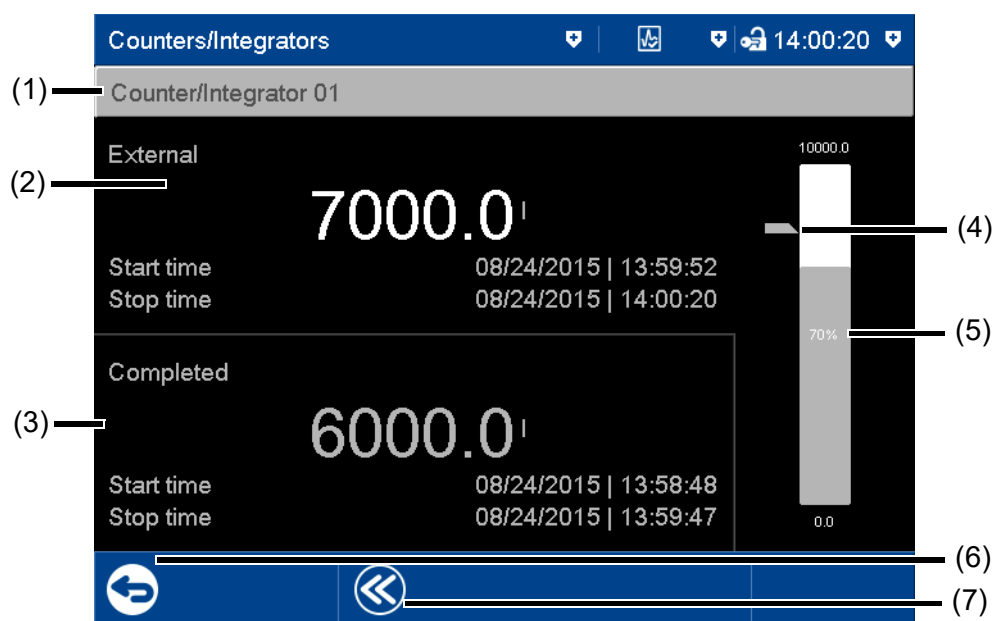

- | | |
|--|--|
| (1) Designation (configurable) of the counter/integrator | (4) Limit value for max. alarm (configurable) |
| (2) Specifications on current counter/integrator
The type (configurable; here: external) decides when the status is stored and the counter/integrator thus completed. | (5) Bar graph view of the current counter/integrator
Start and end of the display range are configurable. |
| (3) Specifications on the completed counter/integrator | (6) Back to view of all activated counters/integrators |
| | (7) Display of the last 7 completed counter/integrator statuses |

5.4.10 Comment text



This function can be used to enter a text (max. 160 characters) that is entered in the event list after completing the entry.

⇒ chapter 5.5 "Text input dialog", page 62

The comment text is assigned either only to the group in question or to all groups. The assignment depends on the visualization that the device is in when the function is called up.

In the case of the following visualizations, the comment text is assigned to all groups: current batch, completed batch, process screen, counter/integrator

In the case of the following visualizations, the comment text is only assigned to the group in question: curve diagram, digital diagram, bar graph, text image, report

The assignment to a certain group applies when only the event list of a certain group is displayed (memory view, curve presentation of the completed batch). In addition, the PCA3000 PC evaluation software can filter the events according to groups.

Comment with authentication

Depending on the "Comment with authentication" parameter, the user ID and password are required to enter a comment text (see operating manual, chapter "Configuration - only in the setup program" > "User list" > "Password rules").

5 Operation

In the case of a device that has extra code 888 (FDA), the setting in question is performed using the PCS software.

The approach when entering a comment with authentication basically corresponds to the one when rendering an electronic signature for a completed batch (only steps 2 to 4).

Example of an electronic signature:

⇒ chapter 5.8 "Electronic signature", page 69

5.5 Text input dialog

The text input dialog is used for all functions in which the user can enter or edit text.

Example: Configuration of an analog input

(1) Editable text (max. 5 characters)

(3) Drop-down menu (text not editable)

(2) Editable text (max. 21 characters)

Tap the text field to edit the text.

Text input dialog

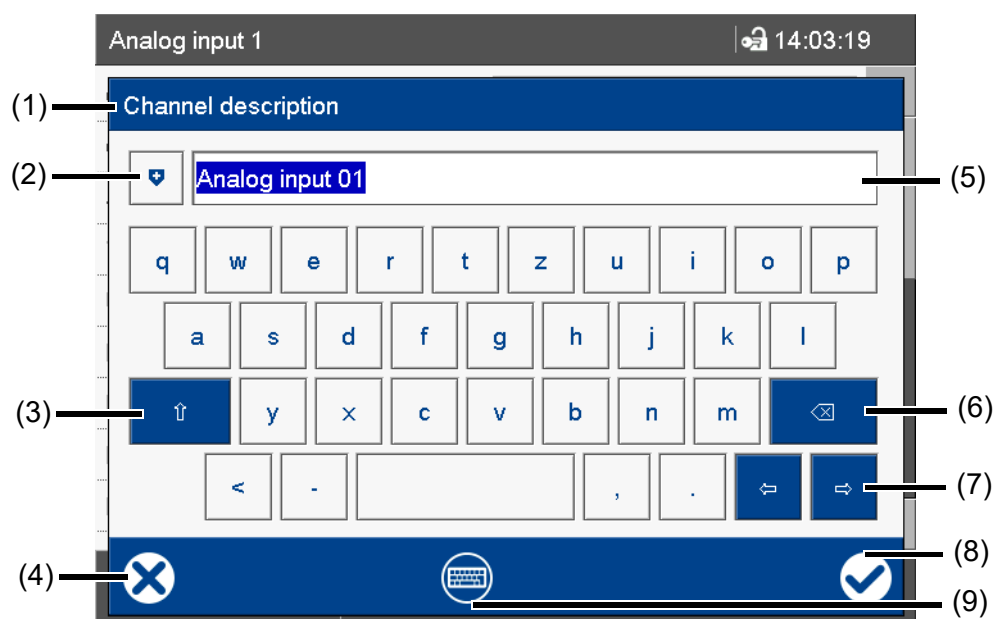

- | | |
|--|--|
| <p>(1) Parameter (designation of the configuration parameter from the previous dialog)</p> | <p>(5) Input box with current text
After changing to the text input dialog, the current text is fully selected. Tapping on the input box displays a cursor. Tapping and dragging the cursor lets you select multiple characters.</p> |
| <p>(2) Open text list (history of last 20 text entries)
The text from the list replaces the text in the input box.</p> | <p>(6) Backspace key
The character to the left of the cursor is deleted. If multiple characters are selected, they are deleted.</p> |
| <p>(3) Shift key (toggle to the second level of the current keyboard layout, e.g., upper-case)
To hold, you need to press the key for longer. To reset, (briefly) press the key again.</p> | <p>(7) Cursor keys (move cursor left or right)</p> |
| <p>(4) Cancel text entry (input is not applied)</p> | <p>(8) Complete text entry (input is applied)
(9) Toggle keyboard layout (for example letters, digits, non-standard characters)</p> |

5 Operation

Keyboard mappings

Each of the 30 keys in the default keyboard layout can be mapped with up to 10 characters. The Shift key toggles between the first two characters. To select more characters, you need to hold down the relevant key for longer. This displays a selection window in which you can select the desired character by tapping.



- (1) Multiple assignment of the "a" key
To leave the selection window without selecting a character, tap on the screen outside of the selection window.

More examples of multiple assignments of individual keys:

q Q @
s S ß
< > | '

Keyboard layout

The "Keyboard layout" key enables you to switch between the various keyboard layouts (keyboard assignments) (e.g., letters, digits, non-standard characters).

In the default keyboard layout (e.g., letters), each key can be assigned up to 10 characters. In the other keyboard layouts, only one character per key is possible.

The keyboard can be assigned individually for each language with the setup program (max. 6 layouts).

5.6 Flash manager

The Flash Manager menu automatically opens when the device is in basic status and a USB flash drive (FAT16/FAT32 file system) is plugged into the front USB port. If the device is in a menu (main menu, alarm and event list, display), the Flash Manager is opened only after exiting the menu.

Device dialog box

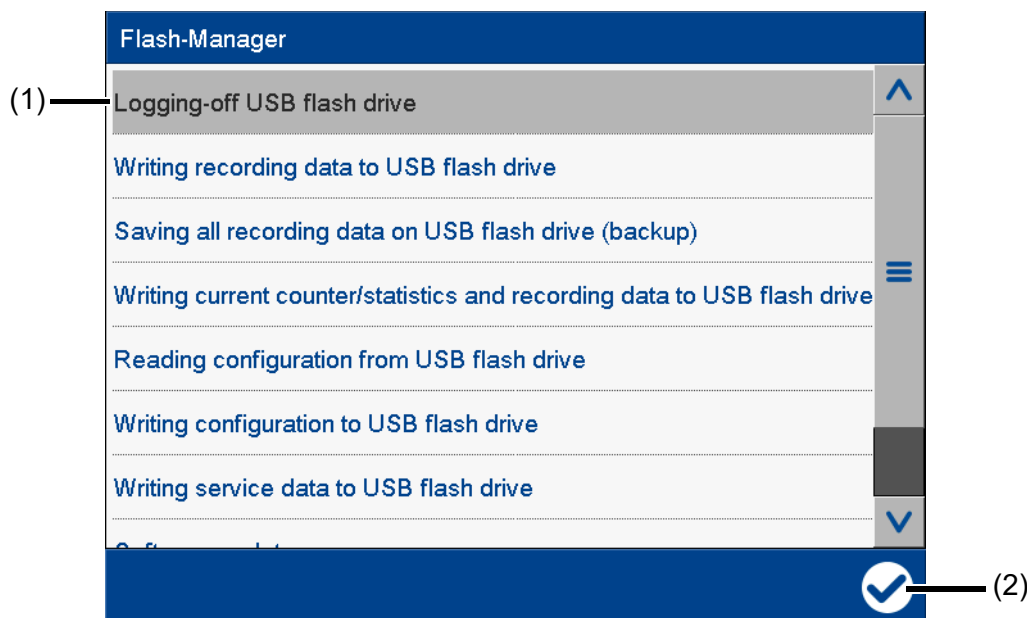

(1) Flash manager functions

(2) "Apply" button

The selected function is grayed out.

The Flash Manager provides functions for transferring specific data between the device and a USB flash drive. The available functions depend on the logged-on user's rights, or on the public rights. The selected function is performed by pressing the "Apply" button (check mark).



CAUTION!

Do not remove the USB flash drive without ejecting it.

There is a risk of losing data.

- ▶ Before removing the USB flash drive, always run the "Eject USB flash drive" function. Do not remove the USB flash drive until you see the "Safe to remove hardware" message.

Flash manager functions

- **Ejecting USB flash drive:**
Function for safely removing the USB flash drive to avoid data loss
- **Writing recording data to USB flash drive:**
Any recording data not yet backed up is written to the USB flash drive (retrieving the data). When this function is called up again, only the newly added recording data since the last run is transferred to the USB flash drive
- **Saving all recording data on the USB flash drive (backup):**
All recording data available on the device (including previously backed-up data) is transferred to the USB flash drive (data backup). It can take up to 30 minutes to execute this function!
The user can choose a time period from which the recording data is saved. The "Total" time period corresponds to the previous function. For the other time periods (1 day, 1 week, 4 weeks) the determined starting time is displayed and updated (see example further down). Here, the user can also

5 Operation

choose any starting time in the past. Using the additional parameter "Save counters/reports" it is possible to save the current readings of the counters and integrators as well as the statistics (report) – even if they have not yet been completed – along with the recording data.

- **Writing current counter/statistics and recording data to the USB flash drive:**
The current counter and integrator statuses, as well as the statistics (report) are read out, and written to the USB flash drive along with the newly added recording data.
- **Reading configuration from USB flash drive:**
The configuration data (except the user list) is transferred from the USB flash drive to the device. This reconfigures the device and data recording is restarted.
- **Writing configuration to USB flash drive:**
The configuration data (incl. the user list) is transferred from the device to the USB flash drive.
- **Writing service data to USB flash drive:**
Internal service data is transferred to the USB flash drive and can be sent to the device manufacturer for diagnosis.
- **Software update:**
Function for updating the device software; the USB flash drive must contain specific files provided by the device manufacturer.
- **Reading user list from USB flash drive:**
The user list is transferred from the USB flash drive to the device and activated.



CAUTION!

Data loss due to software update.

A software update deletes all recording data stored on the device (incl. counters/integrators and statistics).

- ▶ Before updating the software, save (back up) the recording data on a USB flash drive.
-

Saving the recording data of a certain time period

In the following example the recording data of a week should be saved.

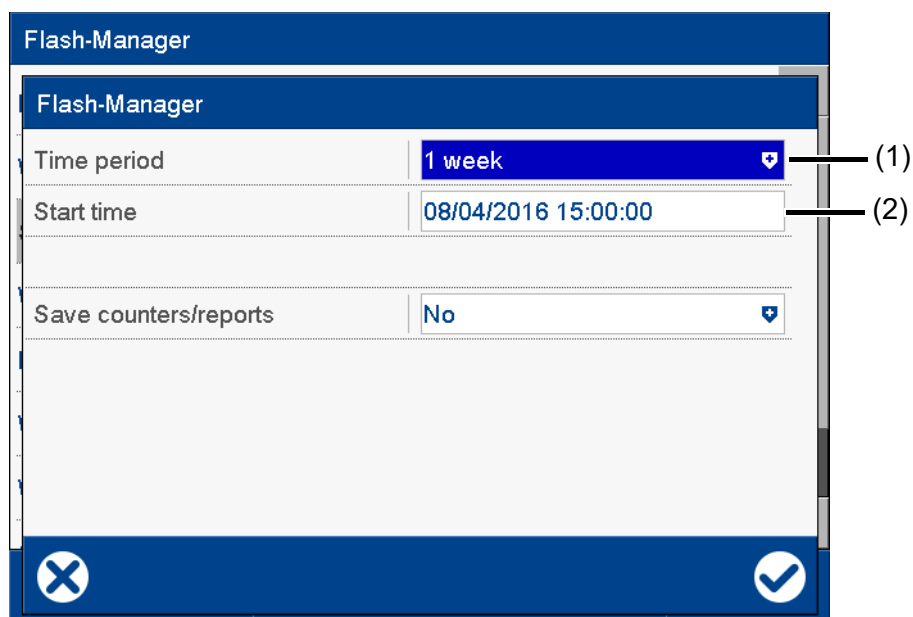

The screenshot shows a 'Flash-Manager' dialog box with the following fields:

- Time period:** A dropdown menu set to '1 week', with a callout line labeled '(1)' pointing to it.
- Start time:** A text field containing '08/04/2016 15:00:00', with a callout line labeled '(2)' pointing to it.
- Save counters/reports:** A dropdown menu set to 'No'.

At the bottom of the dialog box, there are two buttons: a blue 'X' button on the left and a blue checkmark button on the right.

(1) Select time period

(2) Determined starting time (editable)

The starting time is automatically determined by the device depending on the current date (here: August 04, 2016), the current time (here: 15:00:00), and the selected time period. This time can be changed by the user.



NOTE!

The recording data that is saved in the device is organized into data blocks of 20 kB each. This may mean that even data that was recorded prior to the starting time is saved.

5 Operation

5.7 Web server

The device includes a built-in web server which supports online visualization with the help of a web browser. The user can access the process values, various visualizations, and the device's alarm and event list.

For access, you need to enter the device's IP address in the address line of the web browser. If needed, you can also use the DNS device name.

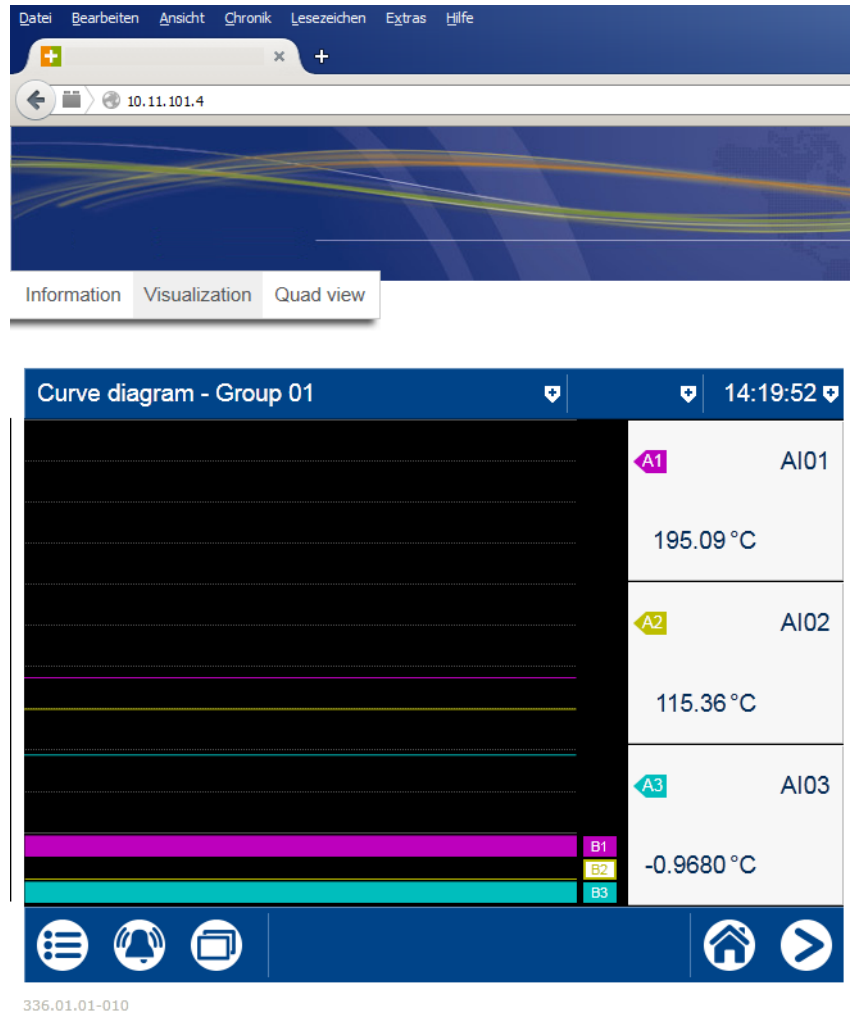

The start page, index.htm, exists by default; more HTML pages can be transferred to the device using the setup program. To prevent unauthorized access, you can activate a logon procedure with user name and password.

The web server is configured with the setup program (see the operating manual chapter "Configuration - only in setup program" > "Web server").

The web server is also activated with the setup program (see the operating manual chapter "Configuration" > "Device": Version of online visualization):



NOTE!

The display depends on the web browser used.
Supported web browsers: Microsoft Internet Explorer¹, Mozilla Firefox²

¹ Microsoft and Internet Explorer are registered trademarks of Microsoft Corporation.

² Mozilla and Firefox are registered trademarks of the Mozilla Foundation.

5.8 Electronic signature

With the extra code 888 (FDA), the user has the option to provide a completed batch or the recording data of a certain time period with their electronic signature. A logged-on user can also provide their signature during logoff – it applies to the entire time period for which the user was logged on.

The prerequisites for the electronic signature are the device-dependent settings in the PCS software as well as the related user right.

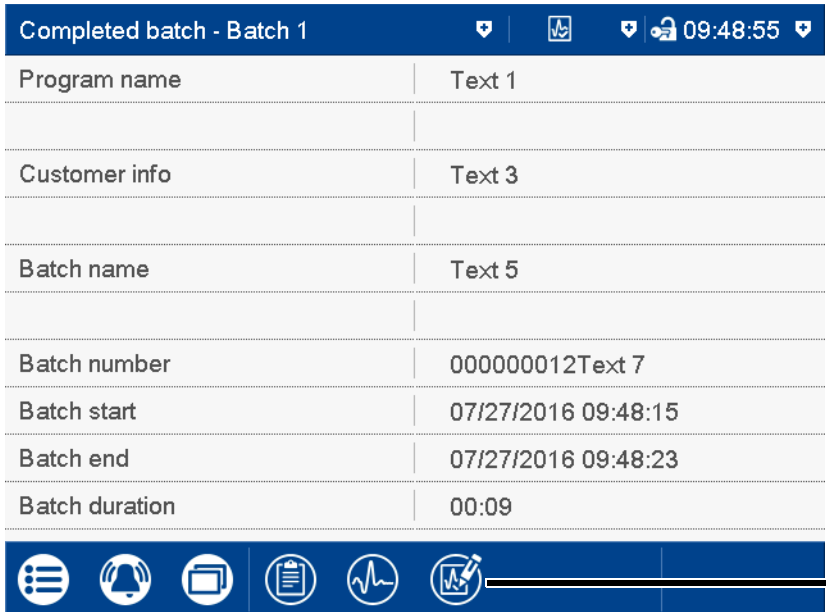

Completed batch

The following example shows the electronic signature of a completed batch.

Step	Action
1	<p>In the report of the completed batch recording, press the button (1) for the electronic signature:</p> 

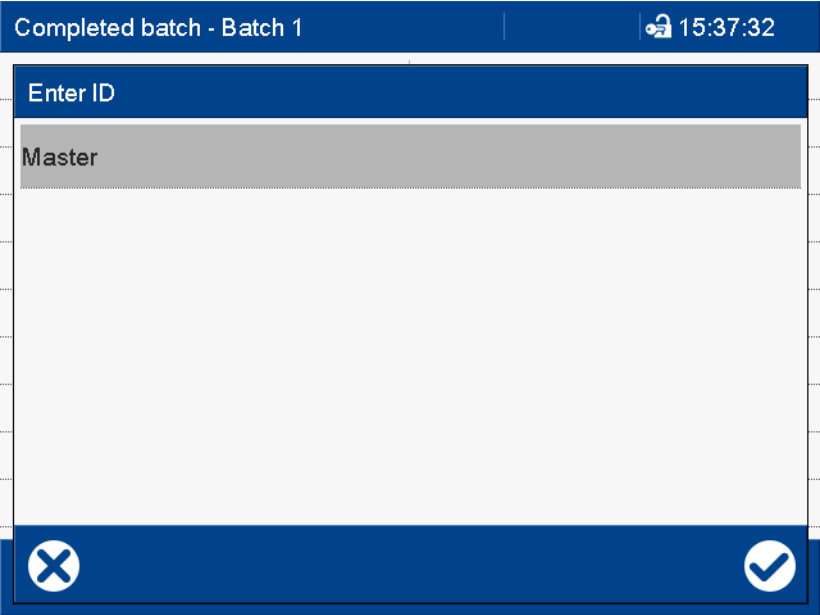
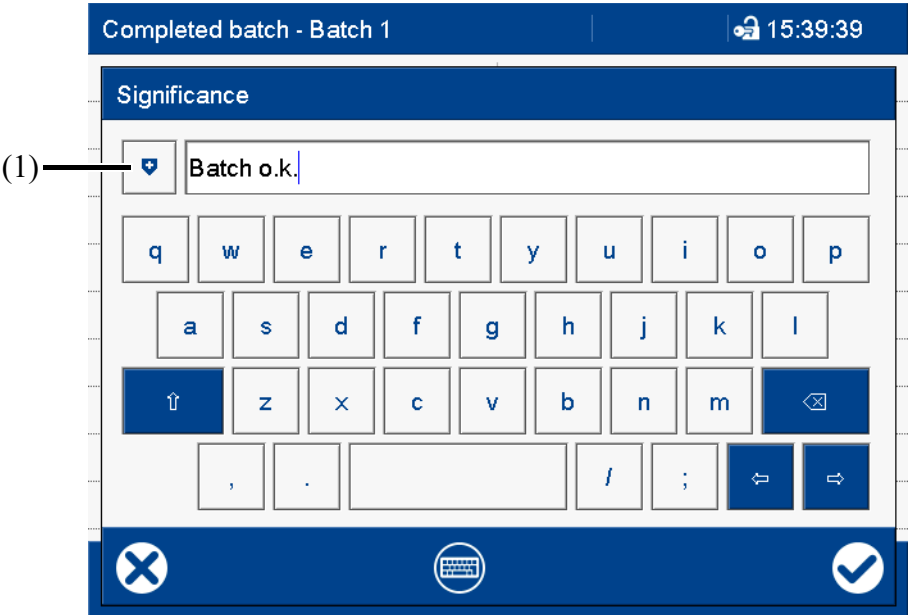
5 Operation

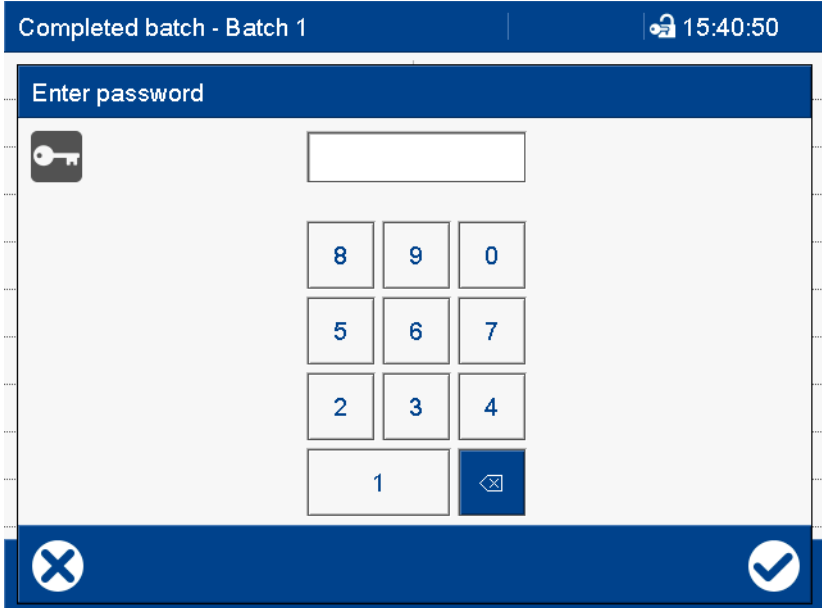
Step	Action
2	<p data-bbox="392 259 879 293">Select your user ID (in this case: master)</p> <div data-bbox="523 331 1347 943"></div> <p data-bbox="392 954 1479 1016">The user has to select his/her ID. This step is required because someone other than the currently logged-on user can provide this signature.</p>
3	<p data-bbox="392 1023 1479 1088">Enter text that describes the meaning of the signature (evaluation text) using the keyboard. Alternatively, select text from the text list (1) and, if required, edit it:</p> <div data-bbox="435 1128 1347 1740"></div> <p data-bbox="392 1751 1479 1812">The possibilities of entering a text depend on the configuration (no text available, enter text via keyboard, select text from text list, select text from text list and edit).</p>

Step	Action
4	<p data-bbox="392 259 592 286">Enter password:</p> <div data-bbox="520 331 1345 936"></div>
5	<p data-bbox="392 954 600 981">Confirm process:</p> <div data-bbox="520 1025 1345 1630"></div> <p data-bbox="392 1641 842 1668">The process can still be aborted here.</p>

5 Operation

Step	Action																																				
6	<p data-bbox="392 253 1473 320">In the report of the completed batch recording, press the button (1) to display the signature that was provided:</p> <div data-bbox="520 360 1347 976" style="border: 1px solid black; padding: 5px;"> <table border="1" style="width: 100%; border-collapse: collapse;"> <thead> <tr style="background-color: #0056b3; color: white;"> <th colspan="2" style="text-align: left;">Completed batch - Batch 1</th> <th style="text-align: right;">09:48:55</th> </tr> </thead> <tbody> <tr> <td>Program name</td> <td colspan="2">Text 1</td> </tr> <tr> <td>Customer info</td> <td colspan="2">Text 3</td> </tr> <tr> <td>Batch name</td> <td colspan="2">Text 5</td> </tr> <tr> <td>Batch number</td> <td colspan="2">000000012Text 7</td> </tr> <tr> <td>Batch start</td> <td colspan="2">07/27/2016 09:48:15</td> </tr> <tr> <td>Batch end</td> <td colspan="2">07/27/2016 09:48:23</td> </tr> <tr> <td>Batch duration</td> <td colspan="2">00:09</td> </tr> </tbody> </table> <div style="background-color: #0056b3; color: white; padding: 5px; margin-top: 5px;"> ☰ 🔔 📄 📋 📈 👤 (1) </div> </div> <p data-bbox="392 1010 1444 1077">The signature (here: master) and the meaning of the signature (here: batch o.k.) are displayed:</p> <div data-bbox="520 1122 1347 1727" style="border: 1px solid black; padding: 5px; margin-top: 10px;"> <table border="1" style="width: 100%; border-collapse: collapse;"> <thead> <tr style="background-color: #0056b3; color: white;"> <th colspan="2" style="text-align: left;">Completed batch - Batch 1</th> <th style="text-align: right;">15:43:19</th> </tr> </thead> <tbody> <tr style="background-color: #0056b3; color: white;"> <td colspan="3" style="text-align: left; padding: 5px;">Electronic signature</td> </tr> <tr> <td style="width: 50%;">Signature</td> <td colspan="2">Master</td> </tr> <tr> <td>Significance</td> <td colspan="2">Batch o. k.</td> </tr> </tbody> </table> <div style="background-color: #0056b3; color: white; padding: 5px; text-align: right; margin-top: 5px;"> ✔ </div> </div>	Completed batch - Batch 1		09:48:55	Program name	Text 1		Customer info	Text 3		Batch name	Text 5		Batch number	000000012Text 7		Batch start	07/27/2016 09:48:15		Batch end	07/27/2016 09:48:23		Batch duration	00:09		Completed batch - Batch 1		15:43:19	Electronic signature			Signature	Master		Significance	Batch o. k.	
Completed batch - Batch 1		09:48:55																																			
Program name	Text 1																																				
Customer info	Text 3																																				
Batch name	Text 5																																				
Batch number	000000012Text 7																																				
Batch start	07/27/2016 09:48:15																																				
Batch end	07/27/2016 09:48:23																																				
Batch duration	00:09																																				
Completed batch - Batch 1		15:43:19																																			
Electronic signature																																					
Signature	Master																																				
Significance	Batch o. k.																																				

Time period

The electronic signature for a time period essentially differs from the signature for the completed batch by requiring the time period in question to be selected.

The signature applies to the time period that is displayed in the diagram at the time of the signature. The displayed period may have to be expanded prior to signing. During signing the time period can only be reduced; it can then no longer be expanded.

The screenshot shows a software window titled "Group 01" with a timestamp "08/09/16 15:44:32" and a ratio "1:1". The main content area is titled "Significance" and contains the following fields:

Signature	Master -
Significance	<input type="text"/>
Time period	
from	<input type="text" value="08/09/2016 15:44:14"/>
to	<input type="text" value="08/09/2016 15:44:50"/>

At the bottom of the window, there are two circular buttons: a blue button with a white 'X' on the left and a blue button with a white checkmark on the right.

Logoff

The electronic signature during logoff requires no entry of the user ID as this function is only available for the user who is currently logged on. The further steps, including entry of the password, correspond to those of the signature for the completed batch from step 3 (enter text for meaning) to step 5 (confirm process). The signature can only be evaluated with the PCA3000 software.

The signature applies to the entire time period for which the user was logged on.

5 Operation

6.1 Technical data

6.1.1 Analog inputs

General

Number	Max. 18 (see connection diagram)
A/D converter	24 bit delta-sigma
Sampling rate	Up to 18 channels: 125 ms
Input filter	Digital filter, 2nd order; filter constant can be set from 0 to 100.0 s
Galvanic isolation	See "Galvanic isolation"

Thermocouples

Designation	Type	Standard	ITS	Measuring range	Accuracy ^a
Fe-CuNi	"L"	DIN 43710:1985-12	ITPS-68	-200 to +900 °C	≤ 0.1 %
Fe-CuNi	"J"	DIN EN 60584-1:2014	ITS-90	-210 to +1200 °C	≤ 0.1 % from -100 °C
Cu-CuNi	"U"	DIN 43710:1985-12	ITPS-68	-200 to +600 °C	≤ 0.1 % from -100 °C
Cu-CuNi DIN	"T"	DIN EN 60584-1:2014	ITS-90	-270 to +400 °C	≤ 0.1 % from -150 °C
NiCr-Ni DIN	"K"	DIN EN 60584-1:2014	ITS-90	-270 to +1372 °C	≤ 0.1 % from -80 °C
NiCr-CuNi	"E"	DIN EN 60584-1:2014	ITS-90	-270 to +1000 °C	≤ 0.1 % from -80 °C
NiCrSi-NiSi	"N"	DIN EN 60584-1:2014	ITS-90	-270 to +1300 °C	≤ 0.1 % from -80 °C
Pt10Rh-Pt	"S"	DIN EN 60584-1:2014	ITS-90	-50 to +1768 °C	≤ 0.1 % from 100 °C
Pt13Rh-Pt	"R"	DIN EN 60584-1:2014	ITS-90	-50 to +1768 °C	≤ 0.1 % from 100 °C
Pt30Rh-Pt6Rh	"B"	DIN EN 60584-1:2014	ITS-90	0 to 1820 °C	≤ 0.1 % from 600 °C
W5Re/W26Re	"C"	ASTM E230M-11	ITS-90	0 to 2315 °C	≤ 0.1 % from 500 °C
W3Re/W25Re	"D"	ASTM E1751M-09	ITS-90	0 to 2315 °C	≤ 0.1 % from 500 °C
W5Re/W20Re	"A1"	GOST R 8.585-2001	ITS-90	0 to 2500 °C	≤ 0.1 % from 500 °C
Chromel-Copel	"L"	GOST R 8.585-2001	ITS-90	-200 to +800 °C	≤ 0.1 % from -80 °C
Chromel-Alumel		GOST R 8.585-2001	ITS-90	-270 to +1372 °C	≤ 0.1 % from -80 °C
PLII (Platinel II)				0 to 1395 °C	≤ 0.1 %
Ambient temperature influence	≤ 100 ppm/K				
Smallest measuring span	Type L (Fe-CuNi), J, U, T, K, E, N, Chromel-Alumel, PLII: 100 K Type S, R, B, C, D, A1, Chromel-Copel: 500 K				
Measuring range start/end	Freely programmable within the limits, in increments of 0.1 K				
Cold junction	Internal (Pt100) or external (constant)				
Cold junction accuracy (internal)	Option with 3 analog inputs (order codes 1 and 2): ± 1 K Option with 6 analog inputs (order code 3): ± 2 K				
Cold junction temperature (external)	-30 to +85 °C (adjustable)				
Base measuring range	20 to 70 mV				

^a Accuracy refers to the maximum measuring range. Small measuring spans lead to reduced linearization accuracy.

6 Annex

RTD temperature probe

Designation	Standard	ITS	Measuring range	Accuracy ^a	Measuring current
Pt50	IEC 751:2008	ITS-90	-200 to +850 °C	≤ 0.1 %	500 μA
Pt100	IEC 751:2008	ITS-90	-200 to +850 °C	≤ 0.1 %	500 μA
Pt500	IEC 751:2008	ITS-90	-200 to +850 °C	≤ 0.1 %	100 μA
Pt1000	IEC 751:2008	ITS-90	-200 to +850 °C	≤ 0.1 %	100 μA
Pt100	JIS C 1604-1981	ITPS-68	-200 to +649 °C	≤ 0.1 %	500 μA
Pt50	GOST 6651-2009 A.2	ITS-90	-200 to +850 °C	≤ 0.1 %	500 μA
Pt100	GOST 6651-2009 A.2	ITS-90	-200 to +850 °C	≤ 0.1 %	500 μA
Cu50	GOST 6651-2009 A.3	ITS-90	-180 to +200 °C	≤ 0.4 %	500 μA
Cu100	GOST 6651-2009 A.3	ITS-90	-180 to +200 °C	≤ 0.4 %	500 μA
Ni100	DIN 43760:1987-09	ITPS-68	-60 to +250 °C	≤ 0.2 %	500 μA
Ni100	GOST 6651-2009 A.5	ITS-90	-60 to +180 °C	≤ 0.2 %	500 μA
Connection type		2/3/4-wire			
Ambient temperature influence		≤ 50 ppm/K			
Smallest measuring span		15 K			
Sensor line resistance		Max. 10 Ω per cable for two-wire circuit Max. 30 Ω per cable for three/four-wire circuit			
Measuring range start/end		Freely programmable within the limits, in increments of 0.1 K			

^a Accuracy refers to the maximum measuring range. Small measuring spans lead to reduced linearization accuracy.

Resistance transmitter and resistance/potentiometer

Designation	Measuring range	Accuracy ^a	Measuring current
Resistance transmitter	0 to 4000 Ω	≤ 0.1 %	100 μA
Resistance/potentiometer	0 to 400 Ω	≤ 0.1 %	500 μA
	0 to 4000 Ω	≤ 0.1 %	100 μA
Ambient temperature influence		≤ 100 ppm/K	
Connection type		Resistance transmitter: Three-wire circuit Resistance/potentiometer: Two/three/four-wire circuit	
Smallest measuring span		60 Ω	
Sensor line resistance		Max. 10 Ω per cable for two-wire and three-wire circuits	
Resistance values		Freely programmable within the limits, in increments of 0.1 Ω	

^a Accuracy refers to the maximum measuring range. Small measuring spans lead to reduced linearization accuracy.

Voltage, current (standard signals)

Designation	Measuring range	Accuracy ^a	Input resistance or burden voltage
Voltage	0 to 70 mV	≤ 0.1 %	> 500 kΩ
	0 to 10 V	≤ 0.05 %	> 500 kΩ
	-10 to +10 V	≤ 0.05 %	> 500 kΩ
	-1 to +1 V	≤ 0.08 %	> 500 kΩ
	0 to 1 V	≤ 0.08 %	> 500 kΩ
Current	4 to 20 mA	≤ 0.1 %	< 2 V
	0 to 20 mA	≤ 0.1 %	< 2 V
Ambient temperature influence	≤ 100 ppm/K		
Smallest measuring span			
Voltage	5 mV		
Current	0.5 mA		
Measuring range start/end			
Voltage	Freely programmable within the limits, in increments of 0.01 mV		
Current	Freely programmable within the limits, in increments of 0.01 mA		
Deviation below/above the measur. range	According to NAMUR recommendation NE 43 (only current input 4 to 20 mA)		

^a Accuracy refers to the maximum measuring range. Small measuring spans lead to reduced linearization accuracy.

Measuring circuit monitoring

The device behavior in the event of a malfunction is configurable.

Measuring probe	Probe break	Short-circuit	Polarity
Thermocouple	Is detected	Is not detected	Is detected in certain conditions ^a
RTD temperature probe	Is detected	Is detected	Is not detected
Resistance transmitter	Is detected	Is not detected	Is not detected
Resistance/potentiometer	Is detected	Is not detected	Is not detected
Voltage 0 to 70 mV	Is detected	Is not detected	Is detected
Voltage 0 to 10 V	Is not detected	Is not detected	Is detected
Voltage -10 to +10 V	Is not detected	Is not detected	Is not detected
Voltage 0 to 1 V	Is detected	Is not detected	Is detected
Voltage -1 to +1 V	Is detected	Is not detected	Is not detected
Current 0 to 20 mA	Is not detected	Is not detected	Is not detected
Current 4 to 20 mA	Is detected	Is detected	Is detected

^a Dependent on the set characteristic line

6 Annex

6.1.2 Digital inputs

Number	Max. 18 (see connection diagram)
Input	
Level	Logic level 0: < 3.5 V; logic level 1: > 10 V
Sampling rate	125 ms (max. counting frequency: 4 Hz)
Potential-free contact	R _{ON} : < 1 kΩ; R _{OFF} : > 50 kΩ (use of auxiliary voltage 24 V)
High-speed input	
Usable inputs	1, 2, 7, 8, 13, 14 (only for analog(HI)/digital option, see connection diagram)
Function	Counts each positive edge of the input signal
Max. counting frequency	12.5 kHz
Mark-to-space ratio	30 to 70 % (high-pulse ≥ 30 μs, low-pulse ≥ 30 μs)
Accuracy for flow measurement	0.5 % of measured value; ambient temperature influence: 50 ppm/K
Auxiliary voltage supply	
Voltage	DC 24 V +10/-15 %
Current	Max. 50 mA per slot (for analog (HI)/digital option: incl. digital output currents)

6.1.3 Analog outputs

Number	Max. 3 (see connection diagram)
Voltage	
Output signal	DC 0 to 10 V
Load resistance	> 500 Ω
Current	
Output signal	DC 0(4) to 20 mA
Load resistance	< 450 Ω
Accuracy	0.5 %
Ambient temperature influence	150 ppm/K

6.1.4 Digital inputs/outputs

Number	Max. 24 (see connection diagram)
Input or output	Individually configurable as input or output
Input	
Level	Logic level 0: < 3.5 V; logic level 1: > 10 V
Sampling rate	125 ms (max. counting frequency: 4 Hz)
Potential-free contact	R _{ON} : < 1 kΩ; R _{OFF} : > 50 kΩ (use of auxiliary voltage 24 V)
High-speed input	
Usable inputs	1, 2 (see connection diagram)
Function	Counts each positive edge of the input signal
Max. counting frequency	12.5 kHz
Mark-to-space ratio	30 to 70 % (high-pulse ≥ 30 μs, low-pulse ≥ 30 μs)
Accuracy for flow measurement	0.5 % of measured value; ambient temperature influence: 50 ppm/K
Output	
Output signal	DC 0/24 V +10/-15 %; galvanically isolated
Current at option	
- Analog(HI)/digital	Max. 40 mA per output, max. 50 mA in total per slot (including auxiliary voltage supply current)
- Digital	Max. 40 mA per output, max. 100 mA in total (including auxiliary voltage supply current)
Auxiliary voltage supply	
Voltage	DC 24 V +10/-15 %
Current at option	
- Analog(HI)/digital	Max. 50 mA per slot (including digital outputs current)
- Digital	Max. 100 mA (including digital outputs current)

6.1.5 Relays

Number	Max. 7 (see connection diagram)
Relay (changeover contact)	
Switching capacity	3 A at AC 230 V or DC 30 V, resistive load
Contact life	30,000 switching operations at rated load

6 Annex

6.1.6 Interfaces

RS232/RS485	
Number	1 (can be switched between RS232 and RS485)
Connector type	SUB-D 9-pin (socket)
Baud rate	9600, 19200, 38400, 115200
Data format	8/1n, 8/1e, 8/1o
Protocol	Modbus RTU as master or slave; barcode scanner
Application	Communication with Modbus master/slave, connection of a barcode scanner
External inputs	Via Modbus master/slave functionality: 120 analog and 120 digital inputs, 64 batch texts, 10 event texts
Ethernet	
Number	1 (alternative to PROFINET interface)
Connector type	RJ45 (socket)
Transfer rate	10 Mbit/s, 100 Mbit/s
Protocol	IPv4; TCP, UDP; DHCP, DNS, HTTP, SMTP, SNTP, Modbus-TCP
Application	Communication with PC (setup program, data archiving, web server), email server, SNTP server, and Modbus master/slave
External inputs	Via Modbus master/slave functionality: 120 analog and 120 digital inputs, 64 batch texts, 10 event texts
Max. cable length	100 m
PROFINET IO device	
Number	1 (alternative to Ethernet interface)
Connector type	2 x RJ45 (socket), integrated switch
Transfer rate	100 Mbit/s
Conformity class	B (CC-B)
Netload class	III (Netload Class III)
Protocol	DCP, LLDP, VLAN Priority, PTCP
Application	Communication with PROFINET IO controller; Ethernet standard services are also supported
Max. cable length	100 m
USB host	
Number	1 (on front with cover)
Connector type	A (socket)
Standard	USB 2.0 (high speed)
Application	Exclusively for connecting a USB flash drive (FAT16/FAT32; see accessories)
Max. load current	100 mA
USB device	
Number	1 (on the back)
Connector type	Micro-B (socket)
Standard	USB 2.0 (high speed)
Application	To connect to a PC (setup program, PCC/PCA3000)
Max. cable length	5 m

6.1.7 Screen

Type	TFT color screen/TFT-touchscreen (resistive) ^a
Size	14.5 cm (5.7")
Resolution	640 × 480 pixels (VGA)
Number of colors	65536
Frame rate	60 Hz (type)
Brightness setting	Adjustable on the device
Screensaver (switch-off)	After waiting period or due to control signal

^a TFT color screens may have pixel errors due to technological and/or production-related reasons. Up to four pixel errors are deemed admissible for this paperless recorder; they do not provide the ground for warranty claims.

6.1.8 Electrical data

Voltage supply	AC 110 to 240 V +10/-15 %, 48 to 63 Hz or AC/DC 20 to 30 V, 48 to 63 Hz (not in conjunction with extra code 970)
Electrical safety	According to DIN EN 61010-1 Overvoltage category II to 300 V mains voltage, pollution degree 2
Protection rating	I with internal isolation from SELV
Power consumption	
AC 110 to 240 V	< 45 VA
AC/DC 20 to 30 V	< 30 VA
Data backup	Internal flash memory
Data buffering	Battery (operating life > 7 years); additionally, storage capacitor for buffering during battery change (buffer time approx. 2 minutes)
Time	Battery-buffered real-time clock
Electrical connection	On the back via push-in spring-cage terminals
Conductor cross section on terminal 5	
Wire or stranded wire without ferrule	Min. 0.2 mm ² , max. 2.5 mm ²
Stranded wire with ferrule	Min. 0.2 mm ² , max. 2.5 mm ²
2 × stranded wire with twin ferrule with plastic collar	Min. 0.5 mm ² , max. 1.5 mm ² (both stranded wires with identical cross section)
Stripping length	10 mm
Conductor cross section on terminals 4, 24 to 29	
Wire or stranded wire without ferrule	Min. 0.2 mm ² , max. 2.5 mm ² (with terminal cover: max. 1.5 mm ²)
Stranded wire with ferrule	Min. 0.25 mm ² , max. 2.5 mm ² (with terminal cover: max. 1.5 mm ²)
Stripping length	10 mm
Conductor cross section on terminals 6 to 23	
Wire or stranded wire without ferrule	Min. 0.14 mm ² , max. 1.5 mm ² (with terminal cover: max. 0.5 mm ²)
Stranded wire with ferrule	Without plastic collar: min. 0.25 mm ² , max. 1.5 mm ² (with terminal cover: max. 0.5 mm ²) With plastic collar: min. 0.25 mm ² , max. 0.5 mm ²
Stripping length	9 mm

6 Annex

Voltage supply influence	< 0.1 % of the measuring range
--------------------------	--------------------------------

6.1.9 Environmental influences

Ambient temperature range	
Storage	-20 to +60 °C
Operation	0 to 50 °C; in conjunction with extra code 970: 0 to 40 °C
Site altitude	Max. 2000 m above sea level
Climatic environmental influences	According to DIN EN 60721-3 with extended temperature range
Resistance to climatic conditions	≤ 85 % rel. humidity without condensation
Storage	According to class 1K2
Operation	According to class 3K3
Mechanical environmental influences	According to DIN EN 60721-3
Storage	According to class 1M2
Transport	According to class 2M2
Operation	According to class 3M3
Electromagnetic compatibility (EMC)	According to DIN EN 61326-1
Interference emission	Class A – only for industrial use –
Interference immunity	Industrial requirements

6.1.10 Case

Case type	Flush-mounted housing according to DIN IEC 61554 made of zinc-plated steel sheet (indoor use)
Case front	Made of die-cast zinc with decor foil
Front frame dimensions	144 mm x 144 mm (front frame depth approx. 8 mm including seal)
Mounting depth	120.9 mm (incl. spring-cage terminals)
Panel cut-out	138 ^{+1.0} mm x 138 ^{+1.0} mm
Panel thickness	2 to 8 mm
Case fastening	In panel using the four supplied mounting elements
Operating position	Any, with due consideration for the viewing angle of the screen, horizontal ±50°, vertical ±30°
Protection type	According to DIN EN 60529, front IP65, back IP20; in conjunction with extra code 970: IP20 with open carrying case, IP20D with closed carrying case
Weight	Max. 1.75 kg (without terminal cover)

6.1.11 Approvals/approval marks

Approval mark	Testing facility	Certificate/certification number	Inspection basis	Valid for
c UL us	Underwriters Laboratories	Submitted	UL 61010-1 (3. Ed.), CAN/CSA-22.2 No. 61010-1 (3rd Ed.)	All versions of the built-in device; not in conjunction with extra code 970

6.2 Buffer battery replacement



CAUTION!

The device contains a buffer battery that is used for data buffering when the device is in switched off mode or if the power fails. The operating life of the battery is at least 7 years. A low battery is indicated by the battery pre-alarm ("Battery low"). An empty battery is indicated by the battery alarm ("Battery empty").

If the battery is not changed in time, data may be lost!

- ▶ The battery must be replaced within 4 weeks after the battery pre-alarm has been triggered. The battery change must be carried out exclusively by the manufacturer's service department. For this purpose the device must be sent to the manufacturer.

6.3 China RoHS

							
产品组别 Product group: 706530	产品中有害物质的名称及含量 China EEP Hazardous Substances Information						
部件名称 Component Name							
	铅 (Pb)	汞 (Hg)	镉 (Cd)	六价铬 (Cr(VI))	多溴联苯 (PBB)	多溴二苯醚 (PBDE)	
外壳 Housing (Gehäuse)	○	○	○	○	○	○	
过程连接 Process connection (Prozessanschluss)	○	○	○	○	○	○	
螺母 Nuts (Mutter)	○	○	○	○	○	○	
螺栓 Screw (Schraube)	○	○	○	○	○	○	

本表格依据SJ/T 11364的规定编制。
This table is prepared in accordance with the provisions SJ/T 11364.
○：表示该有害物质在该部件所有均质材料中的含量均在GB/T 26572规定的限量要求以下。
Indicate the hazardous substances in all homogeneous materials' for the part is below the limit of the GB/T 26572.

×：表示该有害物质至少在该部件的某一均质材料中的含量超出GB/T 26572规定的限量要求。
Indicate the hazardous substances in at least one homogeneous materials' of the part is exceeded the limit of the GB/T 26572.

6 Annex

6.4 Barcode

Initializing the barcode scanner

The barcode scanner must be initialized once prior to use. Example:

Step	Action
1	Scan the "Factory Default Settings" barcode.
2	Scan the "Select RS-232 Standard" barcode.

The relevant information and barcodes can be found in the manual for the barcode scanner being used.

The paperless recorder supports the barcodes code 39 (standard variant) and code 128 (A and B, without control characters) as well as the QR code (without control characters). The following examples were drawn up using code 39.

6.4.1 Batch control



NOTE!

In order to control batches using the barcode scanner, the paperless recorder must have been configured accordingly. The "Enter batch texts" right is required.

Showing the batch report

This function requires the corresponding display configuration (Configuration > Display > General: Barcode -> Batch mask = Yes).

Step	Action
1	Scan the barcode of the batch concerned (e.g. BATCH1 for batch 1).



The batch report of the selected batch is displayed.

Enter batch texts

Step	Action
1	Scan the barcodes for the batch text of the individual lines one after the other (starting with the first line).

All batch lines configured for the barcode input are populated with the scanned text one after the other (max. 160 characters). The last line is overwritten in the case of further entries.

If there is a dollar character (default setting, configurable) within the scanned text, this causes the text following the dollar character to be entered in the next line. In this way one scan operation can populate up to 10 lines. Several dollar characters stringed together cause the corresponding number of line breaks.

A maximum of 480 characters (incl. the characters for the line break) can be entered with one scan operation (e.g. 3 lines of 159 characters each or 10 lines of 47 characters each).

**NOTE!**

The batch control codes (BATCH..., START, STOP, RESET) cannot be loaded as batch texts.

Reset texts

Step	Action
1	Scan the RESET barcode.



RESET

The entered batch texts are reset. The standard texts (default texts) are displayed and the first line is prepared for text entry again.

The standard text is specified in the configuration of the batch line (Configuration > Batch > Batch line: Default text).

Start batch reporting

Step	Action
1	Scan the START barcode.



START

Batch reporting is started.

6 Annex

Stop batch reporting

Step	Action
1	Scan the STOP barcode.



STOP

Batch reporting is stopped.

In the current batch report, and depending on the configuration of the batch line, texts loaded via barcode are either reset to the standard text (default text) (Configuration > Batch > Batch line: Delete line = Yes) or retained (Delete line = No).

The texts are saved in the completed batch report.

6.4.2 Texts and process values

Specific control characters can be used to load event texts, process values (external text variables, analog and digital variables), or comment texts (batch recipes).

Once the respective text has been scanned using the control character, the system automatically switches back to barcode input for batch control.

Enter text into event list

`%En%` = entry into the event list of group n (n = number of group; $n = 0$ for all groups)

Example: `%E1%ABC`



The text "ABC" is entered into the event list of group 1.

Example: `%E0%DEF`

The text "DEF" is entered into the event lists of all groups.

Enter text into external text variable

`%Tn%` = enter as text into the external text variable n (n = number of variable)

Example: `%T1%ABC`



The text "ABC" is entered into external text variable 1.

The entered text is available in the text selector.

Control characters and the following text can also be scanned one after another. To do so, only the control character must be used for the first scan process.

Example for the first scan process: `%T1%`

The next scanned text is interpreted as text for external text variable 1.

Example for the second scan process: ABC

The text "ABC" is entered into external text variable 1.

Enter float value in external analog variable

`%Fn%` = enter as float value into external analog variable n (n = number of variable)

Example: `%F1%447.6`



The float value 447.6 is entered into external analog variable 1.

The entered value is available in the analog selector.

6 Annex

Enter binary value in external digital variable:

`%Bn%` = enter as binary value into external digital variable n (n = number of variable)

Example: `%B1%1`



`%B 1 %1`

The binary value 1 is entered into external digital variable 1.

The entered value is available in the digital selector.

A scan process allows several values in consecutive variables to be entered.

Example: `%B2%101`

The binary values 1, 0, 1 are entered as from variable 2 (variable 2 = 1, variable 3 = 0, variable 4 = 1).

Enter text (recipe) in batch report

`%Rn%` = enter as comment text (e.g. recipe) into the batch report of batch n (n = number of batch)

Example: `%R1%ABC`



`%R 1 %A B C`

The text "ABC" is entered as comment text into the batch report of batch 1.

The comment text can contain up to 400 characters (20 lines with 20 characters each); it is used to describe the batch. It can only be displayed using the PC evaluation software PCA3000.



JUMO GmbH & Co. KG

Street address:
Moritz-Juchheim-Straße 1
36039 Fulda, Germany

Delivery address:
Mackenrodtstraße 14
36039 Fulda, Germany

Postal address:
36035 Fulda, Germany

Phone: +49 661 6003-0
Fax: +49 661 6003-607
Email: mail@jumo.net
Internet: www.jumo.net

JUMO Instrument Co. Ltd.

JUMO House
Temple Bank, Riverway
Harlow, Essex, CM20 2DY, UK

Phone: +44 1279 63 55 33
Fax: +44 1279 62 50 29
Email: sales@jumo.co.uk
Internet: www.jumo.co.uk

JUMO Process Control, Inc.

6733 Myers Road
East Syracuse, NY 13057, USA

Phone: +1 315 437 5866
Fax: +1 315 437 5860
Email: info.us@jumo.net
Internet: www.jumousa.com

