

SPOT

MOUNTINGS
AND ACCESSORIES

A PRODUCT OF THE SYSTEM 5 FAMILY

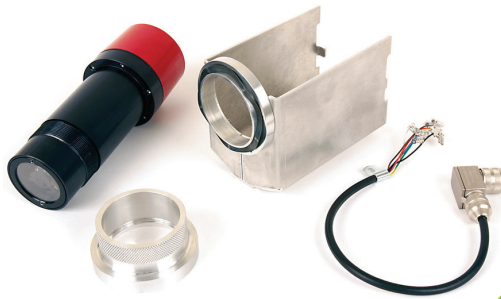

i FOR STANDARD BODY AND FIBER-OPTIC VARIANTS



LAND
AMETEK[®]
PROCESS & ANALYTICAL INSTRUMENTS



QUALITY CUSTOMER SOLUTIONS

SPOT

MOUNTINGS & ACCESSORIES

AMETEK LAND HAS BEEN MANUFACTURING PRECISION MEASURING EQUIPMENT SINCE 1947.

WE ARE SPECIALISTS IN NON-CONTACT TEMPERATURE MEASUREMENT AND COMBUSTION MONITORING WITH APPLICATIONS ACROSS DIVERSE INDUSTRIES SUCH AS STEEL AND GLASS MAKING, POWER GENERATION AND CEMENT MANUFACTURE.

As part of AMETEK Process & Analytical Instruments Division since 2006, our customers benefit from the worldwide AMETEK sales and service team.

The following information is intended as a guide to the range of optional mountings and accessories available to ensure you get the best possible service from the investment you have made when specifying SPOT pyrometers for your application solution.

For specific recommendations on the choice of mountings, brackets, cables, or any other accessories, that may suit your specific industry or installation, please contact an AMETEK Land sales manager or representative for further advice before ordering.

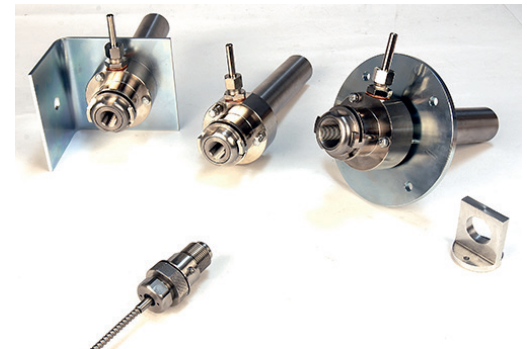

SOFTWARE ▼

SPOTVIEWER

Specifically developed to work seamlessly with the latest generation of industry leading single point thermometers. SPOT Viewer's simple installation means that the operator can quickly connect, configure and view data from any of AMETEK Land's SPOT range of pyrometers.

Easy view and analysis of long term data displayed in both graphical and tabular views. Clearly highlights trends and patterns allowing the user a greater understanding of the temperatures involved in their process.

Simple configuration of thermometer settings from a remote location giving the operator total control over temperature measurement on their process without the need to be at the instrument location.

For full details see our SPOT Viewer Brochure.

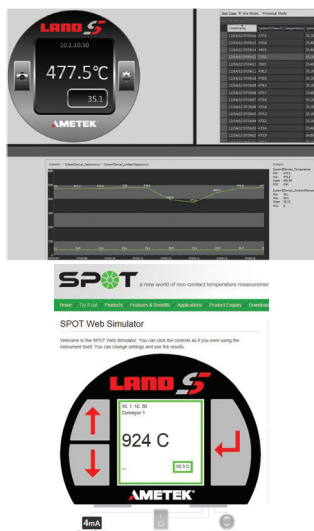

THE INSTRUMENT VIEW

A graphical representation of the SPOT pyrometer control panel. Temperature values are displayed and the menu system can be accessed here. This view also allows you to take a snapshot image of the target being viewed by the pyrometer on the lensed variants.

THE GRID VIEW

A data-logger view of temperature readings in date/time order

THE TREND VIEW

Gives a graphical trace of temperature readings, also in date/time order

THE MENU BAR

Provides access to additional options such as data-logger and User Management

THE STATUS BAR

Shows an overview of the system connections and displays error messages in the event of a fault.

PART NUMBERS:
SPOTVIEWER USER PACK
808279
SPOT SDK USER PACK
808299



TYPICAL APPLICATION - BLAST FURNACE ▲



SPOT MOUNTINGS & ACCESSORIES

FIBER OPTIC MOUNTINGS

QUICK RELEASE PURGE ASSEMBLY

The purge assembly features a quick release mount and short Inconel sighting tube. The air purge is used where a clear sight path has to be maintained, by using the purging air to maintain the lens free from dust, dirt, etc. The purge connects to the optic head with a quick release adapter (supplied) which allows rapid, no tools removal of the optic head for routine maintenance. The purge is secured on the installation using either a mounting adapter or plate.

PART NUMBER: 029.870

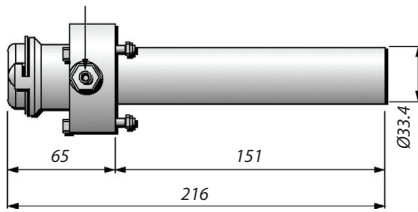

QUICK RELEASE PURGE & ADJUSTABLE MOUNTING FLANGE

The adapter, air purge and mounting plate assembly attaches to the optic head, and provides a mounting using the four holes through the circular plate. The quick-release adapter which forms an integral part of this assembly allows rapid, no tools removal of the optic head for routine maintenance.

PART NUMBER: 029.871

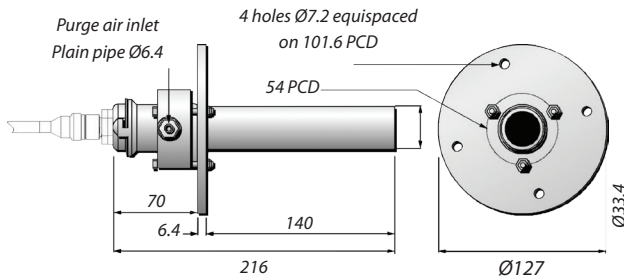

FIBER OPTIC ADAPTER

The fiber-optic adapter enables the optic-head to be mounted as a stand-alone, in applications which require no purging, protection or special mounting considerations. A single 1/4 in. thread bolt hole can attach to the Small Ball Mounting or a standard tripod mounting. Two further holes in the base permit mounting to a flat surface.

PART NUMBER: 809901

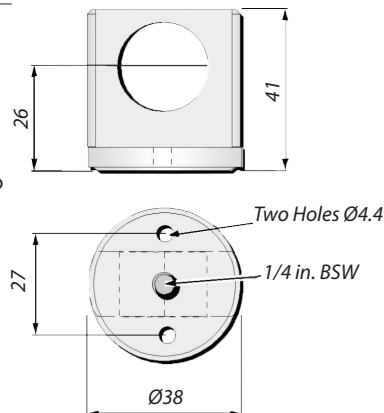

QUICK RELEASE PURGE & MOUNTING PLATE

The adapter, air purge and adjustable mounting flange assembly attaches to the optic head, and provides a mounting using the four holes through the circular plate. Three studs link the main plate to a smaller plate providing adjustment to ensure accurate alignment to the target surface. The quick-release adapter which forms an integral part of this assembly allows rapid, no tools removal of the optic head for routine maintenance.

PART NUMBER: 029.872

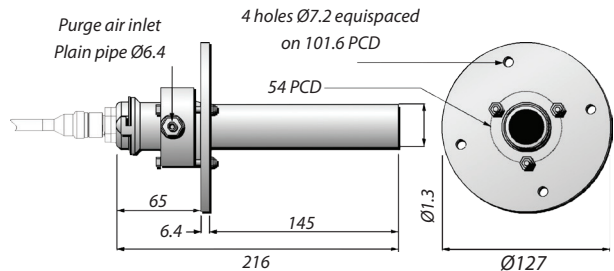

QUICK RELEASE PURGE & ANGLE MOUNTING BRACKET

The adapter, air purge and mounting bracket assembly attaches to the optic head, and provides mounting using the single hole in the base of the bracket. Alternatively, the bracket will attach to the large ball-mounting (S4 LB) to provide adjustment to ensure accurate alignment on to the target surface; particularly useful when sighting onto a small target. The quick-release adapter which forms an integral part of this assembly allows rapid, no tools removal of the optic head for routine maintenance.

PART NUMBER: 029.873

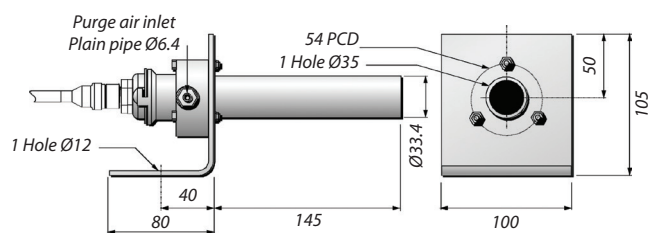

SMALL BALL MOUNT

The small ball mount can be used with the fiber-optic adapter (809901). It can be used with any standard tripod or using a 1/4" UNC bolt to a surface.

PART NUMBER: 150.560

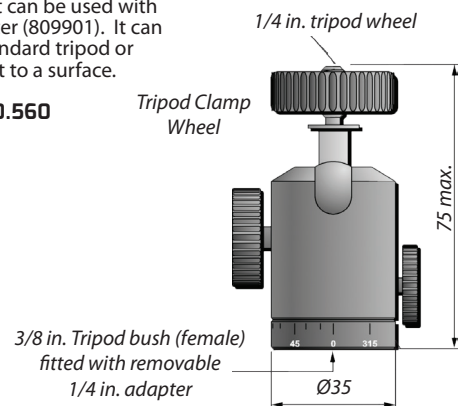

SIGHTING TUBES

Sighting tubes are made from metal or refractory materials and are either open ended (Type STO) or closed (Type STC).

Type STO tubes are used when viewing a solid target through flame, smoke, fumes etc. The closed end of the type STC tube is used as the target. A thermometer used with an STC tube can replace a sheathed thermocouple.

To attach the sighting tubes to a mounting plate a steel adapter (Type STA) is cemented into the refractory sighting tubes. The STA is drilled to fit the studs on the mounting plate (PN 095.091). Replacement Sighting Tubes can be purchased without the STA adapter fitted. Contact Land for details.

There are 3 types of tube material with various lengths. For exact dimensions and ordering references please refer to the table adjacent.

Silicon Carbide Tubes (STO & STC)

These are either open ended or closed, and can be used in temperatures up to 1500°C. They have high mechanical strength, good resistance to thermal shock and very high thermal conductivity.

Sillimanite Tubes (STO only)

These are suitable for use in temperatures up to 1550°C and are fairly resistant to thermal shock. Sillimanite liner tubes are also available.

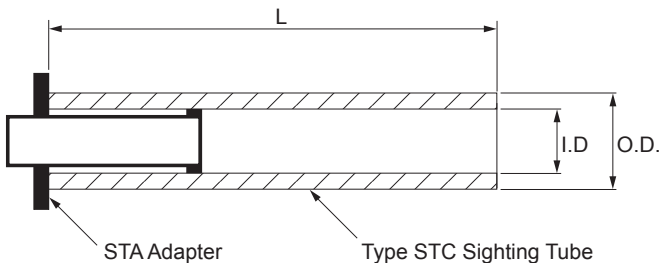
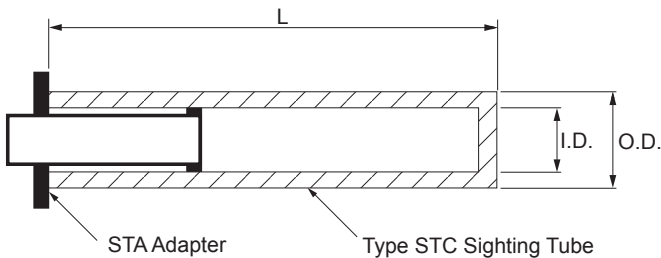

Stainless Steel Tubes

A low temperature tube for use up to a maximum of 800°C. The exact temperature will depend upon length and operating conditions. Used mainly to protect the thermometer window from physical damage and to direct purge air along the sight path. Stainless Steel sighting tubes come complete with own type F adapter.

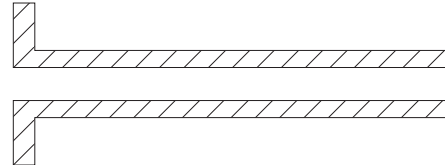

Sighting Tube Information

Type	Dimensions in			Adapter Type	Part No
	L	OD	ID		
Silicon Carbide STC	450	76	64	STA	091.410
	600	76	64	STA	091.411
	750	76	64	STA	091.412
	900	76	64	STA	091.413
	1050	76	64	STA	091.414
Silicon Carbide STO	450	76	64	STA	091.415
	600	76	64	STA	091.416
	750	76	64	STA	091.417
	900	76	64	STA	091.418
	1050	76	64	STA	091.419
Sillimanite STO	600	70	2.4	STA	091.420
	750	70	2.4	STA	091.421
	900	70	2.4	STA	091.422
	1050	70	2.4	STA	091.423
	1200	70	2.4	STA	091.424
Sillimanite liner tubes	355	95	3.2	-	118.270
	510	95	3.2	-	118.271
Stainless Steel	150	57	54	F	091.458
	910	57	54	F	N/S

Dimensions on drawings are in mm.

SPOT MOUNTINGS & ACCESSORIES

AMETEK LAND OFFERS A RANGE OF SPOT FIXED SINGLE POINT PYROMETERS.

Designed to operate flawlessly in most demanding industrial environments, the SPOT range is perfect for applications across many industries including iron and steel, glass, metal forging, heat treatment, cement, and many more.

The various models in the SPOT pyrometer range are available in temperatures between 250-1800 °C / 482-3272 °F.

SPOT Fixed pyrometers are part of the System 5 family of products, continuing AMETEK Land's fine history in industrial non-contact temperature measurement. Featuring both single wavelength and multi-mode instruments all available in lensed and fiber-optic versions.

The SPOT range are high technology radiation pyrometers designed to produce the most accurate temperature measurements for numerous industrial manufacturing applications. SPOT includes many innovative technologies to simplify setup and use, reduce installation and operational costs together with ensuring high accuracy and long life. Adaptors exist to enable SPOT sensors to be easily retrofitted into Land System 4 and UNO mountings.



MOUNTINGS

MOUNTING BRACKET & LOCK NUT

The Mounting Bracket forms the basis of the Light Purge, but can be used on its own where there is no requirement for a purge air supply to keep the pyrometer lens clean. It is straightforward to install, and has a hole for mounting on a tripod. It can also be fitted to ball mount allowing 360° rotation for precision alignment.

PART NUMBER: 808468



SEALED TO PROCESS WATER COOLED MOUNTING

The Mounting includes a Protection Window which separates the process from the pyrometer, enabling safe removal of the pyrometer from its jacket at any time.

Note: The Sapphire Protection Window has an effect on the signal strength, due to transmission losses. By specifying the process window in the instrument software, it will automatically correct for the transmission loss. (Shown with optional small pan and tilt bracket)

PART NUMBER: 808862

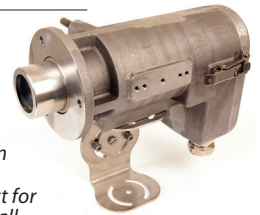

WATER COOLED MOUNTING

This incorporates the integrated Protection Jacket and Purge plus the hinged back cap. (Shown with optional small pan and tilt bracket)

PART NUMBER: 808100

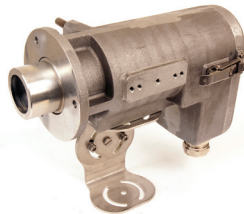

SEALED TO PROCESS UPGRADE KIT

This kit includes all parts necessary to upgrade the Water cooled mounting into the sealed to process version.

PART NUMBER: 808336

MOUNTING PLATE

The Mounting Plate has four process attachment holes and three studs for the jacket. This is an optional interface between the process and the front flange of the water cooled mounting.

PART NUMBER: 095.091



ADJUSTABLE MOUNTING PLATE

The mounting plate has four process attachment holes and three studs to attach the water cooled mounting. This is easily adjustable to allow precise alignment with the target.

PART NUMBER: 095.168

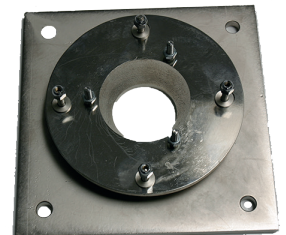



LIGHT PURGE

The Light Purge is designed to keep the pyrometer lens clean, when installed in less-hostile environments such as light industry or research. Supplied with mounting bracket and lock nut as standard.

PART NUMBER: 808015

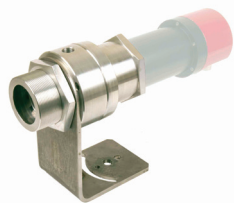

SMALL PAN & TILT BRACKET

This dual axis mounting bracket can be used with the water cooled mounting where the mounting front flange is inappropriate.

PART NUMBER: 806761



SYSTEM 4 ADAPTER KIT

The System 4 to SPOT Adapter Kit allows you to install a Land SPOT Pyrometer in an S4-J. This means that you can replace an existing System 4 Pyrometer with a Land SPOT pyrometer without having to replace any existing pyrometer protection jackets or mountings. The System 4 to SPOT Adapter Kit consists of an Adapter Sleeve, a Lock Ring and a Replacement Cable Assembly.

PART NUMBER: 808018

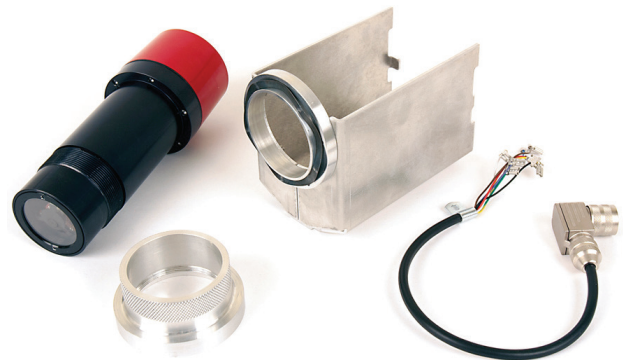

CABLES

DIGITAL CABLES

Digital Power Cable - A specific length cable with an M12PoE connector, the other end a RJ45 fitting for a network control switch or Control PC.

PART NUMBERS:
 5m M12-RJ45 cable 807944
 20m M12-RJ45 cable 807945
 100m M12-RJ45 cable 807946



ANALOG CABLES

Eight conductor analog connector cable one end terminated to an 8-way SPOT connector, the other end stripped flying leads.

PART NUMBERS:
 M16-Free 8 Way Cable 807950
 M16-Free 8 Way Cable 807951
 M16-Free 8 Way Cable 807952



SPOT

MOUNTINGS AND ACCESSORIES

PART NAME	PART NUMBER
SOFTWARE	
SPOTViewer User Pack	808279
SPOT SDK User Pack	808299
MOUNTINGS	
Mounting Bracket and Lock Nut	808468
Water Cooled Mounting	808100
Pan and Tilt Bracket	806761
Sealed to Process Water Cooled Mounting	808862
Sealed to Process Upgrade Kit	808336
Light Purge	808015
System 4 Adapter Kit	808018
Mounting Plate	095.091
Adjustable Mounting Plate	095.168
CABLES	
Digital	
5m M12-RJ45 Cable with straight connector	807944
20m M12-RJ45 Cable with straight connector	807945
100m M12-RJ45 Cable with straight connector	807946
Analog	
M16-Free 8 Way Cable 5 m Str Connector	807950
M16-Free 8 Way Cable 20 m Str Connector	807951
M16-Free 8 Way Cable 100 m Str Connector	807952
Analog connection PCB/kit	807942s
FIBER OPTIC MOUNTINGS	
Quick Release Purge Assembly	029.870
Quick Release Purge and Adjustable Mounting Flange	029.871
Quick Release Purge and Mounting Plate	029.872
Quick Release Purge and Angle Mounting Bracket	029.873
Small Ball Mount	150.560
Fiber Optic Adaptor	809901

SEE OUR OTHER LITERATURE FOR THE SPOT R100 AND SPOT MOUNTINGS AND ACCESSORIES:



SPOT FAMILY OF PYROMETERS



SPOTVIEWER/SPOTPRO SOFTWARE

DISCOVER HOW OUR BROAD RANGE OF NON-CONTACT TEMPERATURE MEASUREMENT AND COMBUSTION & EMISSIONS PRODUCTS OFFER A SOLUTION FOR YOUR PROCESS

WWW.AMETEK-LAND.COM

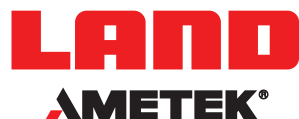

CONTACT US



www.ametek-land.com



land.enquiry@ametec.com



Certificate No. CC-2041
APPLIES IN INDIA



APPLIES IN THE UK



APPLIES IN THE US