

FP23 Series Programmable Controller

Instruction Manual

1-input

Thank you for purchasing the Shimaden FP23 Series Programmable Controller. Check that the delivered product is the correct item you ordered. Do not begin operating this product until you have read and thoroughly understood the contents of this Instruction Manual.

SHIMADEN CO., LTD.

MFP023-E01-B
Jan, 2006

Request

Make sure that this instruction manual is given to the final user of the device.
Keep this manual at the work site during operation of the FP23 Series.

Preface

This Instruction Manual describes the basic functions and how to use "1-input: 1-output/2-output" FP23 Series Controllers.
For details on "2-input: 1-output/2-output" and "servo output," refer to separate manuals.

This Instruction Manual is meant for those will be involved in the wiring, installation, operation and routine maintenance of the FP23 Series. This manual describes the handling, installation and wiring procedures for operation.

While using this device, you should always follow the instructions written in this manual.

For safety precautions and potential damage to equipment and/or facilities, additional instructions are indicated by the following headings.

Safety Precautions



Warning

The FP23 Series Digital Controller is designed for controlling temperature, humidity and other physical quantities in general industrial facilities. It must not be used in any way that may adversely affect the safety, health or working conditions of those who come into contact with the effects of its use. When used, adequate and effective safety countermeasures must be provided at all times by the user. No warranty, express or implied, is valid when this device is used without the proper safety countermeasures.



Warning

- ◆ Before you start to use this device, install it in a control panel or the like and avoid touching the terminals.
 - ◆ Do not open this device's case, and touch the boards or inside of the case with your hands or a conductor. The user should never repair or modify this device. Doing so might cause an accident that may result in death or serious bodily injury from electric shock.
-
-



Caution

To avoid damage to connected peripheral devices, facilities or the product itself due to malfunction of this device, safety countermeasures such as proper installation of the fuse or installation of overheating protection must be taken before use. No warranty, express or implied, is valid in the case of use resulting in an accident without having taken the proper safety countermeasures.

- ◆ The warning mark on the plate affixed on the casing of this device warns you not to touch charged parts while this device is powered ON. Doing so might cause an electric shock.
- ◆ A means for turning the power OFF such as switch or a breaker must be installed on the external power circuit connected to the power terminal on this device. Fasten the switch or breaker at a position where it can be easily operated by the operator, and indicate that it is a means for powering this device OFF.
- ◆ This device does not have a built-in fuse. Install a fuse that conforms to the following rating in the power circuit connected to the power terminal.

Fuse rating/characteristics: 250 VAC 1.0A/medium lagged or lagged type

- ◆ When wiring this device, tighten the terminal connections firmly.
 - ◆ Use the device with the power voltage and frequency within their rated ranges.
 - ◆ Do not apply a voltage or current outside of the input rating to the input terminal. Doing so might shorten the service life of this device or cause it to malfunction.
 - ◆ The voltage and current of the load connected to the output terminal should be within the rated range. Exceeding this range may cause the temperature to rise which might shorten the service life of this device or cause it to malfunction.
 - ◆ This device is provided with ventilation holes for heat to escape. Prevent metal objects or other foreign matter from entering these ventilation holes as this may cause this device to malfunction. Do not block these ventilation holes or allow dirt and dust to stick to these holes. Temperature buildup or insulation failure might shorten the service life of this device or cause it to malfunction.
 - ◆ Repeated tolerance tests on voltage, noise, surge, etc. may cause this device to deteriorate.
 - ◆ Never remodel this device or use it a prohibited manner.
 - ◆ To ensure safe and proper use of this device, and to maintain its reliability, observe the precautions described in this manual.
 - ◆ Do not operate the keys on the front panel of this device with a hard or sharp-tipped object. Be sure to operate the keys with your fingertips.
 - ◆ When cleaning this device, do not use paint thinner or other solvents. Wipe gently with a soft, dry cloth.
-

Check before use

This device has been fully checked for quality assurance before shipment from the factory. However, you are requested to make sure that there are no errors, damages or shortages in the delivered items by confirming the model code, external appearance of the device and the number of accessories.

Confirmation of model codes

Referring to the table below check the model codes affixed to the case of the product to check if the respective codes indicate what was specified when you ordered the product.

Checking accessories

Make sure that your product package has all of the following items

Standard accessories

- (1) Quick Reference
- (2) Support CD
- (3) Mounting fixture (w/ 2 screws)
- (4) Terminal cover
- (5) Unit decal

Optional accessories

- (1) Current transformer (CT) for heater break alarm (when the heater break alarm option is selected)
- (2) Terminal resistor (when the RS-485 communication option is selected)

Options (sold separately)

The following table shows the options available for this product.

Model Name	Model No.	Specification
Infrared Communication Adapter	S5004	USB 1.1
Shunt resistor	QCS002	250Ω±0.1%
Relay Unit	AP2MC	Converts open collector output to 2-point contact.

■ 1-input specification

Item	Code	Specification	
1. Series	FP23-	Multi-function programmable controller, DIN 96 x 96 mm	
2. Basic functions	SS	Universal-input, 1-input/1-output control, 3 event outputs	
	SD	Universal-input, 1-input/2-output control, 3 event outputs	
3. Control Output 1	Y	Contact 1c, Contact rating: 240 V AC, 2.5 A/resistive load, 1A/ inductive load	
	I	Current 4 to 20 mA DC, Load resistance: 600Ω max.	
	P	SSR drive voltage 12 V±1.5 V DC, Load current: 30 mA max.	
	V	Voltage 0 to 10 V DC, Load current: 2 mA max.	
4. Control Output 2 N- selected when basic function SS is used	N-	None	
	Y-	Contact 1c, Contact rating: 240 V AC 2.5 A/resistive load, 1A/ inductive load	
	I-	Current 4 to 20 mA DC, Load resistance: 600Ω max.	
	P-	SSR drive voltage 12 V±1.5 V DC, Load current: 30 mA max.	
	V-	Voltage 0 to 10 V DC, Load current: 2 mA max.	
5. Heater Break alarm (for single phase) *1	00	None	
	31	Heater Break alarm (heater Current 30 A, CT provided)	Selectable only when Control Output 1 or 2 is Y or P
	32	Heater Break alarm (heater current 50 A, CT provided)	
6. Analog Output 1	0	Without	
	3	0 to 10 mV DC, Output resistance: 10Ω	
	4	4 to 20 mA DC, Load resistance: 300Ω max.	
	6	0 to 10 V DC, Load current: 2 mA max.	
7. Analog Output 2/sensor power supply	0	Without	
	3	0 to 10 mV DC, Output resistance: 10Ω	
	4	4 to 20 mA DC, Load resistance: 300Ω max.	
	6	0 to 10 V DC, Load current: 2 mA max.	
	8	Sensor power supply 24 V DC 25mA	
8. External I/O control signals (DI/DO) *2	Standard	0	4 DI, 5 DO
		1	10 DI, 9 DO
		2	10 DI, 13 DO
9. Communication interface	0	Without	
	3	RS-485 (not insulated)	SHIMADEN protocol/ MODBUS communication protocol
	5	RS-485	
	7	RS-232C	
10. Remarks	0	Without	
	9	With	

*1 When the 2-output specification is used, either of Control Output 1 or Control Output 2 is used as the heater break alarm.

*2 Ten DI points (code 1 or 2) are required for switching the start pattern No. by DI.

Contents

1	INSTALLATION & WIRING	1
1-1	Installation Site	1
1-2	External Dimensions and Panel Cutout	1
1-3	Mounting	2
1-4	Current Transformer (CT) for Heater Break Alarm.....	3
1-5	Rear Terminal Arrangement Diagram.....	4
1-6	Wiring	6
2	NAMES & FUNCTIONS OF PARTS ON FRONT PANEL.....	7
3	BASIC OPERATIONS.....	11
3-1	Power ON.....	11
3-2	Switching LCD Screen Display and Moving the Cursor.....	12
(1)	Switching the screen display.....	12
3-3	Changing and Registering Data.....	13
(1)	Entering numerical values.....	13
(2)	Selecting setup items.....	14
4	CONTROL MODES & FUNCTION BLOCKS	15
4-1	Control Modes	15
4-2	Reset State	15
4-3	Program Functions	16
4-4	CONTROL FUNCTION BLOCK DIAGRAMS	18
(1)	1-input, 1-output/2-output.....	18
5	SETUP	19
5-1	Parameter Setup Procedure	19
6	OUTPUT SPECIFICATION & KEY LOCK.....	21
6-1	Confirming the Output Specification	21
6-2	Releasing the Key Lock.....	22
(1)	Key lock screen display	22
(2)	Releasing the key lock.....	22
7	I/O SETTINGS, INFRARED COMMUNICATION	23
7-1	Output Specifications (2-output specification).....	23

7-2	Infrared Communication	23
7-3	Measuring Range	24
(1)	Range setting	24
(2)	Range scaling.....	25
7-4	Unit.....	28
7-5	Decimal Point Position.....	29
(1)	Decimal point position	29
(2)	Switching the lowest digit past the decimal point	29
7-6	Cold Junction Compensation.....	30
(1)	Thermocouple cold junction compensation	30
8	I/O AUXILIARY SETTINGS.....	31
8-1	PV Compensation Value.....	31
(1)	PV bias	31
(2)	PV filter.....	31
(3)	PV slope.....	31
8-2	Square Root Extraction Operation.....	32
(1)	Enabling the square root extraction operation.....	32
(2)	Low cut.....	32
8-3	Control Output	33
(1)	Action characteristics	33
(2)	Output at reset.....	33
(3)	Output at error	34
(4)	Proportional cycle time	34
(5)	Setting output 2	34
8-4	Setting the Ten-Segment Linearizer Approximation	35
(1)	Enabling ten-segment linearizer approximation	35
(2)	Setting input points.....	35
8-5	Limiters	37
(1)	Output rate-of-change limiter.....	37
(2)	SV limiter	37
8-6	Compensating Control Output/Analog Output	38
9	PROGRAM SETTINGS.....	39
9-1	Program Initial Settings	39
(1)	Time unit.....	39
(2)	Program start delay time	39
(3)	Input error mode.....	39
(4)	Power failure compensation.....	40
(5)	Advance mode	40
(6)	Advance time.....	40

9-2	Step-related Settings	41
(1)	Step SV value	41
(2)	Step Time.....	41
(3)	Step PID No.....	41
9-3	Pattern-related Settings	42
(1)	Number of steps.....	42
(2)	Start step	42
(3)	Start SV	42
(4)	Pattern execution count	43
(5)	Start step No. of step loop	43
(6)	End step No. of step loop.....	43
(7)	Execution count of step loop.....	44
(8)	Guarantee soak zone.....	44
(9)	Guarantee soak time.....	45
(10)	PV start	45
9-4	Pattern Link-related Settings	47
(1)	Setting the pattern link execution count.....	47
(2)	Pattern link.....	47
9-5	Settings Before Program Operation.....	48
(1)	Auto-tuning point.....	48
(2)	Program EVENT/DO action points.....	49
(3)	Time signal (TS).....	50
(4)	Start pattern No.....	52
10	FIX SETTINGS.....	53
10-1	Switching the FIX Mode.....	53
10-2	FIX SV Value	53
10-3	FIX PID No.	54
10-4	FIX MOVE	54
10-5	FIX EVENT/DO Action Points.....	55
11	PID SETTING.....	57
11-1	Proportional Band (P)	57
11-2	Integral Time (I)	57
11-3	Derivative Time (D).....	58
11-4	Manual Reset (MR).....	58
11-5	Action Hysteresis (DF).....	59
11-6	Dead Band (DB)	59
11-7	Set Value Function (SF)	61
11-8	Output Limit Value (OUT1L to OUT2H)	62

11-9	Zone PID	63
(1)	Selecting Zone PID	64
(2)	Zone hysteresis	64
(3)	PID zone value	64
12	EVENT & DO SETTING	65
12-1	Monitor Screens	65
(1)	DO monitor	65
(2)	Logic monitor	65
12-2	EVENT/DO Action	65
(1)	Output characteristics.....	67
(2)	Hysteresis.....	67
(3)	Delay time	68
(4)	Inhibit Action.....	68
12-3	Event Logic Operations	69
(1)	Logic operation mode (Log MD).....	69
(2)	Assigning logic operation input (SRC1, SRC2).....	70
(3)	Logic operation input logic (Gate1, Gate2).....	70
12-4	Timers/Counters	71
(1)	Timer time	71
(2)	Counter.....	71
(3)	Assigning input (SRC).....	71
(4)	Mode (Log MD)	72
13	OPTION (HB, COM, DI, AO) SETTINGS	73
13-1	Setting the Heater Break/Heater Loop Alarms.....	73
(1)	Connecting the Current Transformer (CT)	73
(2)	Heater current monitor	73
(3)	Heater Break Alarm current (HBA).....	74
(4)	Heater Loop Alarm current (HLA).....	74
(5)	Heater Break/Heater Loop Alarm mode (HBM).....	74
(6)	Heater Break detection Selection (HB)	75
13-2	Communication.....	76
(1)	Setting communication	76
(2)	Communication Mode (COM).....	77
13-3	DI.....	78
(1)	DI monitor screen	78
(2)	Selecting DI Action	78
13-4	Analog Output.....	81
(1)	Analog Output type.....	81
(2)	Scaling Analog Output.....	81

14	KEY LOCK SETTING.....	83
14-1	Setting Key Lock.....	83
(1)	Displaying the key lock screen.....	83
(2)	Key lock	83
15	MONITORING, EXECUTING & STOPPING OPERATION.....	85
15-1	Operations in Basic Screen	85
(1)	Setting the start pattern.....	85
(2)	Setting the start step.....	85
(3)	Setting the FIX mode	86
(4)	Setting the FIX SV value (only in FIX mode)	86
15-2	Displaying the Step No. and SV	87
15-3	How to Start / Stop Control	87
16	OPERATIONS DURING CONTROL.....	89
16-1	Monitoring Control	89
(1)	Basic screen	89
(2)	Output value display	89
(3)	Monitoring program status	89
(4)	Monitoring the remaining step time.....	90
(5)	Monitoring the program.....	90
(6)	Monitoring the pattern link.....	90
(7)	Monitoring information during control execution	90
16-2	Executing and Stopping Auto Tuning.....	91
16-3	Switching Auto/Manual of Control Output.....	93
(1)	Manual output operations	93
(2)	Simple key-based manual output operations.....	94
16-4	Temporarily Holding (HLD) and Resuming Program Execution.....	95
16-5	Executing Advance (ADV)	96
17	ERROR DISPLAYS.....	99
17-1	Operation Check Abnormalities at Power ON.....	99
17-2	PV Input Abnormalities	100
17-3	Heater Current Abnormalities (option)	100
18	LIST OF PARAMETERS	101
18-1	Execution Screen Group (group 1)	101
18-2	Program Screen Group (group 2)	102
18-3	Step Screen Group (group 2S).....	103
18-4	PID Screen Group (group 3).....	104
18-5	EVENT/DO Screen Group (group 4).....	105

18-6	DI/Option Screen Group (group 5).....	107
18-7	Control Output Screen Group (group 6)	110
18-8	Unit/Range Screen Group (group 7).....	111
18-9	Lock, etc. Screen Group (group 8)	112
19	PARAMETER SETUP RECORD SHEETS	113
19-1	Product Model Code.....	113
19-2	CTRL EXEC Parameters.....	113
19-3	PROG STEP Parameters	114
19-4	PID Parameters	116
19-5	EVENT/DO Parameters.....	117
19-6	DI/Options Parameters	118
19-7	Control Output Parameters.....	118
19-8	Unit/Measuring Range Parameters	118
19-9	Lock, etc. Parameters.....	119
20	SPECIFICATIONS	121
20-1	Display.....	121
20-2	Settings	121
20-3	Input	122
20-4	Control	123
20-5	Program Function	124
20-6	Event Output.....	125
20-7	External Control Output (DO)	126
20-8	External Control Input (DI).....	126
20-9	Logic Operation Functions.....	127
20-10	Heater Break Alarm (option).....	127
20-11	Analog Output (option)	128
20-12	Sensor Power Supply (option).....	128
20-13	Communication (option)	129
20-14	Infrared Communication	130
20-15	General Specifications.....	130

LCD Flow Chart

The following shows how to move between the LCD display screens of this device.

- Standard screen Screens that are always displayed
- Non-standard screen Screens that are displayed depending on options/setup values.

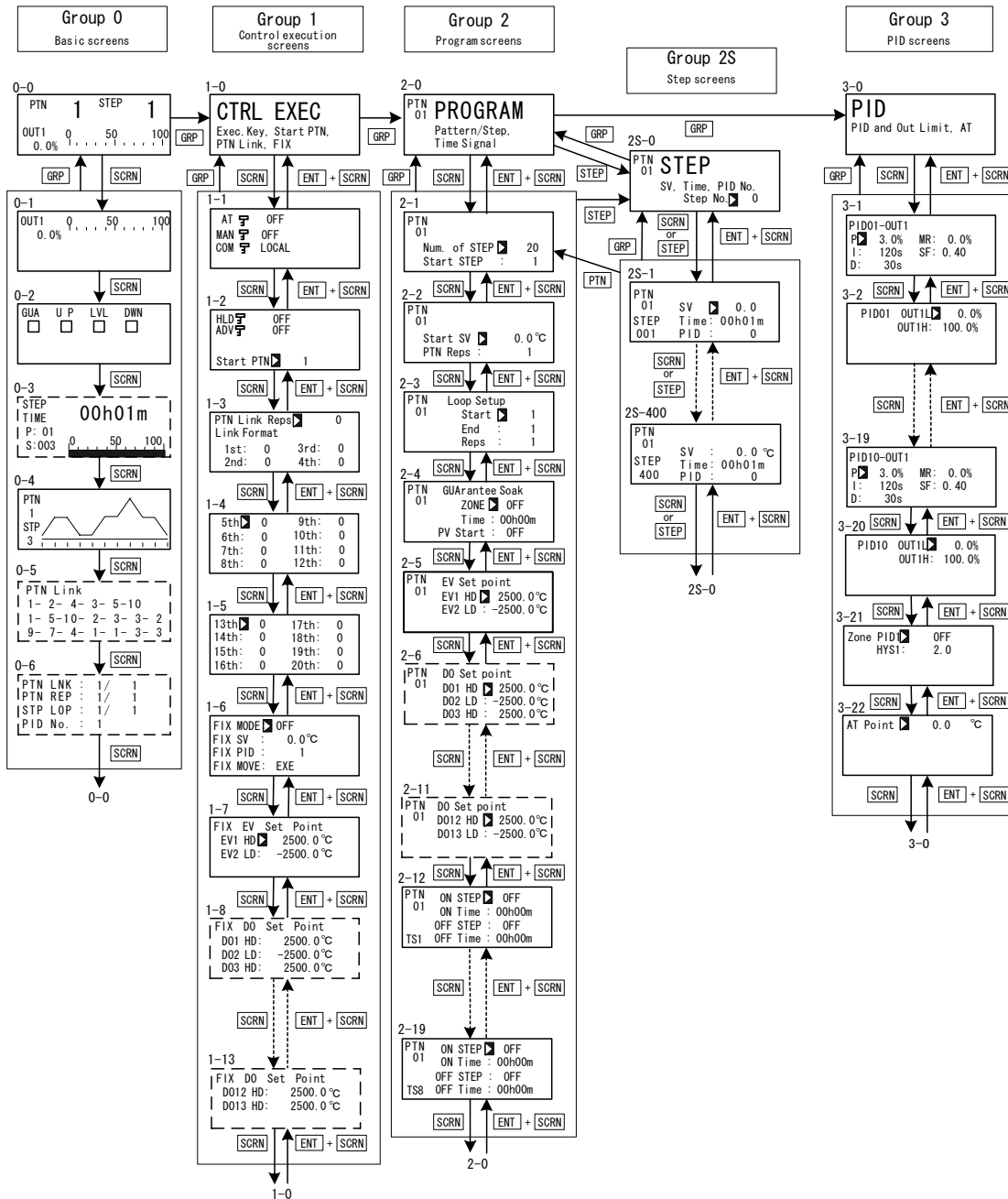

When the DISP key is pressed at a screen other than the 0-0 basic screen, the 0-0 basic screen is returned to.

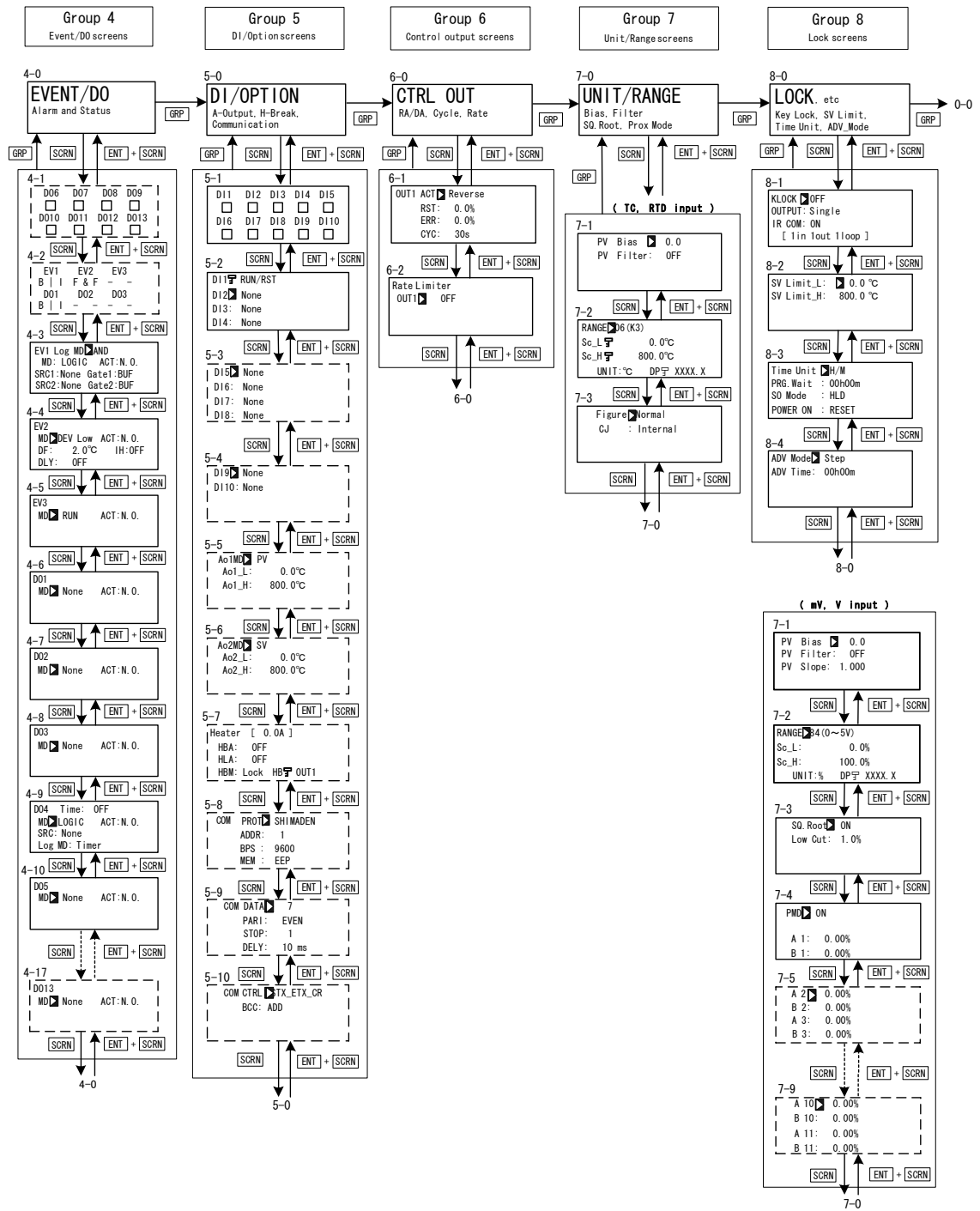

1 INSTALLATION & WIRING

1-1 Installation Site



Caution

Do not use this device in the following sites. Doing so might result in malfunction or damage to this device and in some cases cause fire and/or dangerous situations.

- ◆ Locations that are filled with or generate inflammable gas, corrosive gas, dirt and dust, smoke, etc.
- ◆ Locations that are subject to water droplets, direct sunlight or strong radiated heat from other equipment
- ◆ Locations where the ambient temperature falls below -10°C or rises above 50°C
- ◆ Locations where dew condensation forms and the humidity reaches 90% or more
- ◆ Near equipment that generates high-frequency noise
- ◆ Near heavy current circuits or locations likely to be subject to inductive interference
- ◆ Locations subject to strong vibration and impact
- ◆ Locations exceeding an elevation of 2000 m

1-2 External Dimensions and Panel Cutout

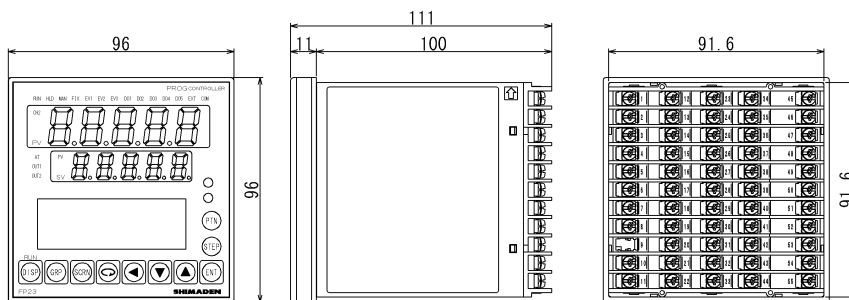

■ External dimensions

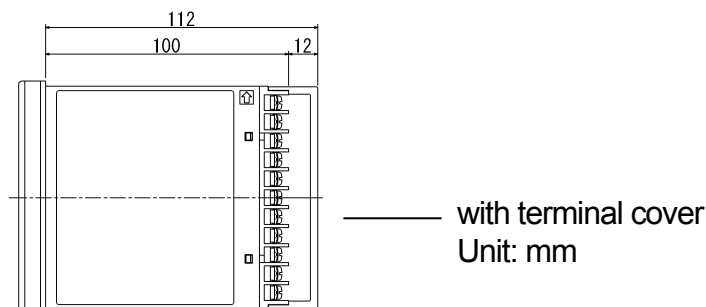

Panel cutout dimensions and space for gang mounting

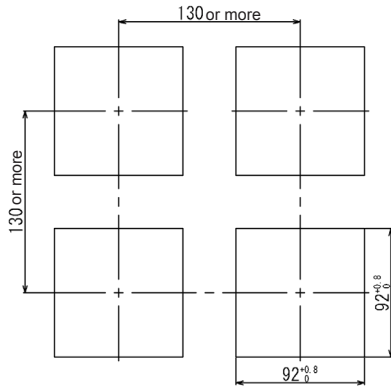

Unit: mm

1-3 Mounting



Caution

To ensure safety and maintain the functions of this device, do not disassemble this device.
If this device must be disassembled for replacement or repair, contact your dealer.

Follow the procedure below to mount this device on a panel.

1. Drill mounting holes referring to the panel cutout dimensions described in the previous section.
The applicable thickness of the mounting panel is 1.0 to 8.0 mm.
2. Press this device into the panel from the front of the panel.
3. Insert the mounting fixtures at the top and bottom of this device, and tighten the screws from behind to fasten the device in place.
4. Over-tightening the screws may deform or damage the device housing. Take care not to tighten the screws too tight.
5. After completing wiring after installation, attach the terminal cover.

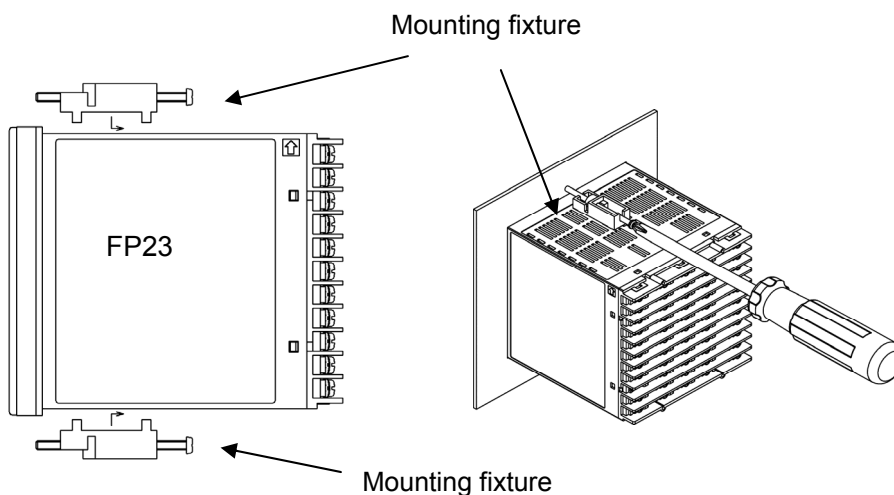

1-4 Current Transformer (CT) for Heater Break Alarm

The CT can be used when the heater Break alarm (option) is selected in the product specifications.

Either of the following CT is provided.

■ For 0 to 30A (CTL-6-S)

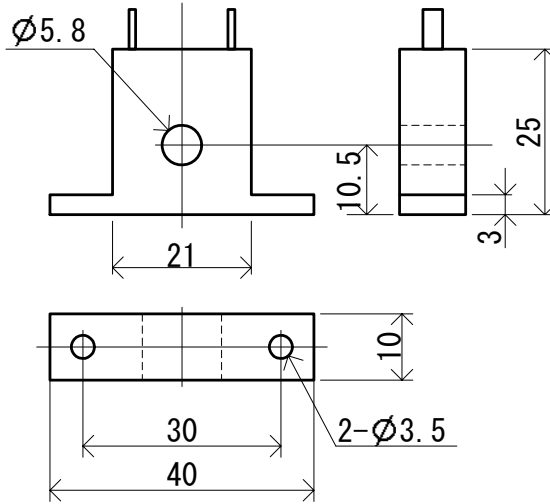

Unit: mm

■ For 0 to 50A (CTL-12-S36-8)

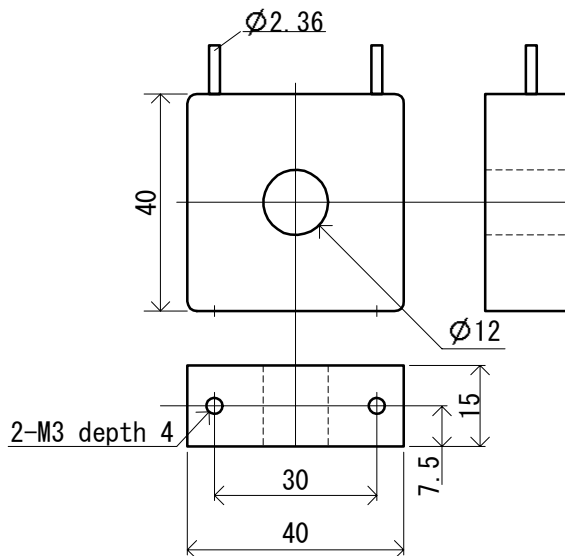

Unit: mm

1-5 Rear Terminal Arrangement Diagram

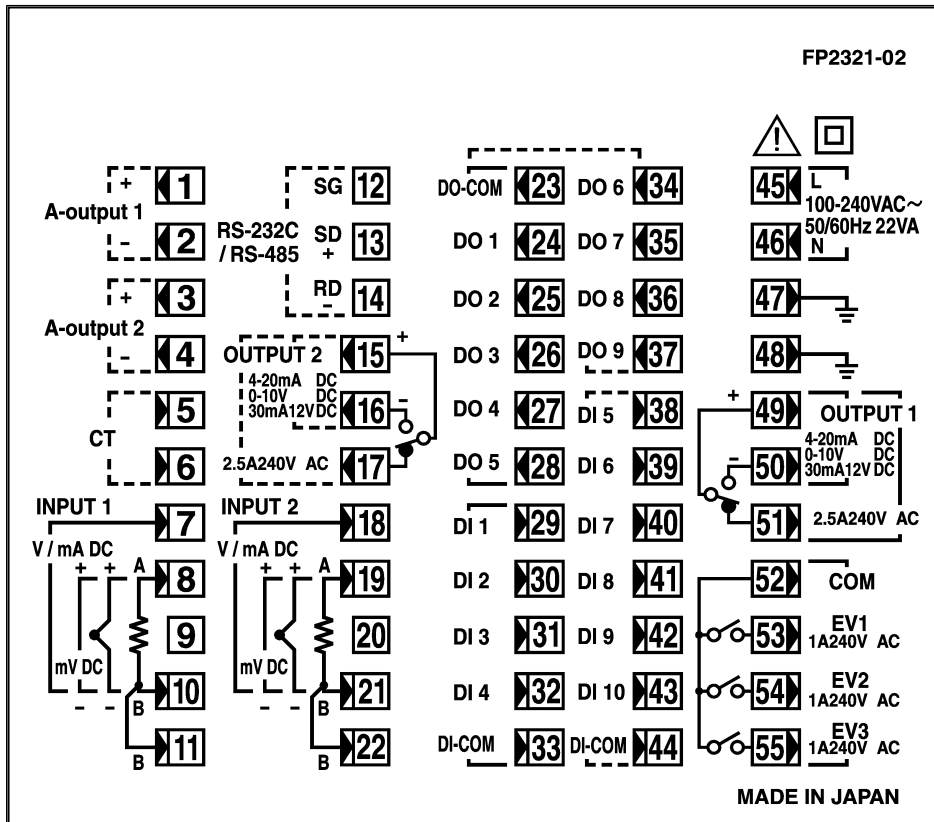

Terminal No	Symbol	Description	
1	+	Analog output 1	
2	-	(optional)	
3	+	Analog output 2 or	
4	-	Sensor power supply	
		(optional)	
5	+	Heater break alarm CT input	
6	-	(optional)	
8	+	mV,	Input
10	-	Thermocouple	
		input	
8	A	RTD input	
10	B		
11	B		
7	+	V, mA input	
10	-		
45	L	Power supply	
46	N		
47		Grounding (internal shorting	
48		across terminals)	
49	COM+	Control output 1	
50	NO -		
51	NC		
52	COM	Event output EV	
53	EV1	(standard)	
54	EV2		
55	EV3		
23	COM	External control output DO (standard)	Darlington output
24	DO1		
25	DO2		Open collector output
26	DO3		
27	DO4		
28	DO5		
29	DI1	External control output DI	
30	DI2	(standard)	
31	DI3		
32	DI4		
33	COM		
34	DO6	External control output DO	
35	DO7	Open collector output	
36	DO8	(optional)	
37	DO9		

Terminal No.	Symbol	Description
38	DI5	External input DI5 to DI10 (optional)
39	DI6	
40	DI7	
41	DI8	
42	DI9	
43	DI10	
44	COM	
12	SG	Communication function (optional)
13	SD+	
14	RD -	
15	COM+	Control output 2 (optional)
16	NO -	
17	NC	
18	DO10	External Control Output DO10 to DO13 Open collector output (optional)
19	DO11	
20	DO12	
21	DO13	
22	DO COM	

A receiving resistor of 1/2W 250Ω 0.1% is attached across input terminals (7-10) for use for the 0 to 20mA, and 4 to 20mA inputs.

1-6 Wiring

Caution

- To prevent electric shock, always turn off and disconnect this device from the power supply before starting wiring.
- Do not touch wired terminals or charged parts with your hands while the power is supplied.

Pay attention to the following points when performing wiring:

- ◆ Check that the wiring is free from mistakes according to "1-5 Rear Terminal Arrangement Diagrams."
- ◆ Use crimped terminals that accommodate an M3 screw and that have a width of 6.2 mm or less.
- ◆ For thermocouple input, use a compensation wire compatible with the type of thermocouple.
- ◆ For RTD input, the resistance of a single lead wire must be 10Ω or less and the three wires must have the same resistance.
- ◆ The input signal lead must not be passed along the same conduit or duct as that for high-voltage power lines.
- ◆ Shield wiring (single point grounding) is effective against static induction noise.
- ◆ Short interval twisted pair wiring is effective against electromagnetic induction noise.
- ◆ When wiring, use wire or cable (minimum 1 mm^2 cross-sectional area) of 600 V grade PVC insulated wire or equivalent wire having the same rating.
- ◆ For wiring the ground, ground the ground terminal with the earth resistance at less than 100Ω and with wire 2 mm^2 or thicker.
- ◆ Two earth terminals are provided, each connected internally. One is for the ground connection, and the other is for connecting the shield of the signal lead. Do not use the earth terminals for crossover wiring of the power system ground lead.
- ◆ If this device is considered as being susceptible to noise caused by the power supply, attach a noise filter to prevent abnormal functioning. Install a noise filter onto a grounded panel, and make the wire connecting the noise filter output and the power supply terminal on this controller as short as possible.

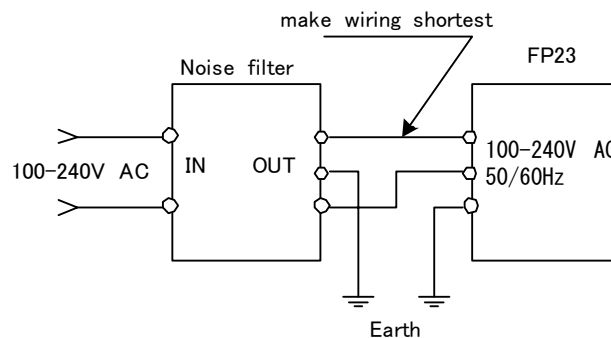

Recommended filter: ZMB2203-13 from TDK

2 NAMES & FUNCTIONS OF PARTS ON FRONT PANEL

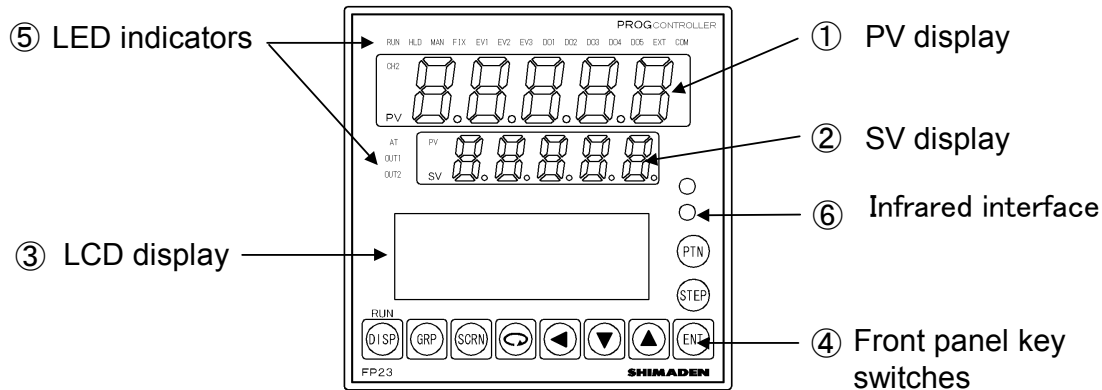

① PV display

Displays the measured value (PV).

Displays an error message when an error (e.g. scale over) occurs.

② SV display

Displays the target set value (SV).

③ LCD display (21 characters x 4 lines, max.)

◆ Pattern/step No. display

Displays the pattern/step No. in the Program mode.

In the " F " mode, "F" indicating the FIX mode is displayed at the PTN field and "- - -" is displayed at the STEP field.

"- - -" at the STEP field goes out during control execution (RUN) in the FIX mode.

◆ Output (OUT) display

The control output value is displayed by a numerical value and a bar graph as a percentage (%).

◆ Program monitor display

Displays the program status monitor.

◆ Remaining step time display

Displays the remaining step time during program operation.

◆ Pattern graph display

Displays the pattern (step) graph during program operation.













◆ Screen title display

Displays the screen group title in the respective screen group top screen.



◆ Setup parameter display

Parameters can be selected and displayed by front key operation.

④Key switches

 (Display key)	Displays the basic screen.
 (Group key)	Changes the screen group. Or, returns to the screen group top screen.
 (Screen key)	Switches the parameter display screen in a screen group.
 (Parameter key)	Selects the parameter to set up or change. The parameter to be changed is indicated by the cursor (▶).
 (Shift key)	Moves the digit in set numerical values.
 (Down key)	Decrements parameters and numerical values during setup.
 (Up key)	Increments parameters and numerical values during setup.
 (Entry key)	Registers data or parameter numerical values.
 (Step key)	At a reset, increments the start step No. in the basic screen. ( must be pressed to register.)
 (Pattern key)	At a reset, increments the start pattern No. in the basic screen. ( must be pressed to register.)

The following key combination operations are available in screens from 0-1 to 0-6.

 +  : Hold (HLD) operation

 +  : Advance (ADV) operation

⑤ LED indicators

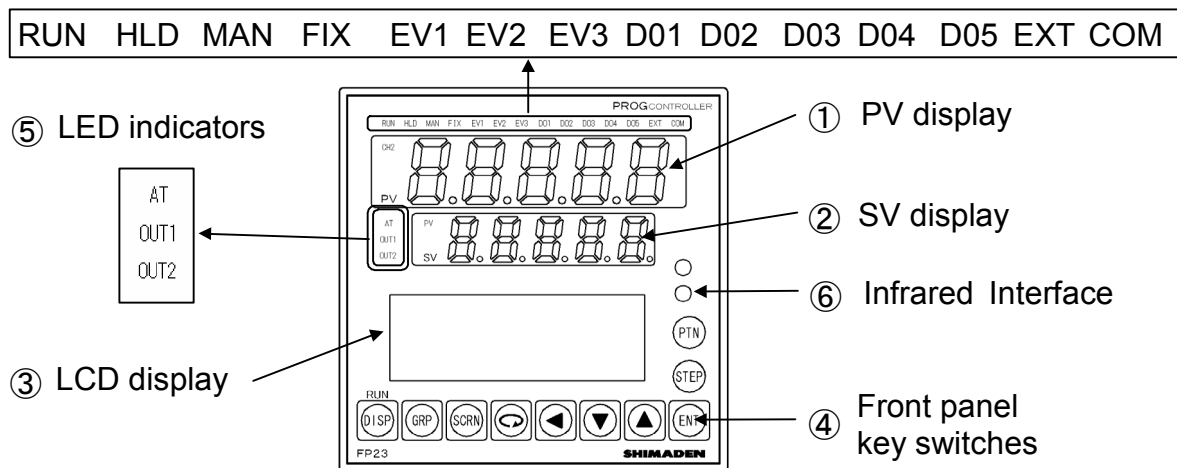

■ Status lamps

RUN	green	Lights during control is being executed. Blinks during program start delay time (PRG.Wait).
HLD	green	Lights when the program is paused in Program mode. Blinks when the pause has caused by an input error in the Program mode or in the Fix mode.
MAN	green	Blinks when control output is set to manual operation (MAN).
FIX	green	Lights in the FIX mode.
EV1	orange	Lights during EV1 action.
EV2	orange	Lights during EV2 action.
EV3	orange	Lights during EV3 action.
DO1	orange	Lights during DO1 action.
DO2	orange	Lights during DO2 action.
DO3	orange	Lights during DO3 action.
DO4	orange	Lights during DO4 action.
DO5	orange	Lights during DO5 action.
EXT	green	Lights when start pattern No. selection (PTN2bit, PTN3bit, PTN4bit, PTN5bit) are set to DI5 to DI8.
COM	green	Lights during communication (COM) mode.
AT	green	Lights during auto tuning standby. Blinks during auto tuning execution.
OUT1	green	When control output is current or voltage output, the brightness of this lamp changes according to fluctuation of Control Output 1, and during contact or SSR drive voltage output, this lamp lights when Control Output 1 is ON and goes Out when Control Output 1 is OFF.
OUT2	green	When control output is current or voltage output, the brightness of this lamp changes according to fluctuation of Control Output 2, and during contact or SSR drive voltage output, this lamp lights when Control Output 2 is ON and goes Out when Control Output 2 is OFF.

3 BASIC OPERATIONS

3-1 Power ON

When the power is turned ON, the basic screen is displayed after the initial screens are displayed on the LCD for about three seconds.

When the FP23 is powered ON for the first time, check on screen to make sure that this device is the one you ordered.

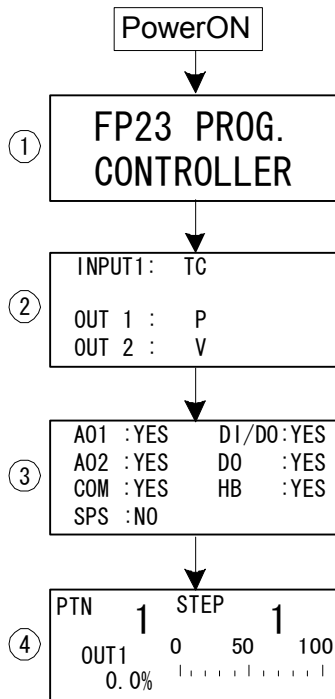

The series name is displayed.

① **The I/O type is displayed.**

The figure shows a thermocouple (TC) set for Input 1, SSR drive voltage (P) set for Output 1, and output (V) set for Output 2.

② **The installation status of option functions is displayed.**

The figure shows that Analog Output 1, Analog Output 2 and the communication function are installed (YES), DI (10 points) and DO (9 points) are installed (YES), and DO 13 points and the heater break alarm are installed (YES), and no SPS (sensor power supply) is not available (NO).

③ **Basic screen (Monitor Group top screen)**

The figure shows that Output 1 is 0%.

The details displayed on screen vary according to specifications, or according to preset function specifications.

Note

- ♦ The actually installed numbers for external DI or DO can be confirmed with the above ③ screen.

LCD Display		Actual numbers	
DI/DO	DO	DI	DO
NO	NO	4	5
YES	NO	10	9
YES	YES	10	13

3-2 Switching LCD Screen Display and Moving the Cursor

(1) Switching the screen display

For details on moving between screens, see "LCD Flow Chart" in the preface.

The operation screens of this device are configured so that screens are displayed in order from the most frequently used screen in regular use.

The following shows an example of screens in the 1-input/1-output specification.

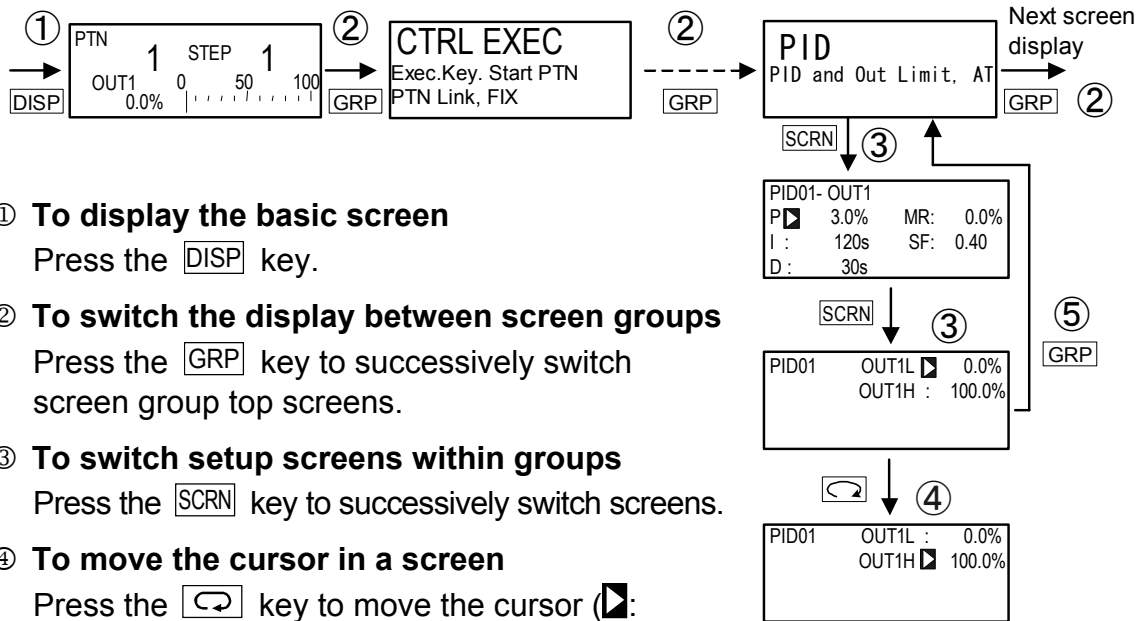









- ① **To display the basic screen**
Press the **DISP** key.
- ② **To switch the display between screen groups**
Press the **GRP** key to successively switch screen group top screens.
- ③ **To switch setup screens within groups**
Press the **SCRN** key to successively switch screens.
- ④ **To move the cursor in a screen**
Press the **SCRN** key to move the cursor (blinking) when there are two or more parameters in the same screen.
- ⑤ **To display the top screen**
Press the **GRP** key in a respective parameter setup screen other than the basic screen group to switch to the top screen of a screen group.

3-3 Changing and Registering Data

Basically, set up and change parameters while confirming the LCD screen display.

(1) Entering numerical values

1. When there are two or more parameters, press the  key to move the cursor () to the parameter to be changed.
2. Press the  or  ,  keys. The smallest digit of the numerical value blinks.
3. Press the  key again. Move the blinking section in the numerical value to the digit to be changed, and change the value using the  or  key.
4. Press the  key. The numerical value is fixed and registered, and stops blinking.

■ Changing a numerical value setting (example)

The following shows the procedure for changing the value of PID parameter I to 100 s.

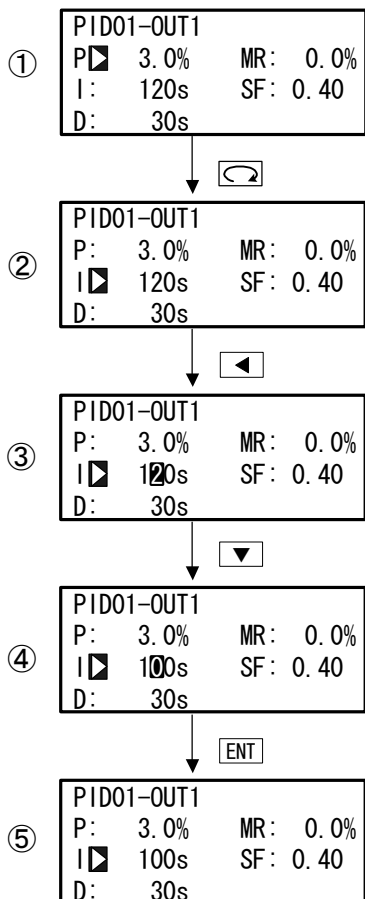



① To move between screens

Press the  key three times in the initial screen to display the top screen of the PID screen (group 3).

Next, press the  key once.

② To move the cursor from P to I

Press the  key once to move the blinking cursor () to I.

③ To make the I numerical value blink and move to the 10's digit

Press the  key twice to move the blinking cursor to the 10's digit.

④ To change the numerical value of the 10's digit to 0





Press the  key to change the display from "2" to "0".

⑤ To fix and register the setting

Press the  key to fix the new setting.

(2) Selecting setup items

The settings of parameters marked by a  key mark cannot be changed.

1. When there are two or more parameters, press the  key to move the cursor () to the parameter to be changed.
2. Change the parameter settings by the  or  key, check the setting, and press the  key to fix and register settings. The character stops blinking.

■ Selecting a parameter (example)

The following shows the procedure for changing control output to manual in the RUN mode.

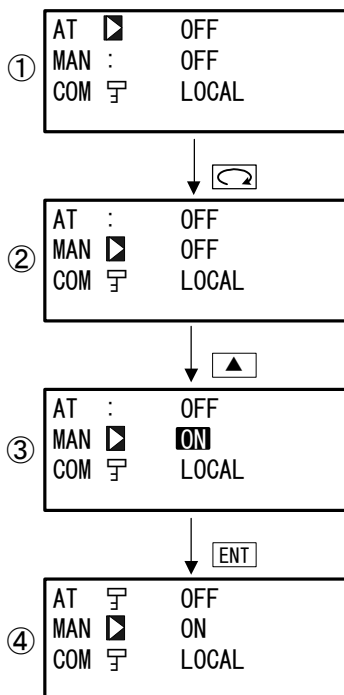



① To move between screens

Press the  key once in the initial screen to display the top screen of the execution screen (group 1).

Next, press the  key once.

② To move the cursor from AT to MAN

Press the  key once to move the blinking cursor () to MAN.

③ To change the MAN setting from OFF to ON

Press the  key to change the display from OFF to ON.

④ To fix and register the setting

Press the  key to fix the new setting.

In this case, Auto Tuning can no longer be executed, and the key mark is displayed.

4 CONTROL MODES & FUNCTION BLOCKS

4-1 Control Modes

The FP23 has two control modes.

They are the "Program mode" for performing program operation, and the "FIX mode" for performing fixed value control.

The following illustrates how to move between the two modes.

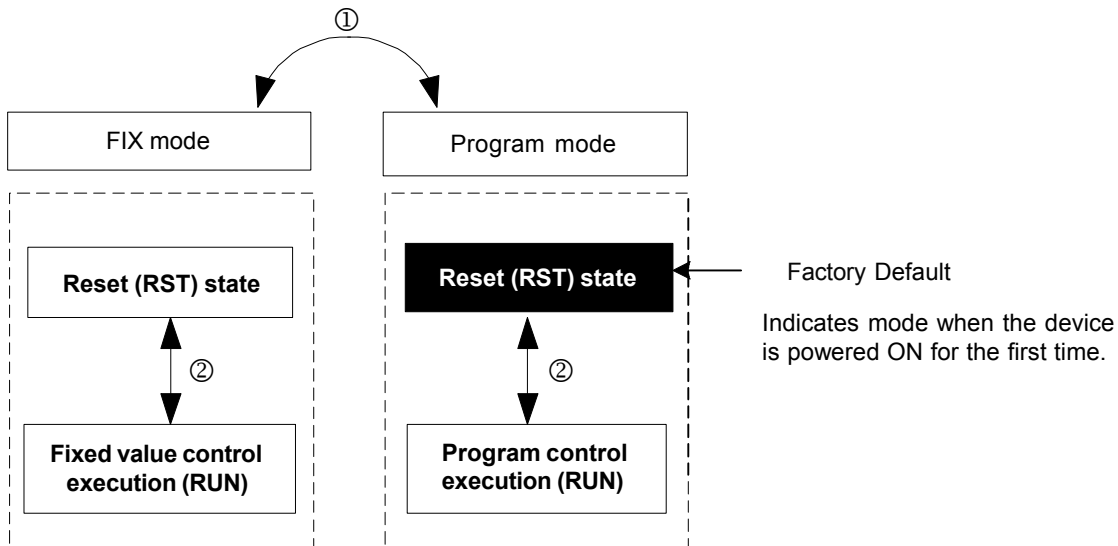

The control mode is switched by the FIX mode ON/OFF settings in the FIX MODE screen (No.1 to 6). The Mode switches to the FIX (fixed value) mode when ON is set, and to the Program mode when OFF is set.

Switch RST/RUN by the **ENT** + **DISP** keys.

4-2 Reset State

The FP23 does not execute control when it is in a Reset State in both the Program mode and the FIX mode.

Note, however, that output at reset can be set in advance.

For details, see "8-3(2) Output at reset."

Also, when the operation modes shown in the next page are assigned to EVENT/DO, EVENT/DO are not output in a reset state.

EVENT/DO operation modes that are not output in a reset state

Type	Action	Type	Action
DEV Hi	Higher limit deviation	DEV In	Inside higher/lower limit deviation
DEV Low	Lower limit deviation	PV Hi	PV higher limit absolute value
DEV Out	Outside higher/lower limit deviation	PV Low	PV lower limit absolute value

4-3 Program Functions

Up to 20 steps x 20 patterns can be stored to memory on this device. Steps can be freely assigned as long as the total number of steps to assign to each pattern is within 400 steps.

For example, when you have completely used up the steps, set the number of steps allocated to pattern 20 to 0 (20 to 0), and change the number of steps in pattern 1 to 40 (20 to 40) as shown in the following example.

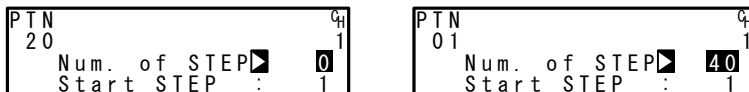

In this case, pattern 20 cannot be used in the program.

The FP23 is also installed with various program setup functions such as the pattern link function, pattern execution function, and step loop function. The following briefly introduces these functions.

■ **Pattern link function**

Each of the patterns can be linked. The pattern link can be set in any order. Linking is not performed when the pattern link is set to 0.

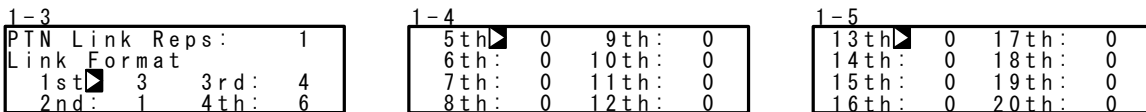

■ **Pattern link execution function**

Linked patterns can be executed repeatedly 1 to 9999 times.

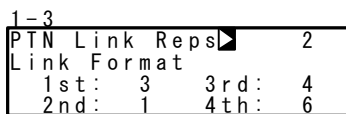

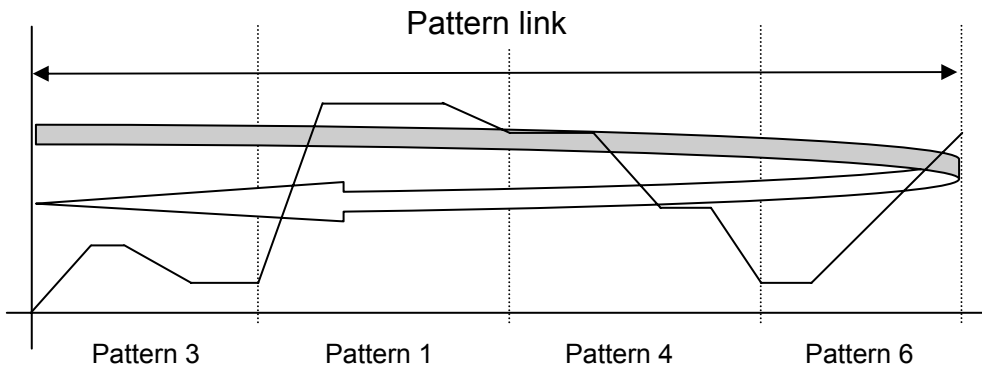

■ **Pattern execution function**

Any pattern can be executed repeatedly 1 to 9999 times

2-2	
PTN	01
Start SV:	0.0°C
PTN Repr	2

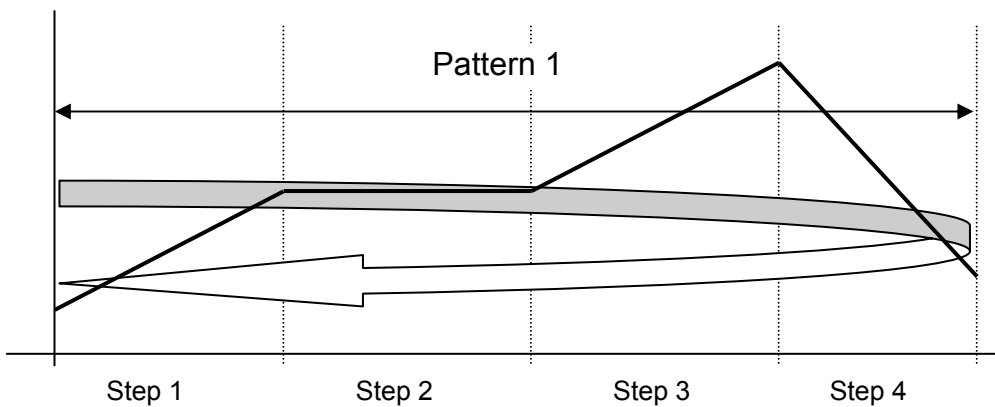

■ **Step loop function**

Any step can be executed repeatedly 1 to 9999 times.

2-3	
PTN	Loop Setup
01	Start
	End
	Reps
	2

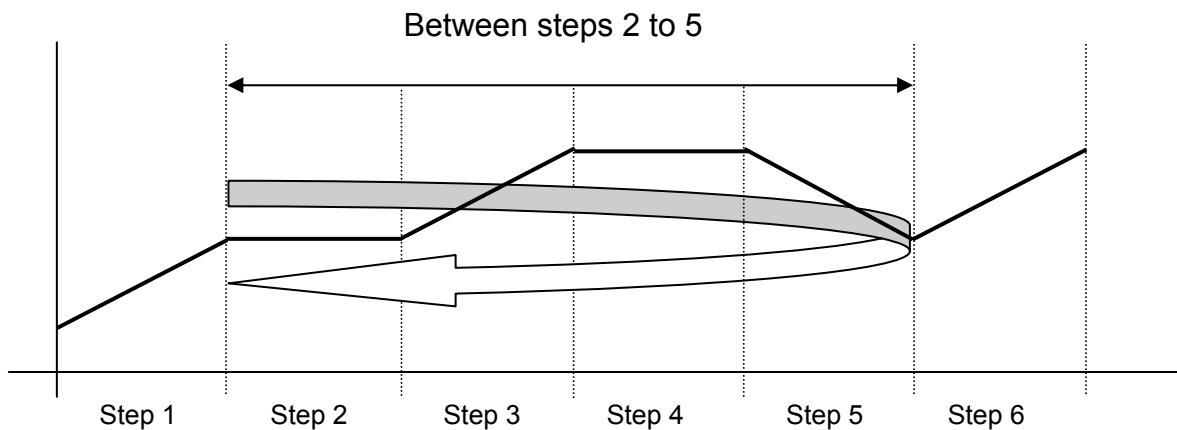

4-4 CONTROL FUNCTION BLOCK DIAGRAMS

(1) 1-input, 1-output/2-output

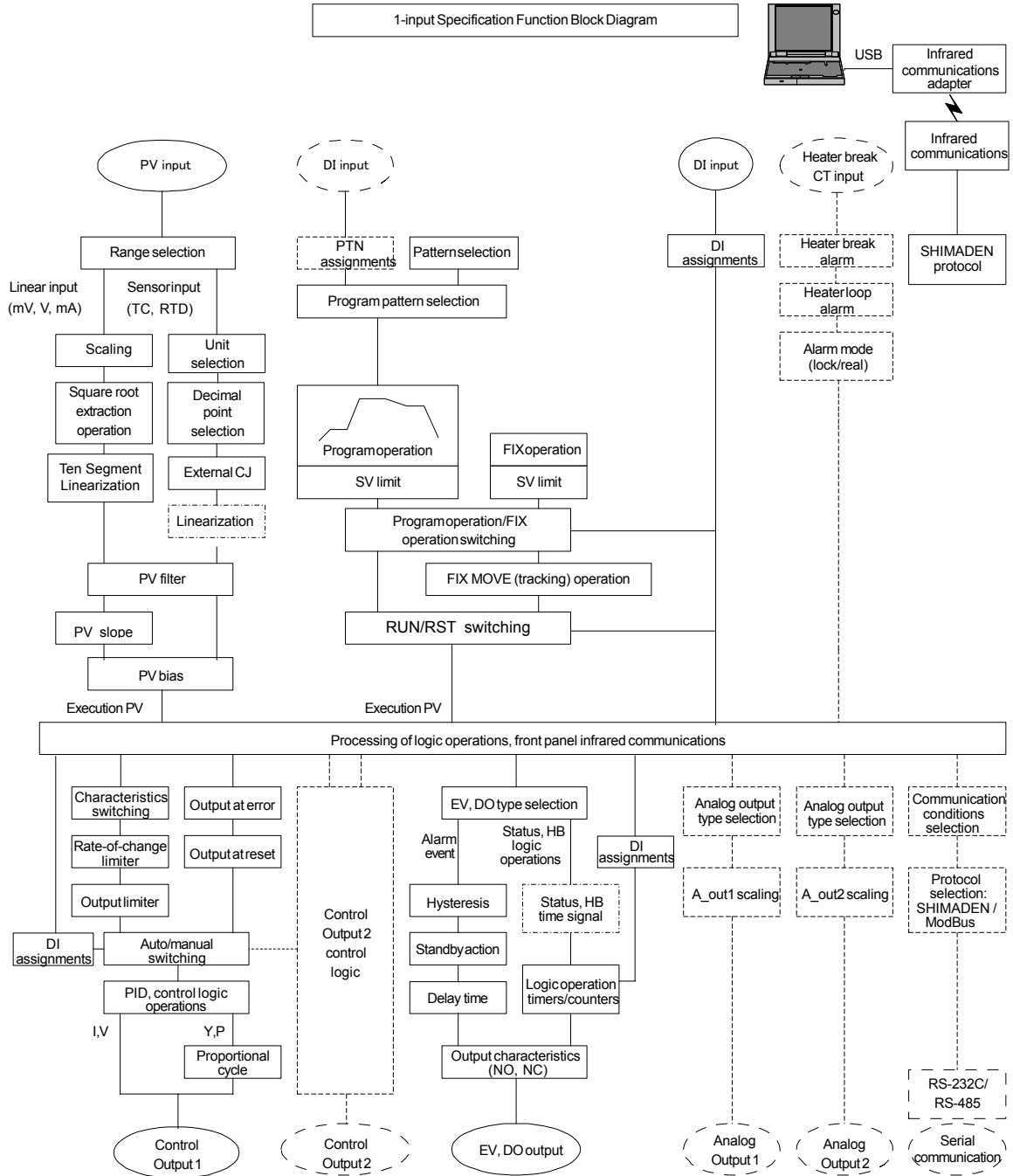

5 SETUP

5-1 Parameter Setup Procedure

Follow the procedure below to set up this device or change device settings when you use this device for the first time, change the operation parameters during use, or the control target device has been changed, for example.

Caution

With some operations, when you initialize this device, all parameter settings return to their factory defaults.
Before you initialize this device, note down and retain settings as required.

It is assumed that experienced personnel familiar with basic operation of this device will set up this device.

Users other than device manufacturers should thoroughly familiarize themselves with the functions to be used before they start to operate or set up this device.

Basic operations and setup of this device are described in detail from Chapter 6 onwards by following programming procedures.

Some screens and parameters are not displayed when option functions are not added on or when option functions are not selected.

For an overview of operation screens and how to move between screens, see "LCD Flow Chart" in the preface. For an overview of setup parameters, see "18. List of Parameters."

Set up parameters in the order shown below.

1. Confirm the Output Specification and Release the Key Lock.
Perform this as necessary.
For details, see "Chapter 6."
2. I/O Settings
For details, see "Chapter 7."
3. I/O Auxiliary Settings
For details, see "Chapter 8."
4. Program Settings
Make "program initial settings," "step-related settings," "pattern-related settings," "pattern link-related settings," and "settings before program operation."
For details, see "Chapter 9."
5. FIX Settings
For details, see "Chapter 10."

- 6. PID Setting**
For details, see "Chapter 11."
- 7. EVENT & DO Settings**
For details, see "Chapter 12."
- 8. Option (HB, COM, DI, AO) Settings**
For details, see "Chapter 13."
- 9. Key Lock Setting**
When setup of parameters are completed, set the key lock as necessary to prevent inadvertent operation.
For details, see "Chapter 14."
- 10. Monitoring, Executing & Stopping Operation**
For details, see "Chapter 15."
- 11. Operations During Control**
For details, see "Chapter 16."

6 OUTPUT SPECIFICATION & KEY LOCK

Perform the following as necessary.

6-1 Confirming the Output Specification

The current output specification is displayed at the bottom row of the key lock, number of outputs setting screen (No.8-1).

8-1

KLOCK	OFF
OUTPUT:	Single
IR COM:	ON
[1in 1out 1loop]	

1in 1out 1loop:	1-output controller
1in 2out 1loop:	2-output controller

6-2 Releasing the Key Lock

(1) Key lock screen display

To call up the LOCK, etc. screen group (group 8) from the basic screen, press the **[GRP]** key.

Press the **[SCRN]** key in the LOCK, etc. screen group to switch to the screens for making and changing setups.

Select parameters in screens by pressing the **[↻]** key.

Set parameters by pressing the **[◀]**, **[▼]** or **[▲]** key, and press the **[ENT]** key to fix and register settings.

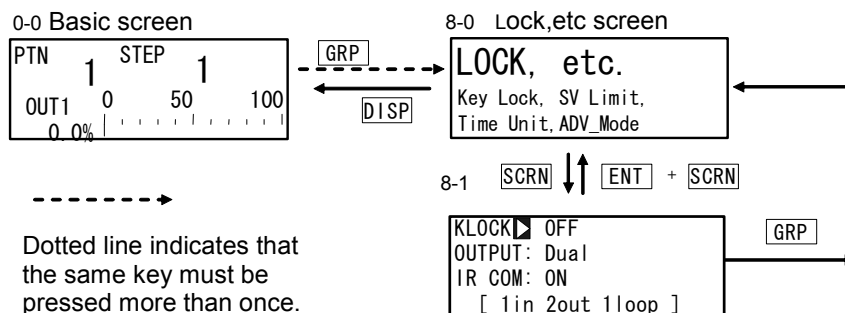

(2) Releasing the key lock

When the key lock is applied, the **☒** (key mark) is displayed at the relevant parameter on the LCD screen indicating that the parameter cannot be set or its settings changed. The following shows the procedure for releasing the key lock.

8-1	Setting range	OFF, LOCK1, LOCK2, LOCK3
<div style="border: 1px solid black; padding: 5px; width: fit-content;"> KLOCK ☒ OFF OUTPUT: Dual IR COM: ON [1in 2out 1loop] </div>	Initial value	OFF

- OFF Release the key lock
- LOCK1 Locks parameters other than SV related, AT, MAN, or EVENT/DO action points
- LOCK2 Locks parameters other than SV related
- LOCK3 Locks all parameters (excluding the key lock parameter itself)

For details on parameters that are locked, see "18 List of Parameters."

7 I/O SETTINGS, INFRARED COMMUNICATION

7-1 Output Specifications (2-output specification)

This item is displayed in the case of the 1-input/2-output specification.
At this item, select either 1-output action (Single) or 2-output action (Dual).
When action is set to Single, control output becomes the output of OUT1 only.

Select the output mode after setting control action to the Reset State.
For details on operation to stop control, see "4-1 Control Modes."

8-1	Setting range	Single, or Dual
	Initial value	Single

Single 1-output control action
Only OUT1 is used for control output.

Dual 2-output control action
OUT1 and OUT2 are used for control output.

◆Displaying the current operation mode

The current operation mode is displayed at the bottom line of the key lock and number of outputs setup screen (No. 8-1).

1in 1out 1loop : 1-output controller
1in 2out 1loop : 2-output controller

7-2 Infrared Communication

Allow the infrared communication using S5004 (Infrared Communication Adapter, selling separately). IR COM should be ON before the instrument parameters are set via infrared communication.

Parameter Assistant Software is also used for this communication. For details, see "Parameter Assistant Instruction Manual" which can be accessed from its Help menu.

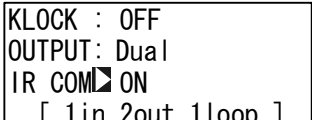
8-1	Setting range	ON, OFF
	Initial value	ON

ON Infrared communication by S5004 is available.

OFF Infrared communication by S5004 is not available.

7-3 Measuring Range

Before performing setup, set control action to Reset State.

For details on operation to stop control, see "4-1 Control Modes."

(1) Range setting

```

7-2
RANGE▶06 (K3)
Sc_L:    0.0°C
Sc_H:    800.0°C
UNIT:°C  DP XXXX.X
  
```

Setting range 01 to 19, 31 to 58, 71 to 77, 81 to 87

Initial value 06 (K3)

When the range is changed in the above screen, the following confirmation message will be displayed.

Press the key to select YES, and press the key to apply the setting.

```

WARNING
Params Initialize
proceed? NO
  
```

→

```

WARNING
Params Initialize
proceed? YES
  
```

Caution

- ◆ When the range is changed, the above warning message will be displayed, and parameters will be initialized. For details on parameters that are initialized, see "18 List of Parameters"

(2) Range scaling

This item is set during voltage input and current input, and cannot be set during RTD and TC input. Set the measurement range (scaling). Sc_L is scaling of the lower limit side of PV, and Sc_H is scaling of the higher limit side of PV.

```

7-2
RANGE: 71 (-10~10mV)
Sc_L: 0.0%
Sc_H: 100.0%
UNIT:% DP: XXXX.X

```

Settable range -19999 to 30000 Unit
 Measuring range Minimum span: 10 Unit
 Maximum span: 30000 Unit
 Any setting within the above ranges is possible.
 (Note that Sc_L < Sc_H)
 Initial value Sc_L: 0 Unit
 Sc_H: 1000 Unit

The maximum span is $(Sc_H - Sc_L) \leq 30000$.

When an Sc_L is set that causes the span to exceed 30000, a value that does not exceed span is automatically set to Sc_H.

When scaling is changed in the above screen, the following confirmation message will be displayed.

Press the key to select YES, and press the key to apply the setting. The range will be changed.

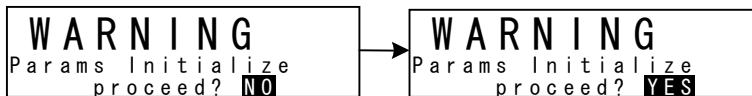

Caution

- ◆ When the range is scaled, the above warning message will be displayed, and parameters will be initialized.
 For details on parameters that are initialized, see "18 List of Parameters."
-

Measuring Range Code Table

Input Type	Sensor Type	Code	Symbol	Measuring range	Measuring range	
Universal Input	Thermo-couple	B *1	01	B	0.0 to 1800.0 °C	0 to 3300 °F
		R	02	R	0.0 to 1700.0 °C	0 to 3100 °F
		S	03	S	0.0 to 1700.0 °C	0 to 3100 °F
		K	04	K1	-100.0 to 400.0 °C	-150.0 to 750.0 °F
		K	05	K2	0.0 to 400.0 °C	0.0 to 750.0 °F
		K	06	K3	0.0 to 800.0 °C	0.0 to 1500.0 °F
		K	07	K4	0.0 to 1370.0 °C	0.0 to 2500.0 °F
		K *2	08	K5	-200.0 to 200.0 °C	-300.0 to 400.0 °F
		E	09	E	0.0 to 700.0 °C	0.0 to 1300.0 °F
		J	10	J	0.0 to 600.0 °C	0.0 to 1100.0 °F
		T *2	11	T	-200.0 to 200.0 °C	-300.0 to 400.0 °F
		N	12	N	0.0 to 1300.0 °C	0.0 to 2300.0 °F
		PL II	13	PLII	0.0 to 1300.0 °C	0.0 to 2300.0 °F
		PR40-20 *3	14	PR40-20	0.0 to 1800.0 °C	0 to 3300 °F
		WRe5-26	15	WRe5-26	0.0 to 2300.0 °C	0 to 4200 °F
		U	16	U	-200.0 to 200.0 °C	-300.0 to 400.0 °F
		L	17	L	0.0 to 600.0 °C	0.0 to 1100.0 °F
		K *4	18	K	10.0 to 350.0 K	10.0 to 350.0 K
		AuFe-Cr *5	19	AuFe-Cr	0.0 to 350.0 K	0.0 to 350.0 K
	RTD	Pt100 (new)JIS/IEC	31	Pt 1	-200.0 to 600.0 °C	-300.0 to 1100.0 °F
32			Pt 2	-100.00 to 100.00 °C	-150.0 to 200.0 °F	
33			Pt 3	-100.0 to 300.0 °C	-150.0 to 600.0 °F	
34			Pt 4	-60.00 to 40.00 °C	-80.00 to 100.00 °F	
35			Pt 5	-50.00 to 50.00 °C	-60.00 to 120.00 °F	
36			Pt 6	-40.00 to 60.00 °C	-40.00 to 140.00 °F	
37			Pt 7	-20.00 to 80.00 °C	0.00 to 180.00 °F	
38			Pt 8 *6	0.000 to 30.000 °C	0.00 to 80.00 °F	
39			Pt 9	0.00 to 50.00 °C	0.00 to 120.00 °F	
40			Pt10	0.00 to 100.00 °C	0.00 to 200.00 °F	
41			Pt11	0.00 to 200.00 °C	0.0 to 400.0 °F	
42			Pt12 *7	0.00 to 300.00 °C	0.0 to 600.0 °F	
43			Pt13	0.0 to 300.0 °C	0.0 to 600.0 °F	
44			Pt14	0.0 to 500.0 °C	0.0 to 1000.0 °F	

Input Type	Sensor Type	Code	Symbol	Measuring range	Measuring range
Universal Input	RTD Pt100 (old) JIS/IEC	45	JPt 1	-200.0 to 500.0 °C	-300.0 to 900.0 °F
		46	JPt 2	-100.00 to 100.00 °C	-150.0 to 200.0 °F
		47	JPt 3	-100.0 to 300.0 °C	-150.0 to 600.0 °F
		48	JPt 4	-60.00 to 40.00 °C	-80.00 to 100.00 °F
		49	JPt 5	-50.00 to 50.00 °C	-60.00 to 120.00 °F
		50	JPt 6	-40.00 to 60.00 °C	-40.00 to 140.00 °F
		51	JPt 7	-20.00 to 80.00 °C	0.00 to 180.00 °F
		52	JPt 8 *6	0.000 to 30.000 °C	0.00 to 80.00 °F
		53	JPt 9	0.00 to 50.00 °C	0.00 to 120.00 °F
		54	JPt10	0.00 to 100.00 °C	0.00 to 200.00 °F
		55	JPt11	0.00 to 200.00 °C	0.0 to 400.0 °F
		56	JPt12 *7	0.00 to 300.00 °C	0.0 to 600.0 °F
		57	JPt13	0.0 to 300.0 °C	0.0 to 600.0 °F
		58	JPt14	0.0 to 500.0 °C	0.0 to 900.0 °F
Voltage (mV)	-10 to 10 mV	71	-10 to 10 mV	Initial value : 0.0 to 100.0 Measuring range : Any value in the following ranges can be set by the scaling function. Scaling range : -19999 to 30000 counts Span : 10 to 30000 counts Scale over occurs when the input measured value exceeds 32000. When used with 0 to 20 mA, 4 to 20 mA current input, select either of measuring range codes 84 and 85, and attach a shunt resistor of 1/2W, 250Ω±0.1% to the input terminals.	
	0 to 10 mV	72	0 to 10 mV		
	0 to 20 mV	73	0 to 20 mV		
	0 to 50 mV	74	0 to 50 mV		
	10 to 50 mV	75	10 to 50 mV		
	0 to 100 mV	76	0 to 100 mV		
	-100 to 100 mV	77	-100 to 100 mV		
Voltage (V)	-1 to 1 V	81	-1 to 1 V		
	0 to 1 V	82	0 to 1 V		
	0 to 2 V	83	0 to 2 V		
	0 to 5 V	84	0 to 5 V		
	1 to 5 V	85	1 to 5 V		
	0 to 10 V	86	0 to 10 V		
	-10 to 10 V	87	-10 to 10 V		
<p>*1 : The accuracy of thermocouple B is not guaranteed at temperatures 400°C and 750°F or below.</p> <p>*2 : Accuracy at temperatures -100°C (-148°F) or below ±(0.5%FS+1 digit).</p> <p>*3 : Accuracy is ±(0.3%FS+1°C).</p> <p>*4 : The accuracy of thermocouple K is ±(0.75%FS+1K)/10.0 to 30.0K, ±(0.30%FS+1K)/30.0 to 70.0K, ±(0.25%FS+1K)/70.0 to 350.0K.</p> <p>*5 : The accuracy of thermocouple AuFe-Cr is ±(0.25%FS+1K).</p> <p>*6 : The higher limit side scale over occurs when the input measured value exceeds 32.000.</p> <p>*7 : The higher limit side scale over occurs when the input measured value exceeds 320.00.</p>					

7-4 Unit

Set the measurement unit.

```

7-2
RANGE: 71 (-10~10mV)
Sc_L: 0.0%
Sc_H: 100.0%
UNIT: % DP: XXXX.X
  
```

RTD, TC:
 Setting range °C, °F
 Initial value °C

Voltage, Current:
 Setting range °C, °F, %, None
 Initial value %

Only temperature (°C or °F) can be selected for RTD or TC input.

When the unit is changed in the above screen, the following confirmation message will be displayed at TC and RTD input. At voltage or current input, this warning message will not be displayed.

Press the key to select YES, and press the key to apply the setting. The unit will be changed.

```

WARNING
Params Initialize
proceed? NO
  
```

→

```

WARNING
Params Initialize
proceed? YES
  
```

Caution

- ◆ When the unit is changed, the above warning message will be displayed, and parameters will be initialized. For details on parameters that are initialized, see "18 List of Parameters."

7-5 Decimal Point Position

(1) Decimal point position

This item can be set during voltage input, and cannot be set during RTD and TC input. Set the decimal point position for PV display.

7-2		Setting range	xxxx.x to x.xxxx
	RANGE: 71 (-10~10mV)	Initial value	xxxx.x
	Sc_L: 0.0%		
	Sc_H: 100.0%		
	UNIT: % DP XXXX.X		

(2) Switching the lowest digit past the decimal point

The lowest digit past the decimal point of measuring ranges determined by the range setting can be set.

Note, however, that this function cannot be used for measurement ranges without digits past the decimal point.

This screen is not displayed in the case of voltage input and current input.

7-3		Setting range	Normal, Short
	Figure Normal	Initial value	Normal
	CJ : Internal		

When "Figure" is changed in the above screen, the following confirmation message will be displayed.

Press the key to select YES, and press the key to apply the setting. "Figure" will be changed.

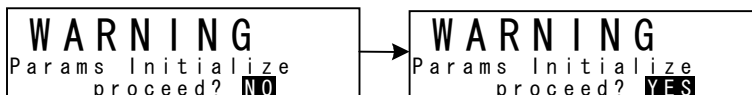

Caution

- ◆ When the lowest digit is changed, the above warning message will be displayed, and parameters will be initialized. For details on parameters that are initialized, see "18 List of Parameters."

7-6 Cold Junction Compensation

(1) Thermocouple cold junction compensation

Set whether to perform cold junction compensation during TC input internally or externally.

Normally, set to internal compensation. Set to external compensation when greater accuracy is required.



Setting range

Internal, External

Initial value

Internal

8 I/O AUXILIARY SETTINGS

8-1 PV Compensation Value

(1) PV bias

This item is used to compensate for error in the indicated temperature, for example, in the sensor/connected peripherals.

7-1	
PV Bias	0.0
PV Filter	OFF
PV Slope	1.000

Setting range -10000 to 10000 Unit

Initial value 0 Unit

(2) PV filter

When the PV signal contains noise, the control result sometimes is adversely affected by fluctuation of PV signals.

The PV filter is used to decrease this influence and stabilize control.

7-1	
PV Bias	0.0
PV Filter	OFF
PV Slope	1.000

Setting range OFF, 1 to 100 s

Initial value OFF

PV filtering is performed by First Order Lag computation.

The filter time constant can be set up to 100 seconds.

When a large time constant is set, noise removal performance increases. However, in control systems having a fast response, noise removal is adversely affected.

(3) PV slope

This item sets the PV slope during voltage input and current input.

The screen is not displayed during RTD and TC input.

7-1	
PV Bias	0.0
PV Filter	OFF
PV Slope	1.000

Setting range 0.500 to 1.500

Initial value 1.000

Execution PV = A x X + B where, A=PV input, X=PV slope, B=Bias

When this item is used in combination with square root extraction operation and linearizer approximation, this slope is applied to the result of square root extraction operation and linearizer approximation.

8-2 Square Root Extraction Operation

Signals having square root characteristics such as in the measurement of flow rates can be linearized.

This item is set during voltage input and current input.

This item is not displayed in the case of RTD or TC input.

(1) Enabling the square root extraction operation

The square root extraction operation function is valid when SQ.Root is set to ON.

7-3
SQ. Root ▾ OFF

Setting range ON, OFF
Initial value OFF

(2) Low cut

This item functions only when the square root extraction operation function is enabled.

Low cut processing is performed on the input before square root extraction operation is performed.

7-3
SQ. Root: ON
Low Cut ▾ 1.0%

Setting range 0.0 to 5.0%
Initial value 1.0%

In square root operation, the PV fluctuates greatly by a slight fluctuation of the input value in the vicinity of signal zero.

"Low cut" is a function for outputting "0" (zero) to PV at the preset input value or lower.

Setting low cut prevents action from becoming unstable when there is noise on the input signal line.

The set value of low cut is 0.0 to 5.0% of the PV input range.

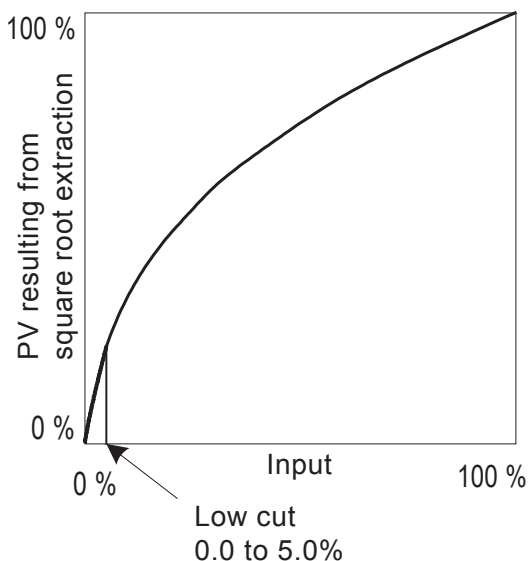

8-3 Control Output

(1) Action characteristics

Select either reverse action (heating specifications) or direct action (cooling specifications) as the output characteristics.

6-1	0UT1 ACT: <input checked="" type="checkbox"/> Reverse RST: 0.0% ERR: 0.0% CYC: 30s	Setting range	Reverse, Direct
		Initial value	Reverse

Reverse By this action, the smaller the measured value (PV) than the set value (SV), the higher the output.

This action is generally used for heating control.

Direct By this action, the larger the measured value (PV) than the set value (SV), the higher the output.

This action is generally used for cooling control.

Note

- ◆ Output characteristics cannot be switched during execution of auto tuning (AT).

(2) Output at reset

Use this item to maintain control output at a fixed value in a reset state.

6-1	0UT1 ACT: Reverse RST: <input checked="" type="checkbox"/> 0.0% ERR: 0.0% CYC: 30s	Setting range	0.0 to 100.0%
		Initial value	0.0%

Note

- ◆ In ON-OFF control (P=OFF), when output at reset is set to 50% or more, the actual output at reset becomes 100%.
When output at reset is set to 49.9% or less, the actual output at error becomes 0%.
- ◆ Output at reset is maintained without being affected by whether or not an error has occurred.

(3) Output at error

Set the value to be output when an error occurs.

6-1	
OUT1	ACT: Reverse
	RST: 0.0%
	ERR: 0.0%
	CYC: 30s

Setting range 0.0 to 100.0%

Initial value 0.0%

Note

- ◆ In ON-OFF control (P=OFF), when output at error is set to 50% or more, the actual output at reset becomes 100%.
When output at reset is set to 49.9% or less, the actual output at error becomes 0%.
- ◆ Output at reset is given priority when an error has occurred at Reset State.

(4) Proportional cycle time

Set the proportional cycle time.

This setting item is for the contact and SSR drive voltage output specification.

The screen is not displayed in the case of the current and voltage output specification.

6-1	
OUT1	ACT: Reverse
	RST: 0.0%
	ERR: 0.0%
	CYC: 30s

Setting range 1 to 120s

Initial value 30s: Contact output (Y)
3s: SSR drive output (P)

Note

- ◆ If a short time is set as the proportional cycle time in contact output, the contact life of the output relay may be adversely affected.
Pay particular attention to this point when setting the proportional cycle time.
- ◆ If a long time is set as the proportional cycle time in a control system with a short delay time, the control result will be adversely affected.
- ◆ The proportional cycle time cannot be set during execution of auto tuning (AT) or ramp control action.

(5) Setting output 2

This setting item is available only when the 2-output specification is selected, and is not displayed for a 1-output specification.

The setup method and cautions for parameters are the same as those for Output 1.

6-1	
OUT2	ACT: Reverse
	RST: 0.0%
	ERR: 0.0%
	CYC: 30s

	Setting range	Initial value
ACT	:Reverse, Direct	Direct
RST	:0.0 to 100.0%	0.0%
ERR	:0.0 to 100.0%	0.0%
CYC	:1 to 120s	Contact output (Y) 30s SSR drive output (P) 3s

8-4 Setting the Ten-Segment Linearizer Approximation

(1) Enabling ten-segment linearizer approximation

This function performs linearization based upon ten-segment approximation when the PV input is a non-linear signal.

This item is set during voltage input and current input.

The screen is not displayed during RTD and TC input.

7-4
PMD OFF

Setting range ON, OFF
Initial value OFF

(2) Setting input points

Set the input points in the case of ten-segment linearizer approximation input. Set PV display value (B) to PV input value (A).

When the value of B is smaller than the value of the previous A, values of B from then onwards are invalid.

7-4
PMD : ON
A 1 0.00%
B 1 : 0.00%

}

7-9
A 10 0.00%
B 10 : 0.00%
A 11 : 0.00%
B 11 : 0.00%

Up to 11 points can be set. 11 points (B1 to B11) can be set for PV display (%) on PV 11 inputs (A1 to A11). For each input point, B1 is set to A1, B2 for A2 and so forth until B11 is set to A11, and linear interpolation is executed between input points.

This item is set during voltage input and current input.

The screen is not displayed during RTD and TC input.

Setting range An, Bn: -5.00 to 105.00%
Initial value An, Bn: 0.00%

■ Ten-segment linearizer setting (example)

In the following figure, A1, B1 to A6, B6 are used to set input points with four intermediate points.

For before A1 and from A6 onwards, the ramps of (A1, B1) to (A2, B2) and the ramps of (A5, B5) to (A6, B6) are applied.

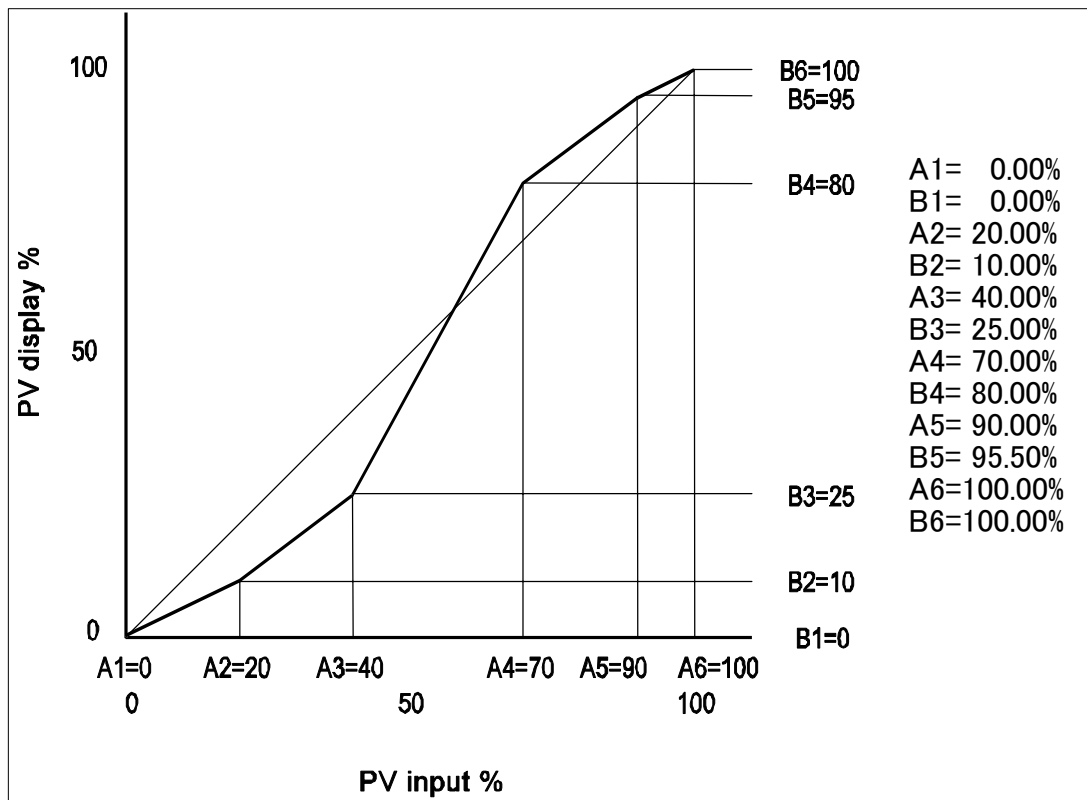

Caution

- ◆ Set so that the relationship $A_n < A_{(n+1)}$ is satisfied. When the relationship becomes $A_n \geq A_{(n+1)}$, $A_{(n+1)}$ onwards becomes invalid.

8-5 Limiters

(1) Output rate-of-change limiter

Set this setting item when a control target that is adverse to sudden changes in output is used.

The rate-of-change limiter can be set to each of Output 1 (OUT1) and Output 2 (OUT2 is displayed only in the 2-output specification device).

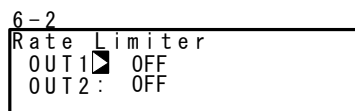

Setting range

OUT1, OUT2: OFF, 0.1 to 100.0 %/s

Initial value

OUT1, OUT2: OFF

(2) SV limiter

The SV limit is used to prevent a wrongful setting. Set the lower limit value and higher limit value of the SV value setting range.

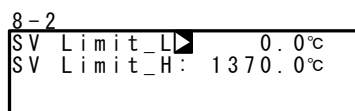

Setting range

Within measuring range
SV Limit L < SV Limit H)

Initial value

SV Limit_L Lower limit value of measuring range

SV Limit_H Higher limit value of measuring range

If the preset SV value (FIX SV, Start SV, STEP SV) exceeds the SV limit, the SV value will be displayed inverted in white as shown below, and the SV value will be replaced internally with the limiter value, and the limit-cut SV value will be displayed on the SV display.

Ex) When FIX SV value is set to 400.0°C with RANGE 04(K1) –100.0 to 400.0°C, and then SV Limit_H is set to 350.0°C

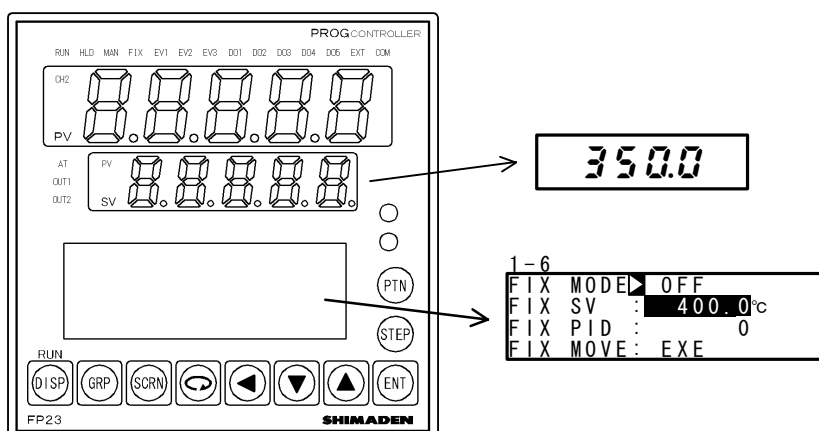

The white-inverted section indicates limiter over.

8-6 Compensating Control Output/Analog Output

Error that occurs in control output (at linear output) or analog output can be compensated.

1. Release the key lock if it is applied.
For details on how to release the key lock, see "6-2 Releasing the Key Lock."
2. Set controller control action to the stop mode (reset).
For details on control stop operation, see "4-1 Control Modes."

3. Set the count value.
Call up the LOCK, etc. top screen (group 8) from the basic screen by the **GRP** key.

Move to the setup screen by holding down the **ENT** key and pressing the **GRP** key for at least 3 seconds, and select the output to compensate by pressing the **SCRN** and **↺** keys. Set the count value currently displayed on the SV display with the **▼** or **▲** key, and press the **ENT** key to fix and register settings

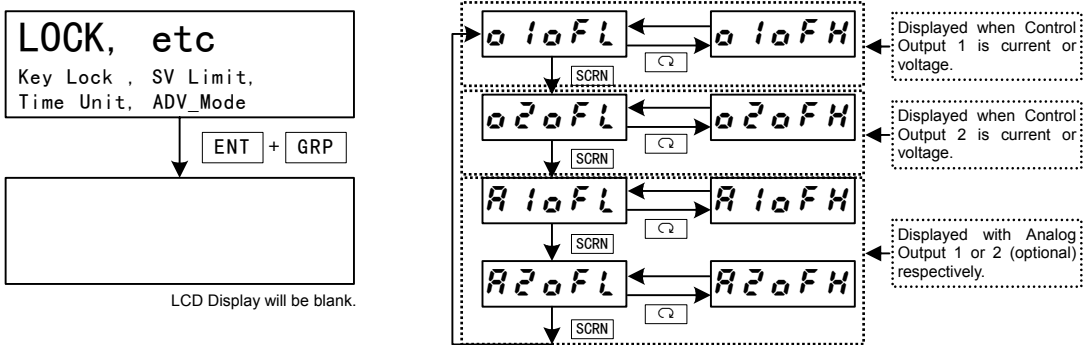

PV Display	Description	PV Display	Description
<i>o1oFL</i>	Control Output 1 lower limit value	<i>o1oFH</i>	Control Output 1 higher limit value
<i>o2oFL</i>	Control Output 2 lower limit value	<i>o2oFH</i>	Control Output 2 higher limit value
<i>A1oFL</i>	Analog Output 1 lower limit value	<i>A1oFH</i>	Analog Output 1 higher limit value
<i>A2oFL</i>	Analog Output 2 lower limit value	<i>A2oFH</i>	Analog Output 2 higher limit value

When "0" is set, settings return to factory defaults.

4. When you have finished setting the above, press the **DISP** key to return to the LOCK, etc. screen.

9 PROGRAM SETTINGS

9-1 Program Initial Settings

(1) Time unit

Set the unit of time that is currently used in various items such as step time or time signal. Set control action to Reset State before performing this operation.

8-3	Setting range	H/M, M/S
Time Unit: <input type="checkbox"/> H/M	Initial value	H/M
PRG. Wait : 00h00m		
SO Mode : HLD		
POWER ON : RESET		

H/M hours/minutes
M/S minutes/seconds

(2) Program start delay time

The delay time until start of program control execution can be set. The time unit is fixed to H/M.

The RUN lamp blinks for that duration that the delay time is active after program control execution is started.

Program control is started, and the RUN lamp lights after the preset delay time has elapsed.

8-3	Setting range	00h00m to 99h59m
Time Unit: H/M	Initial value	00h00m
PRG. Wait: <input checked="" type="checkbox"/> 00h00m		
SO Mode : HLD		
POWER ON : RESET		

(3) Input error mode

Set processing when a sensor breaks or a scale over or other error occurs during program control.

8-3	Setting range	HLD, RUN, RESET
Time Unit: H/M	Initial value	HLD
PRG. Wait : 00h00m		
SO Mode: <input checked="" type="checkbox"/> HLD		
POWER ON : RESET		

- HLD** Sets a hold state until the device is restored from scale over or a reset is performed. Note, however, that this differs from a regular hold state in that the setting value of the output at error continues to be output. For details, see "8-3 (3) Output at error."
- RUN** Program action continues until the end of the program or a reset is input. Note, however, that this differs from a regular RUN state in that the setting value of the output at error continues to be output. For details, see "8-3 (3) Output at error."
- RESET** Releases and resets program operation.

(4) Power failure compensation

Set in which state of the device is to be restored when the power is turned ON again after a power failure during program execution.

```

8-3
Time Unit: H/M
PRG. Wait : 00h00m
SO Mode   : HLD
POWER ON  ▶ RESET

```

Setting range RESET, CONTINUE
Initial value RESET

- RESET During Program control, the state that was active before the power fail is not held, and the device is reset when the power is turned ON again.
- CONTINUE During Program control, the state that was active before the power interrupt is held. (During FIX control, the state that was active before the power interrupt is held at all times.)
Excluding the following:
1. AT execution
2. Change in state of DI input
3. PID No. when the hysteresis of zone PID is taken into consideration

(5) Advance mode

Set the details of advance operation.

For details on advance operation, refer to "16-5 Executing Advance (ADV)

```

8-4
ADV Mode▶ Step
ADV Time: 00h00m

```

Setting range Step, Time
Initial value Step

- Step Advances the program by steps.
- Time Advances the program by time.
When there is a part that exceeds the step width time in the time set here, that part becomes invalid, and the program advances to the start of the next step immediately when the step width time is exceeded.

(6) Advance time

Set the advance time when the advance mode is set to [Time].

```

8-4
ADV Mode: Time
ADV Time▶ 00h00m

```

Setting range 00:00 to 99:59
Initial value 00:00

Note

- ◆ When "00:00" is set, time advance does not function.

9-2 Step-related Settings

Make settings for each step.

The following describes setup operation using start pattern 1 and step 1 as an example.

(1) Step SV value

Set the SV value of step 1.

2S-1			
PTN			
01	SV	▶	0.0°C
STEP	Time	:	00h01m
001	PID	:	0

Setting range

Within SV limiter setting range

Initial value

0.0

Note

2S-1			
PTN			
01	SV	▶	400.0°C
STEP	Time	:	00h00m
001	PID	:	0

- ◆ When the STEP SV value exceeds the limit, the SV value is highlighted as shown left side.
- ◆ The SV value displayed reversed in white is replaced internally with the limiter value, and the SV value cut by the limiter is displayed on the SV display.
- ◆ For details, see "8-5 (2) SV limiter."

(2) Step Time

Set the time of step 1.

2S-1			
PTN			
01	SV	:	0.0°C
STEP	Time	▶	00h01m
001	PID	:	0

Setting range

00:00 to 99:59

Initial value

00:01

(3) Step PID No.

Set the PID No. of step 1 execution.

2S-1			
PTN			
01	SV	:	0.0°C
STEP	Time	:	00h01m
001	PID	▶	0

Setting range

0 to10

Initial value

0

When PID=0 is set, the previous execution step PID No. is looked up.

When PID=0 is set to the start step, the program is executed by PID No.1 at the start of the program.

9-3 Pattern-related Settings

(1) Number of steps

Set the number of steps to be used in the program pattern.

```

2-1
PTN
01
  Num. of STEP: 20
  Start STEP : 1
  
```

Setting range 0 to 400
Initial value PTN1: 20
 Other: 0

Set control action to a stopped (reset) state before performing this operation.

(2) Start step

Set the step at program start.

```

2-1
PTN
01
  Num. of STEP: 20
  Start STEP : 1
  
```

Setting range 0 to number of steps
Initial value PTN1: 1
 Other: 0

When "0" is set, that pattern becomes invalid.

Note

- ◆ This parameter can also be set before execution of program control in the basic screen. For details, see "15-1 Operations in Basic Screen."

(3) Start SV

Set the SV value at start of the program.

The start SV function is enabled only when the program is started from step 1.

```

2-2
PTN
01
  Start SV: 0.0°C
  PTN Repr: 1
  
```

Setting range Within SV limiter setting range
Initial value 0.0

Note

```

2-2
PTN
01
  Start SV: 400.0°C
  PTN Repr: 1
  
```

- ◆ When the Start SV value exceeds the limit, the SV value is highlighted as shown left side.
- ◆ The highlighted SV value is replaced internally with the limiter value, and the SV value cut by the limiter is displayed on the SV display.
- ◆ For details, see "8-5 (2) SV limiter."

(4) Pattern execution count

Set the execution count of the program pattern. When a pattern execution count smaller than the current execution count is set during program execution, the program pattern ends after execution up to the end step. (If the pattern is linked, the program moves to the next pattern.)

```

2-2
PTN
01
Start SV: 0.0°C
PTN Repl 3
    
```

Setting range 1 to 9999
Initial value 1

Ex) When the pattern execution count is set to "3" at PTN1 (from step 1 to 4)

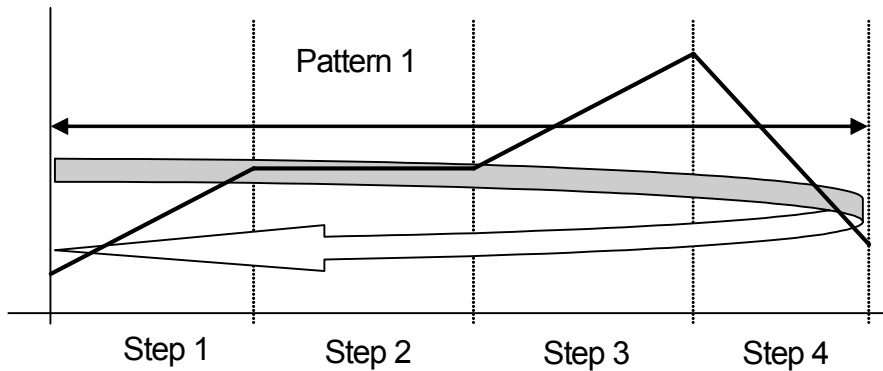

PTN 1 is executed three times.

(5) Start step No. of step loop

Set the start step No. during step loop.

```

2-3
PTN Loop Setup
01 Start 1
End : 1
Reps : 1
    
```

Setting range 1 to number of steps
Initial value 1

(6) End step No. of step loop

Set the end step No. during step loop.

```

2-3
PTN Loop Setup
01 Start : 1
End 1
Reps : 1
    
```

Setting range 1 to number of steps
Initial value 1

(7) Execution count of step loop

Set the execution count of the step loop.

2-3		
PTN	Loop Setup	
01	Start :	2
	End :	5
	Reps	3

Setting range 1 to 9999

Initial value 1

Ex) When execution count is set to "3" at start step No.2 and end step No.5

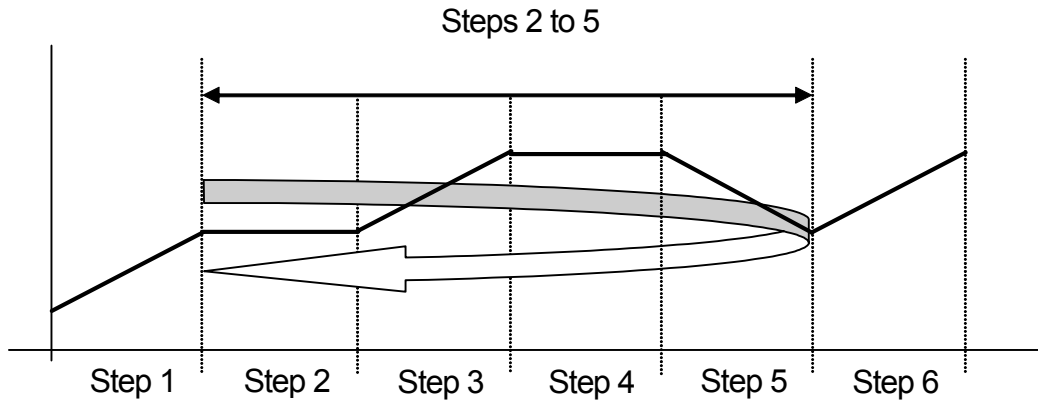

Steps 2 to 5 are executed 3 times.

(8) Guarantee soak zone

Set the guarantee soak zone (hysteresis of guarantee soak function).

Set the setting value as a deviation with respect to the SV value of a flat step.

2-4		
PTN	GUArantee Soak	
01	Zone	OFF
	Time	:00h00m
	PV Start	OFF

Setting range OFF, 1 to 9999

Initial value OFF

What is the guarantee soak (GUA) function?

During program control, when the SV value migrates from a ramp step to a flat step, the PV value sometimes can no longer track the SV value and the flat step time may become shorter on some control systems. This function is for avoiding this and assuring the time of the flat step.

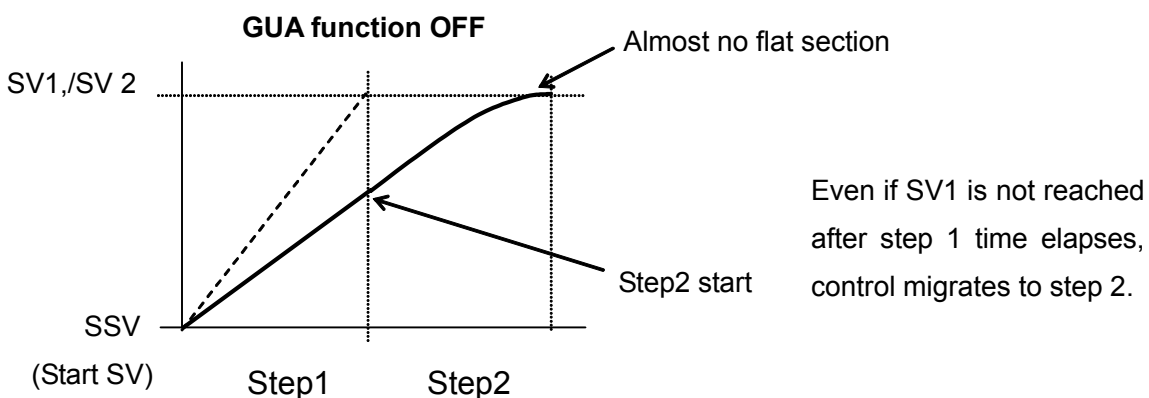

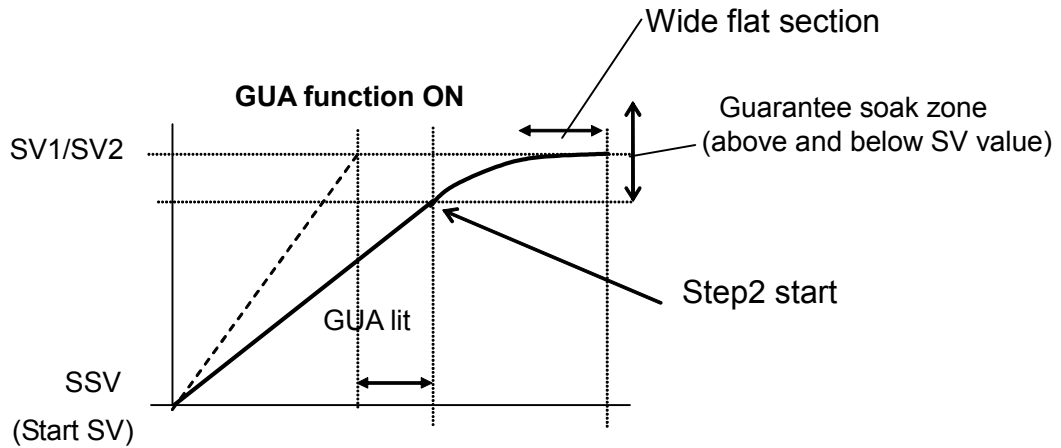

When the deviation between the step SV and PV of the flat step does not enter the guarantee soak zone when the ramp step switches to the flat step, the program does not move to the next step, and program execution stands by until this region is reached or the GUA time ends.

In this standby state, the GUA lamp lights in the status monitor screen (0-2).

Note

- ◆ Even if step 1 is flat (SSV = SV1) when the RST mode changes to the PROG mode, guarantee soak is performed.
- ◆ Even in steps where the step time is set to "00:00", guarantee soak is performed if the guarantee soak conditions are satisfied.

(9) Guarantee soak time

Set the guarantee soak time. Time measurement is performed at the same time that the ramp step time ends, and the program moves to the flat step regardless of whether the PV value is inside or outside the zone when the preset time is reached.

Note, however, that when "00: 00" is set, GUA continues until PV reaches the zone.

2-4	
PTN	GUArantee Soak
01	Zone: OFF
	Time: 00h00m
	PV Start: OFF

Setting range 00:00 to 99:59
Initial value 00:00

(10) PV start

When the start step at program execution is ramp control, and the value of difference between start SV value and PV value is larger, dead time occurs. To omit this dead time, set the PV value for the purpose of starting as the start SV. When PV start is OFF, execution starts from the start SV at all times.

2-4	
PTN	GUArantee Soak
01	Zone: OFF
	Time: 00h00m
	PV Start: OFF

Setting range ON/OFF
Initial value OFF

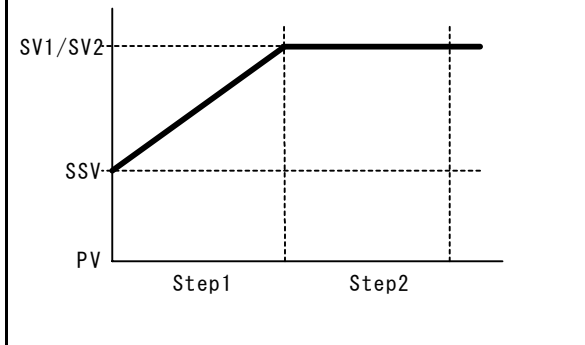
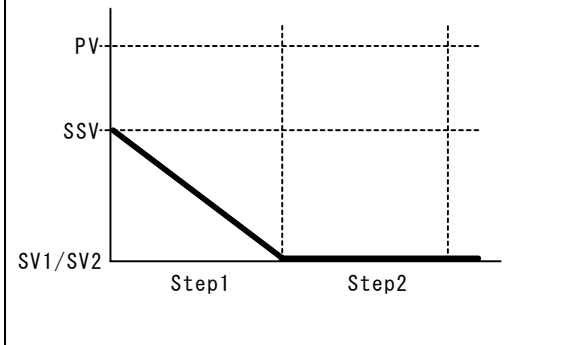
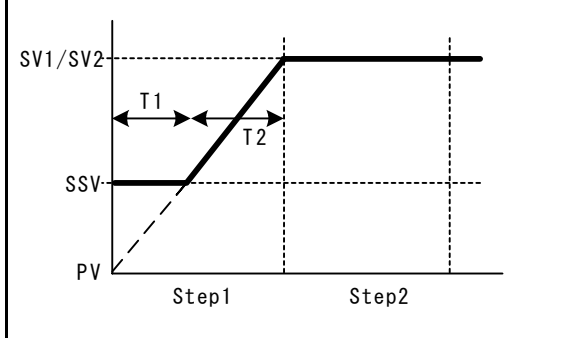
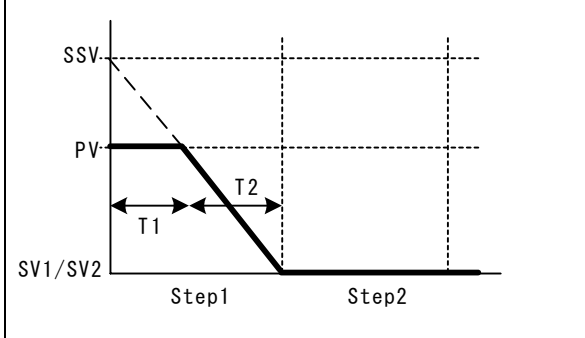
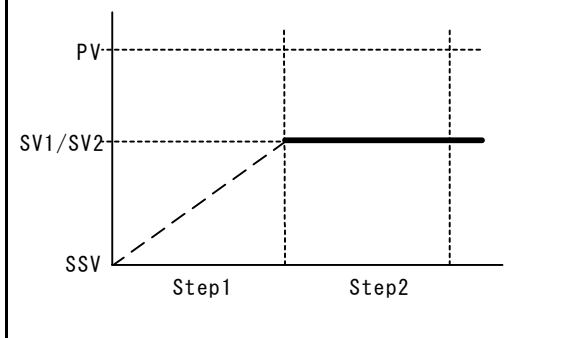
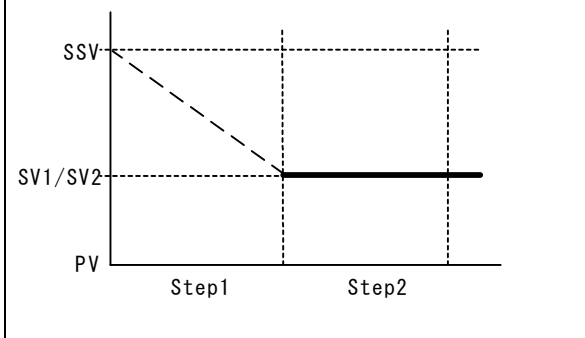
<p>① $PV \leq SSV < SV1$</p> 	<p>④ $PV \geq SSV > SV1$</p> 
<p>② $SSV < PV \leq SV1$</p>  <p>T1: The time in this period is shortened to become PV start. T2: Step1 time to be executed</p>	<p>⑤ $SSV > PV \geq SV1$</p>  <p>T1: The time in this period is shortened to become PV start. T2: Step1 time to be executed</p>
<p>③ $SSV < SV1 < PV$</p>  <p>In this case, the program advances to step 2, and step 1 is omitted.</p>	<p>⑥ $SSV > SV1 > PV$</p>  <p>In this case, the program advances to step 2, and step 1 is omitted.</p>

*1 PV start is enabled only when the start step time is set to "00m01s" or more.

*2 Cautions in ② and ⑤ action

Due to the relationship with the device's internal resolution, an accurate SSV (start SV value) might not be calculated when the PV start function is started up by conditions such as a large step SV rate-of-change.

9-4 Pattern Link-related Settings

(1) Setting the pattern link execution count

Set the number of times that pattern link is executed.

1-3	
PTN Link Repls	0
Link Format	
1st: 3	3rd: 4
2nd: 1	4th: 6

Setting range 0 to 9999

Initial value 0

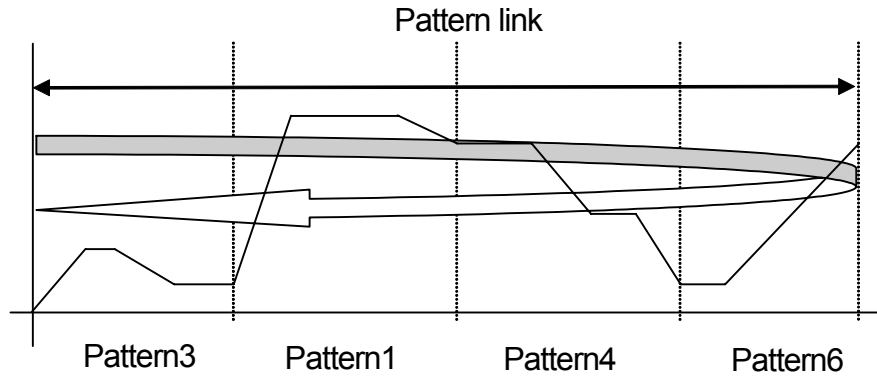

Note

- ◆ When "0" is set to the pattern link execution count, the link function is disabled.

(2) Pattern link

This setting is for linking (connecting) and operating each pattern by a program.

Set the pattern No. to be linked in order from 1st pattern.

Up to 20 patterns can be linked from 1st to 20th.

The same pattern can also be set repeatedly.

1-3	
PTN Link Repls:	1
Link Format	
1st: 3	3rd: 4
2nd: 1	4th: 6

Setting range 0 to higher limit of assigned pattern

Initial value 0

Note

- ◆ When pattern 0 is set, the link to patterns set from then onwards becomes invalid.

9-5 Settings Before Program Operation

(1) Auto-tuning point

To avoid hunting resulting from limit cycle with SV value in executing Auto Tuning, set a hypothetical SV value to carry out Auto Tuning at a point away from the actual SV value.

3-22
 AT Point ▾ 0.0°C

Setting range 0, 1 to 10000 Unit
 Initial value 0

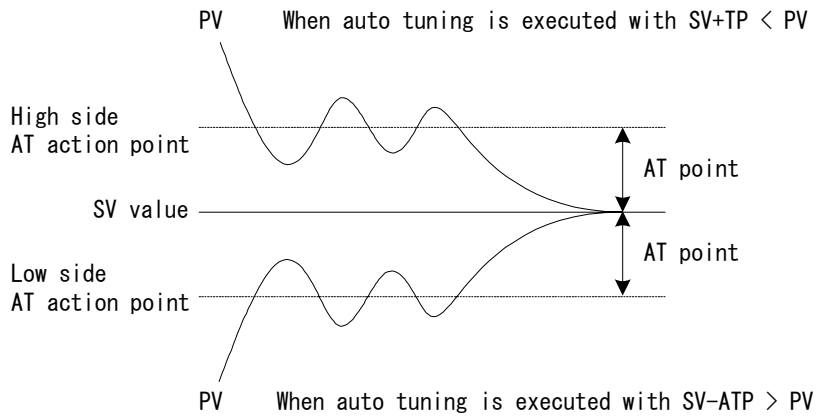

Note

- ◆ For ATP (AT point), set the AT action points above and below the SV as a deviation.
- ◆ When auto tuning is executed with PV outside of the preset AT points above and below, auto tuning is performed at an AT point between PV and SV.
- ◆ When auto tuning is executed with the PV value inside the At action points above and below, auto tuning is performed using the SV value.
- ◆ When ATP is set to "0", the SV value becomes the AT action points.
- ◆ When zone PID SV is selected, AT points become invalid.

(2) Program EVENT/DO action points

Set the action points of each of EVENT/DO in the Program mode.

This screen is not displayed when an action other than the six actions shown below is set to EVENT/DO.

2-5

PTN	EV	Set	Point
01	EV1	HD	2500.0℃
	EV2	LD	-2500.0℃
	EV3	HD	2500.0℃

2-6

PTN	DO	Set	Point
01	D01	HD	2500.0℃
	D02	LD	-2500.0℃
	D03	HD	2500.0℃

2-7

PTN	DO	Set	Point
01	D04	HD	2500.0℃
	D05	LD	-2500.0℃

2-8

PTN	DO	Set	Point
01	D06	HD	2500.0℃
	D07	LD	-2500.0℃

2-9

PTN	DO	Set	Point
01	D08	HD	2500.0℃
	D09	LD	-2500.0℃

2-10

PTN	DO	Set	Point
01	D010	HD	2500.0℃
	D011	LD	-2500.0℃

2-11

PTN	DO	Set	Point
01	D012	HD	2500.0℃
	D013	LD	-2500.0℃

Setting range

HD (DEV Hi)	Higher limit deviation	-25000 to 25000 Unit
LD (DEV Low)	Lower limit deviation	-25000 to 25000 Unit
OD (DEV Out)	Outside higher/lower limit deviation value	0 to 25000 Unit
ID (DEV In)	Inside higher/lower limit deviation value	0 to 25000 Unit
HA (PV Hi)	PV higher limit absolute value	Within measuring range
LA (PV Low)	PV lower limit absolute value	Within measuring range

Initial value

HD (DEV Hi)	Higher limit deviation value	25000 Unit
LD (DEV Low)	Lower limit deviation value	-25000 Unit
OD (DEV Out)	Outside higher/lower limit deviation value	25000 Unit
ID (DEV In)	Inside higher/lower limit deviation value	25000 Unit
HA (PV Hi)	PV higher limit absolute value	Within measuring range (higher limit value)
LA (PV Low)	PV lower limit absolute value	Within measuring range (lower limit value)

(3) Time signal (TS)

Eight time signals are available for each pattern.

The following screen descriptions are for Time Signal 1 (TS1).

To use a time signal as an external output, TS1 to TS8 must be assigned to EV1 to EV3 and DO1 to DO13 in the EVENT/DO screen group.

■ Time signal enabling conditions

Though invalid conditions can be assigned, they do not function.

1) The ON step No. must already be set (must not be OFF).

2) The ON step No. \leq the OFF step No.

Note, however, that the actual ON time \leq the actual OFF time.

- ◆ When the ON step No. = OFF step No.

TS turns ON for 1 second when the actual ON time = actual OFF time

- ◆ When the ON step No. < OFF step No.

TS turns ON for 1 second when the actual ON time = actual OFF time

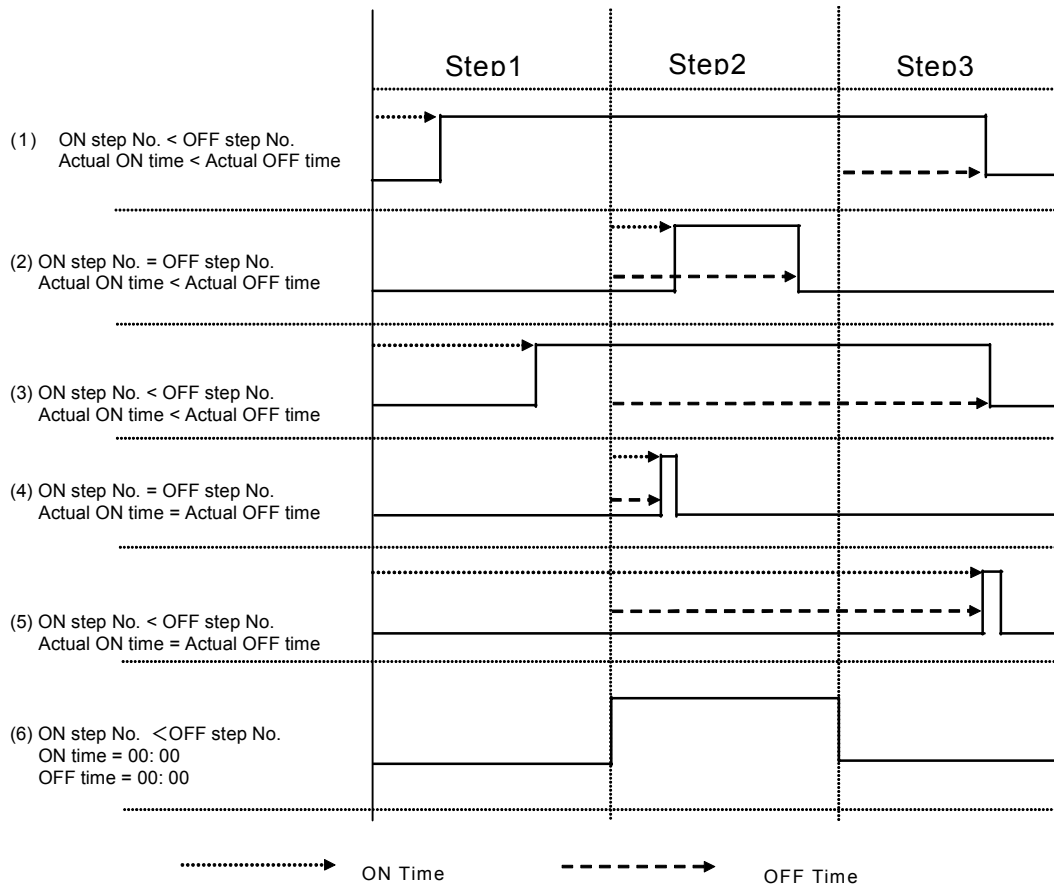

Actual ON time: the time until Time Signal will be ON after the program has started

Actual OFF time: the time until Time Signal will be OFF after the program has started

ON time: Time signal ON time

OFF time: Time signal OFF time

< Other precautions relating to setting >

- (1) The Time Signal (TS) tick is suspended during a Hold or Guarantee Soak.
- (2) If TS turns ON when the OFF step assigned is OFF with the ON step and ON time both enabled, TS stays ON until the end of the pattern.
- (3) When the OFF step or actual OFF time exceeds the end step time, TS output becomes OFF at the end of the pattern end step.
Note, however, that it becomes ON when the ON time at the next pattern is 00:00.
- (4) When the ON time = step time, TS turns ON at the start of the next step.
(including OFF time)
- (5) When TS values have been changed in a Hold state during program execution, the values will not be updated until after the hold state is released.

① Time signal ON step No.

Set the step No. at which Time signal 1 (TS1) turns ON.

2-12

PTN	ON	STEP	OFF
01	ON	Time	:00h00m
	OFF	STEP	: OFF
TS1	OFF	Time	:00h00m

Setting range OFF, 1 to number of steps
Initial value OFF

② Time signal ON time

Set the time from the start of the step at which Time signal 1 (TS1) turns ON up to when the signal actually turns ON.

2-12

PTN	ON	STEP	: OFF
01	ON	Time	:00h00m
	OFF	STEP	: OFF
TS1	OFF	Time	:00h00m

Setting range 00:00 to 99:59
Initial value 00:00

③ Time signal OFF step No.

Set the step No. at which Time signal 1 (TS1) turns OFF.

2-12

PTN	ON	STEP	: OFF
01	ON	Time	:00h00m
	OFF	STEP	: OFF
TS1	OFF	Time	:00h00m

Setting range OFF, 1 to number of steps
Initial value OFF

④ Time signal OFF time

Set the time from the start of the step at which Time signal 1 (TS1) turns OFF up to when the signal actually turns OFF

2-12

PTN	ON	STEP:	OFF
01	ON	Time:	00h00m
	OFF	STEP:	OFF
TS1	OFF	Time	00h00m

Setting range 00:00 to 99:59

Initial value 00:00

(4) Start pattern No.

Set the start pattern No. when executing a program.

This screen belongs not to PROGRAM (program screen group) but to CTRL EXEC (execution screen group).

1-2

HLD:	OFF
ADV:	OFF
Start PTN	1

Setting range 1 to higher limit of assigned pattern

Initial value 1

Note

- ◆ This pattern can also be set before program control execution in the basic screen. For details, see "15-1 Operations in Basic Screen."

10 FIX SETTINGS

10-1 Switching the FIX Mode

The FP23 can be set to the FIX (fixed value control) mode.

Note that movement to the FIX mode when the Program mode is switched to the FIX mode varies according to the FIX MOVE setting.

For details, see "10-4 FIX MOVE".

1-6	<pre> FIX MODE: OFF FIX SV : 0.0°C FIX PID : 1 FIX MOVE: EXE </pre>	Setting range	ON,OFF
		Initial value	OFF

ON FIX (fixed value control) mode

OFF Program mode

Note

- ◆ Switching between the Program mode and the FIX mode is also possible in the basic screen.

10-2 FIX SV Value

Set the SV value during fixed value control (FIX mode: ON).

1-6	<pre> FIX MODE: OFF FIX SV : 0.0°C FIX PID : 1 FIX MOVE: EXE </pre>	Setting range	Within SV limiter setting range
		Initial value	0 Unit

Note

1-6	<pre> FIX MODE: OFF FIX SV : 400.0°C FIX PID : 1 FIX MOVE: EXE </pre>
-----	---

- ◆ When the FIX SV value exceeds the limit, the SV value is highlighted as left side.
- ◆ The highlighted SV value is replaced internally with the limiter value, and the SV value cut by the limiter is displayed on the SV display.
- ◆ For details, see "8-5 (2) SV limiter."

10-3 FIX PID No.

Set the PID No. during fixed value control (FIX mode: ON).
The PID No. cannot be set when Zone PID is enabled. ("Zone" is displayed.)

```

1-6
FIX MODE: OFF
FIX SV : 0.0°C
FIX PID ▣ 1
FIX MOVE: EXE

```

Setting range 1 to 10

Initial value 1

10-4 FIX MOVE

Make detailed settings for when the FP23 enters FIX mode.

```

1-6
FIX MODE: OFF
FIX SV : 0.0°C
FIX PID 1
FIX MOVE ▣ EXE

```

Setting range EXE, EXE/STBY, EXE/TRCK

Initial value EXE

- EXE Switch to RUN state when transferring to FIX mode.
- EXE/STBY Current (RUN/RST) state is maintained when transferring to FIX mode.
- EXE/TRCK In case of RST state, switch to RUN state when transferring to FIX mode.
In case of RUN state, track the SV and PID No. that have been used just before, and switch to RUN state.

FIX MOVE	Before Move → After Move	Remarks
EXE	PRG RST → FIX RUN	Enters the RUN mode.
	PRG RUN → FIX RUN	Stays in the RUN mode.
EXE/STBY	PRG RST → FIX RST	Stays in the RST mode.
	PRG RUN → FIX RUN	Stays in the RUN mode.
EXE/TRCK	PRG RST → FIX RUN	Enters the RUN mode.
	PRG RUN → FIX RUN	Executing SV value and PID values are tracked.

Note

- ◆ When the FP23 moves from FIX mode to the Program mode, the FP23 maintains its current state (RUN or Reset).

10-5 FIX EVENT/DO Action Points

Set each of the EVENT/DO action points in the FIX mode.

This screen is not displayed when a mode other than the six actions shown below is set to EVENT/DO.

1-7

FIX	EV	Set	Point
EV1	HD	2500.0	°C
EV2	LD	-2500.0	°C
EV3	HD	2500.0	°C

1-8

FIX	DO	Set	Point
D01	HD	2500.0	°C
D02	LD	-2500.0	°C
D03	HD	2500.0	°C

1-9

FIX	DO	Set	Point
D04	HD	2500.0	°C
D05	HD	2500.0	°C

1-10

FIX	DO	Set	Point
D06	HD	2500.0	°C
D07	HD	2500.0	°C

1-11

FIX	DO	Set	Point
D08	HD	2500.0	°C
D09	HD	2500.0	°C

1-12

FIX	DO	Set	Point
D010	HD	2500.0	°C
D011	HD	2500.0	°C

1-13

FIX	DO	Set	Point
D012	HD	2500.0	°C
D013	HD	2500.0	°C

Setting range

HD (DEV Hi)	Higher limit deviation	-25000 to 25000 Unit
LD (DEV Low)	Lower limit deviation	-25000 to 25000 Unit
OD (DEV Out)	Outside higher/lower limit deviation value	0 to 25000 Unit
ID (DEV In)	Inside higher/lower limit deviation value	0 to 25000 Unit
HA (PV Hi)	PV higher limit absolute value	Within measuring range
LA (PV Low)	PV lower limit absolute value	Within measuring range

Initial value

HD (DEV Hi)	Higher limit deviation value	25000 Unit
LD (DEV Low)	Lower limit deviation value	-25000 Unit
OD (DEV Out)	Outside higher/lower limit deviation value	25000 Unit
ID (DEV In)	Inside higher/lower limit deviation value	25000 Unit
HA (PV Hi)	PV higher limit absolute value	Within measuring range (higher limit value)
LA (PV Low)	PV lower limit absolute value	Within measuring range (lower limit value)

11 PID SETTING

11-1 Proportional Band (P)

"Proportional band" refers to the range in which control output changes in proportion to the difference (deviation) between the measured value (PV) and the set value (SV). Here, set the percentage (%) that control output is made to change with respect to the measuring range.

When a wide proportional band is set, the change in the control output with respect to deviation decreases, and the offset (constant deviation) increases.

When a narrow proportional band is set, the change in the control output increases, and the offset decreases. If too narrow a proportional band is set, hunting (vibration) occurs, and action becomes similar to that of ON-OFF control.

When P=OFF is set, control becomes ON-OFF control, and auto tuning cannot be executed.

3-1

PID01-OUT1			
P	3.0%	MR:	0.0%
I	120s	SF:	0.40
D	30s		

Setting range	OFF, 0.1 to 999.9 %
Initial value	3.0 %

11-2 Integral Time (I)

Integral action is a function for correcting the offset (constant deviation) that occurs due to proportional action.

When a long integral time is set, offset correction action is weak, and it takes a long time to correct the offset. The shorter an integral time is set, the stronger the correction action becomes. However, if too short an integral time is set, hunting (vibration) occurs, and action becomes similar to that of ON-OFF control.

3-1

PID01-OUT1			
P	3.0%	MR:	0.0%
I	120s	SF:	0.40
D	30s		

Setting range	OFF, 1 to 6000 s
Initial value	120 s

When auto tuning is executed with I=OFF, the manual reset (MR) value is computed and automatically set.

For details on automatic setting of MR, see "11-4 Manual Reset (MR)."

11-3 Derivative Time (D)

Derivative action functions in two ways. It forecasts changes in the control output to reduce influence caused by external disturbance, and suppresses overshoot caused by integral action to improve control stability.

The shorter a derivative time is set, the weaker derivative action becomes. Alternatively, the longer a derivative time is set, the stronger derivative action becomes. However, if too long a derivative time is set, hunting (vibration) occurs, and action becomes similar to that of ON-OFF control.

3-1

PID01-OUT1	
P: 3.0%	MR: 0.0%
I: 120s	SF: 0.40
D: <input checked="" type="checkbox"/> 30s	

Setting range OFF, 1 to 3600 s
Initial value 30 s

When auto tuning is executed with D=OFF, computation is performed only by PI value (proportional, integral).

11-4 Manual Reset (MR)

This function manually corrects offset that occurs when control action is performed by P or P+D (I=0) control.

When a + side MR value is set, the control result shifts to the + side, and when a – MR value is set, the control action shifts to the – side. The amount of shift is proportional to the size of the numerical value that is set.

3-1

PID01-OUT1	
P: 3.0%	MR: <input checked="" type="checkbox"/> 0.0%
I: OFF	SF: 0.40
D: 30s	

Setting range -50.0 to 50.0 %
Initial value 0.0 % (in 1-output specification)
50.0 % (in 2-output specification)

■ Automatic setting of MR

When auto tuning is executed with I=OFF, the manual reset (MR) value is computed and automatically set.

During PID control, MR is used as the target load ratio in PID initial operation.

For this reason, to reduce overshoot when the power is turned ON or when RST is switched to RUN, set a small MR value to lower this target load ratio.

When auto tuning is performed by PID control on the FP23, the load ratio is calculated so that offset is decreased even if there is no I action, and a value corresponding to the manual reset is automatically set.

This function enables control results superior to those enabled by regular PID control to be obtained.

11-5 Action Hysteresis (DF)

This item sets the hysteresis (DF) in ON-OFF control action when P is set to OFF. When a narrow hysteresis is set, chattering is more likely to occur on the output. When a wide hysteresis is set, chattering, etc. can be avoided and stable control action can be obtained.

3-1

PID01-OUT1	
P:	OFF
DF	2.0 °C

Setting range 1 to 9999 Unit
Initial value 20 Unit

11-6 Dead Band (DB)

This setting is for only the 2-output specification. Set the action range of output 2 (OUT2) taking the characteristics of the control target and energy savings into consideration.

PID01-OUT2	
P:	3.0% DB 0.0°C
I:	OFF SF: 0.40
D:	30s

Setting range -19999 to 20000 Unit
Initial value 0 Unit

The patterns in the following figures show the relationship between output action and dead band.

RA: Reverse Action, DA: Direct Action

■ Control output 1:RA, Control output 2: DA (RA+DA)

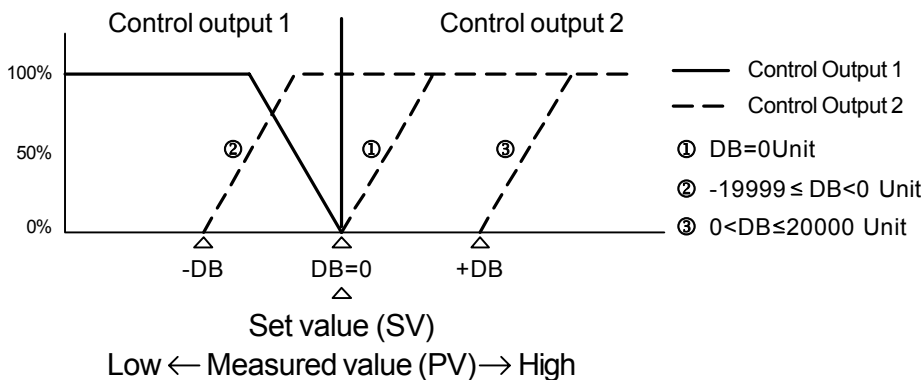

■ Control output 1:RA, Control output 2: RA (RA+RA)

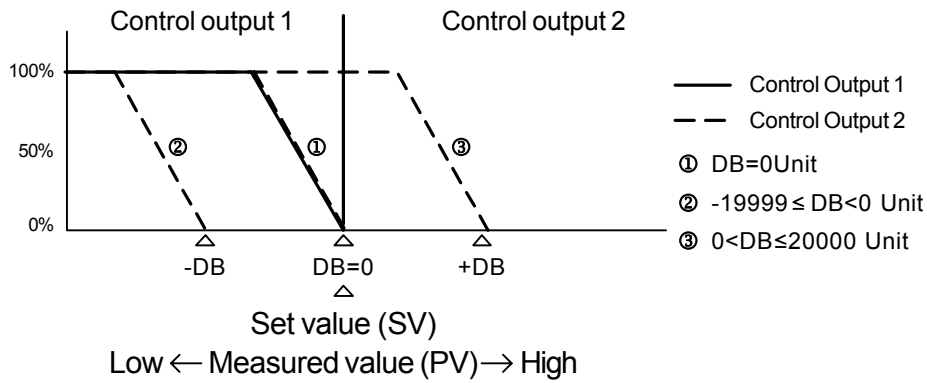

■ Control output 1:DA, Control output 2: RA (DA+RA)

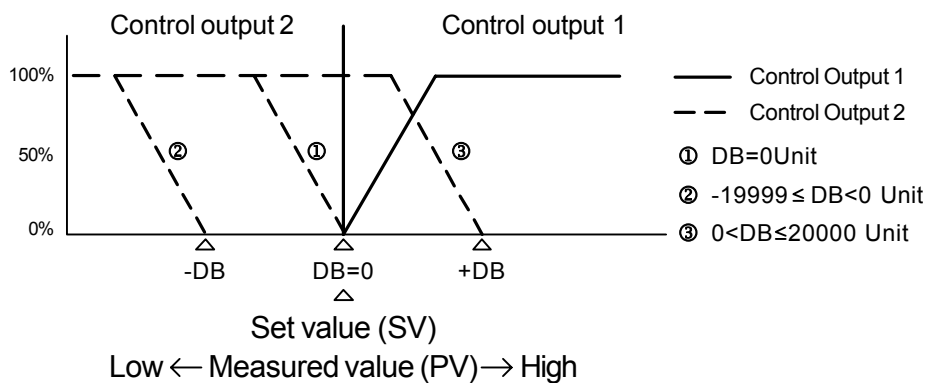

■ Control output 1:DA, Control output 2: DA (DA+DA)

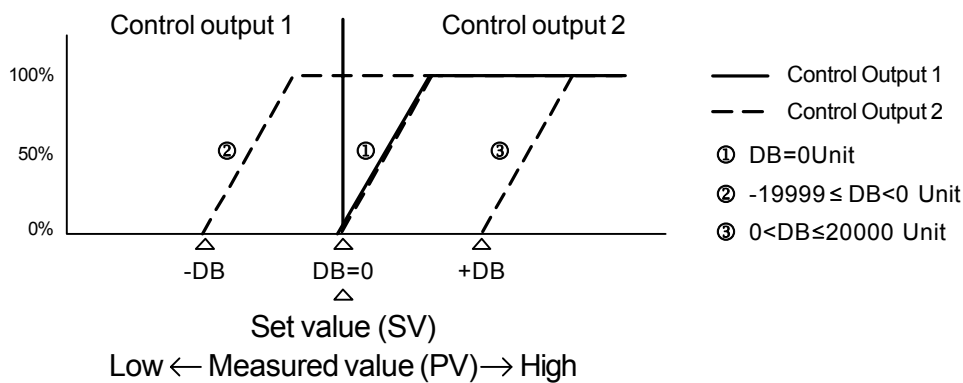

11-7 Set Value Function (SF)

This function determines the strength for preventing overshooting that occurs during Expert PID control.

Set Value Function is valid only when integral action (PI or PID) is set.

3-1

PID01-OUT1	
P: 3.0%	MR: 0.0%
I: OFF	SF <input checked="" type="checkbox"/> 0.40
D: 30s	

Setting range 0.00 to 1.00
Initial value 0.40

- SF = 0.00 Regular PID control is carried out, and the overshoot correction function is disabled.
- SF → Small Overshoot correction is small.
- SF → Large Overshoot correction is large.

■ Reference: About PID action according to set value function (SF)

During a ramp step, PID and PD action can be switched automatically by the SF value. Overshooting in flat steps can be reduced by controlling a ramp step by PD section.

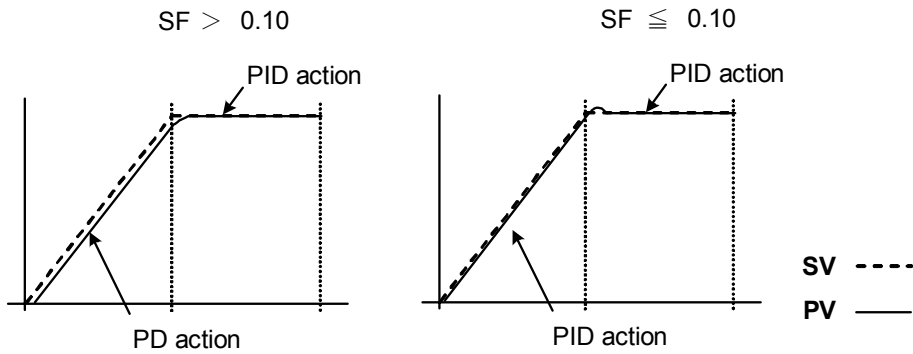

11-8 Output Limit Value (OUT1L to OUT2H)

This is the screen for setting the lower limit value and higher limit value of the control output corresponding to the PID No.

Though regular control is performed using the initial values as they are, these lower limit and higher limit values are used for control that requires higher accuracy.

In a heating control specification, set a lower limit value when the return value is slow arriving due to overshoot at the upper side. For control targets whose temperature immediately drops when the temperature rise is slow and output is lowered.

When the 2-output specification is selected, OUT1 is displayed on the upper row, and OUT2 is displayed on the lower row.

3-2

PID01	OUT1L	0.0%
	OUT1H:	100.0%
	OUT2L:	0.0%
	OUT2H:	100.0%

Setting range

Lower limit value 0.0 to 99.9 %

Higher limit value 0.1 to 100.0 %

(Lower limit value < Higher limit value)

Initial value

Lower limit value 0.0 %

Higher limit value 100.0 %

Note

- ◆ The output limiter is invalid during contact output or SSR drive voltage output when P=OFF is set and ON-OFF control is selected.

11-9 Zone PID

This function sets two or more zones in a measuring range and switches different PID values in each zone for use.

When this function is used, the optimum PID value can be set to each temperature range (zone) so that satisfactory controllability is obtained in a wide temperature range.

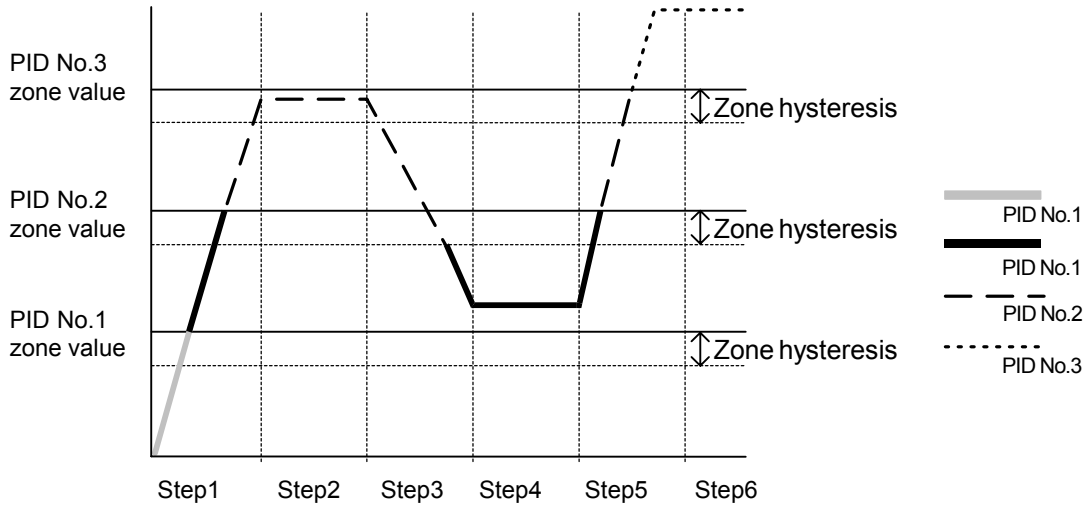

Note

- ◆ When the same zone value is set to multiple PID Nos., the PID No. having the smallest No. is executed.
- ◆ Even if the zone value or zone hysteresis is changed with the SV value inside zone hysteresis, the execution PID No. will not be changed until the SV No. leaves zone hysteresis.

(1) Selecting Zone PID

Select whether or not to use Zone PID.

When this function is used, further select whether to set the zone by SV or by PV.

3-21

Zone PID1	<input type="checkbox"/>	OFF
HYS1	:	2.0

Setting range

OFF, SV, PV

Initial value

OFF

OFF Zone PID function is disabled.

SV Zone PID function of SV is used.

PV Zone PID function of PV is used.

(2) Zone hysteresis

The hysteresis can be set with respect to the zone set value.

This hysteresis is valid for all zone set values.

3-21

Zone PID1	:	ON
HYS1	<input type="checkbox"/>	2.0

Setting range

0 to 10000 Unit

Initial value

20 Unit

(3) PID zone value

Set the zone value (temperature range) to be used by the Zone PID function for each PID No.

3-1

PID01-OUT1			
P:	3.0%	MR:	0.0%
I:	120s	SF:	0.40
D:	30s	ZN	<input type="checkbox"/> 0.0°C

Setting range

Within measuring range

Initial value

0 Unit

Note

- ◆ When the same zone value is set to two or more PID Nos., the PID having the smallest No. is executed.
- ◆ To use the Zone PID function, zone setting and zone hysteresis must be set.

12 EVENT & DO SETTING

12-1 Monitor Screens

(1) DO monitor

4-1

D06	D07	D08	D09
<input type="checkbox"/>	<input type="checkbox"/>	<input type="checkbox"/>	<input type="checkbox"/>
D010	D011	D012	D013
<input type="checkbox"/>	<input type="checkbox"/>	<input type="checkbox"/>	<input type="checkbox"/>

When DOxx (x: 6 to13) turns ON, is highlighted as . DO6 to DO13 are optional, then they are not displayed when they are not installed.

(2) Logic monitor

4-2

EV1	EV2	EV3
B I	F & F	-
D01	D02	D03
B <input checked="" type="checkbox"/>	- -	- -

This screen is displayed when LOGIC is assigned to one or more EVENT/DOS.

LOGIC |: OR &: AND ^: XOR
 Input B: Buffer F: Flip flop I: Inverter

The cursor position is highlighted.

In the screen as above, Buffer and Inverter are assigned to DO1 to make the device perform OR operation on both inputs.

12-2 EVENT/DO Action

Note that if you have changed this setting, action set points (SP) and hysteresis (DF) parameters are initialized.

4-3

EV1	MD <input checked="" type="checkbox"/> None	ACT: N. O.
-----	---	------------

Setting range

Initial value

See "List of EVENT/DO Types".

EV1: DEV Hi

EV2: DEV Low

EV3: RUN

DO 1 to 13: None

■ List of EVENT/DO Types

No.	Mode	Action	No.	Mode	Action
1	None	No action	12	LOGIC	Logic operation (AND/OR/XOR)
2	DEV Hi	Higher limit deviation value		LOGIC	Logic operation (Timer/Count)
3	DEV Low	Lower limit deviation value		Direct	Direct output
4	DEV Out	Outside higher/lower limit deviation	13	RUN	Program/FIX execution
5	DEV In	Inside higher/lower limit deviation	14	HLD	Hold
6	PV Hi	PV higher limit absolute value	15	GUA	Guarantee soak
7	PV Low	PV lower limit absolute value	16	STEP	Step signal
8	SO	Scale over	17	PRG.END	End signal
9	FIX	FIX mode	18 to 25	TS1 to TS8	Time signal 1 to 8
10	AT	Auto tuning execution in progress	26	HBA	Heater break alarm output (option)
11	MAN	Manual operation in progress	27	HLA	Heater loop alarm output (option)

*1 LOGIC operations (AND/OR/XOR) can be assigned only to EV1 to EV3, and DO1 to DO3.

*2 LOGIC operations (Timer/Count) can be assigned only to DO4 and DO5.

*3 Only DO6 to DO13 can be assigned to Direct. The Direct function can be used when the communication option is added on.

■ EVENT/DO Action Diagrams

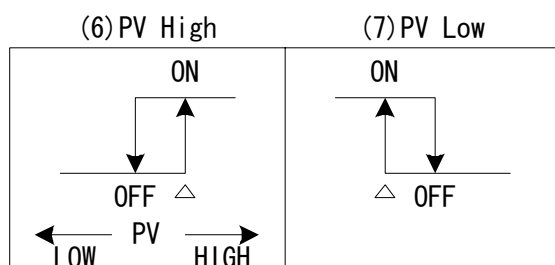
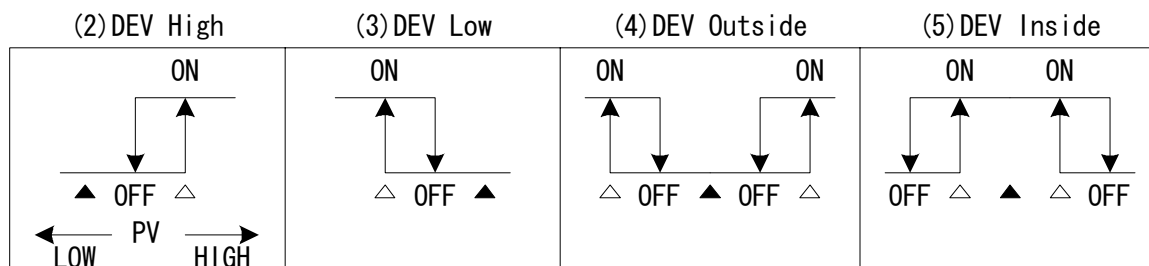

△ Action set point ▲ Set value

* EVENT/DO output conforms to the setting (OPEN/CLOSE) of output characteristics.

■ **EVENT/DO Action in RST State**

When the actions in the table below are assigned to EVENT/DO, EVENT/DO do not function in a Reset (RST) state.

Mode	Action	Mode	Action
DEV Hi	Higher limit deviation value	DEV In	Inside higher/lower limit deviation
DEV Low	Lower limit deviation value	PV Hi	PV higher limit absolute value
DEV Out	Outside higher/lower limit deviation	PV Low	PV lower limit absolute value

(1) **Output characteristics**

4-3
EVT
MD: DEV Low ACT: <input checked="" type="checkbox"/> N.O.
DF: 2.0°C IH: OFF
DLY: OFF

Setting range N.O., N.C.
Initial value N.O.

- N.O.(normally open) When EVENT/DO turns ON, contacts are closed or output transistor turns ON.
- N.C.(normally closed) When EVENT/DO turns ON, contacts are opened or output transistor turns OFF.

(2) **Hysteresis**

Set the hysteresis between ON action and OFF action. Setting hysteresis can avoid chattering, etc., and obtain stable action.

This item is displayed when Modes (2) to (7) are selected in EVENT/DO action.

4-3
EVT
MD: DEV Low ACT: <input checked="" type="checkbox"/> N.O.
DF: 2.0°C IH: OFF
DLY: OFF

Setting range 1 to 9999 Unit
Initial value 20 Unit

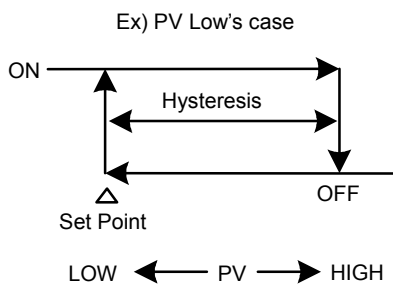

(3) Delay time

This function is for turning EVENT/DO ON after the preset time has elapsed after an EVENT/DO source has been generated.

This item is displayed when Modes (2) to (7) are selected in the EVENT/DO action.

```

4-3
EV1
MD:DEV Low  ACT:N.O.
DF:  2.0°C  IH:OFF
DLY:  OFF

```

Setting range OFF, 1 to 9999 s

Initial value OFF

Note

- ◆ EVENT/DO is not output when the source of the signal output disappears during the delay time. When the source is generated again, counting of the time is performed from the beginning.
- ◆ When the delay time is set to OFF, EVENT/DO is output at the same time that the source of EVENT/DO is generated.
- ◆ When an EVENT/DO source is generated within the delay time operation, the delay time can be changed. Note, however, that the delay time is the time not from when measurement is performed from the newly set time but from the time that was measured from when the output source was generated.

(4) Inhibit Action

This function is for turning EVENT/DO ON when the PV value leaves the EVENT/DO action range and enters the range again without outputting EVENT/DO even if the PV value is in the action range at power ON.

Select this item taking Inhibit Action and event action at scale over into consideration.

This item is displayed when Modes (2) to (7) are selected in the EVENT/DO action.

```

4-3
EV1
MD:DEV Low  ACT:N.O.
DF:  2.0°C  IH:OFF
DLY:  OFF

```

Setting range OFF, 1, 2, 3

Initial value OFF

OFF Inhibit action is not performed.

- 1 Inhibit action is executed at power ON and when the control state changes from RST to RUN.
- 2 Inhibit action is executed at power ON, when the control state changes from RST to RUN, and when the state of SV has changed.
- 3 Inhibit action is not performed (action OFF at scale over input error).

Note

- ◆ When IH is set to OFF, 1 or 2, EVENT/DO action turns ON when a scale over error occurs on the EVENT/DO set side.
- ◆ When IH is set to 3, EVENT/DO action turns OFF when a scale over error occurs on the EVENT/DO set side.
- ◆ To output an alarm when a scale over error occurs with IH set to 3, assign scale over (SO) to other EVENT/DO.

12-3 Event Logic Operations

Logic operations can be assigned to EV1 to EV3, and DO1 to DO3.

This function performs logic operations on inputs from two DIs or Time signals, and outputs the result to EVENT/DO. DI signal can also be output by communication. Simple sequences can be performed by using timer/count functions.

■ **Event logic operation block diagram**

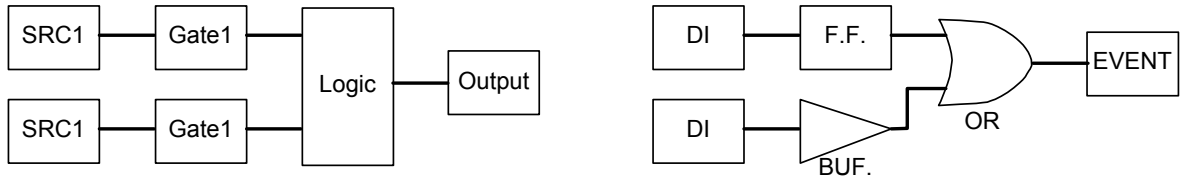

The screens below are for when [LOGIC] has been assigned to EV1.

(1) **Logic operation mode (Log MD)**

```

4-3
EV1 Log MD AND
MD: LOGIC ACT: N.O.
SRC1: None Gate1: BUF
SRC2: None Gate2: BUF
    
```

Setting range AND, OR, XOR
Initial value AND

AND	Logical product of 2 inputs	EVENT/DO turn ON when both of the two inputs turn ON.
OR	Logical sum of 2 inputs	EVENT/DO turn ON when either of the two inputs turns ON.
XOR	Exclusive OR of 2 inputs	EVENT/DO turn ON when one of the two inputs turns ON and the other turns OFF.

(2) Assigning logic operation input (SRC1, SRC2)

Assign the DI No. or time signal No. to two inputs (SRC1 & SRC2) for logic operation.

```

4-3
EVT Log MD: AND
MD: LOGIC   ACT: N. O.
SRC1: None  Gate1: BUF
SRC2: None  Gate2: BUF

```

Setting range

None, TS1 to TS8, DI1 to DI10

Initial value

None (no assignment)

Note

- ◆ When another function is assigned to DI, the function also starts to operate when that DI signal is input.
- ◆ When the assignment to DI is set to None, the function does not operate.

(3) Logic operation input logic (Gate1, Gate2)

Set the logic of the two inputs for logic operation.

```

4-3
EVT Log MD: AND
MD: LOGIC   ACT: N. O.
SRC1: None  Gate1: BUF
SRC2: None  Gate2: BUF

```

Setting range

BUF, INV, FF

Initial value

BUF

BUF (buffer)

The input signal is treated as it is.

INV (inverter)

The input signal is inverted, then treated as the logic signal.

FF (flip-flop)

The logic signal toggles each time the input signal turns from OFF to ON.

Note

- ◆ When the logic operation input is a time signal (TS1 to TS8), FF (flip-flop) cannot be set.

12-4 Timers/Counters

Timers and counters can be assigned to DO4 and DO5.

With this function, DI or TS is taken as input and EVENT/DO is taken as output, and EVENT/DO can be output after the preset time has elapsed after generation of an input, or when the input of the preset count is reached.

The timers and counters operate regardless of the control action of this device, and output a one-shot pulse of one second.

The screens below are for when [LOGIC] has been assigned to DO4 and DO5.

(1) Timer time

The time can be set within the range 1 to 5000 seconds only when the mode (Log MD) is set to timer.

```

4-9
DO4 Time: OFF
MD: LOGIC ACT: N. O.
SRC: None
Log MD: Timer
  
```

Setting range OFF, 1 to 5000 s
Initial value OFF

(2) Counter

The count can be set within the range 1 to 5000 only when the mode (Log MD) is set to counter.

The pulse width of DI must be 100ms or more.

```

4-9
DO4 Count: OFF
MD: LOGIC ACT: N. O.
SRC: None
Log MD: Counter
  
```

Setting range OFF, 1 to 5000
Initial value OFF

(3) Assigning input (SRC)

Assign the DI No. or TS No.

```

4-9
DO4 Time: OFF
MD: LOGIC ACT: N. O.
SRC: None
Log MD: Timer
  
```

Setting range None, TS1 to TS8, DI1 to DI10
Initial value None (no assignment)

Note

- ◆ When another function is assigned to DI, the function also starts to operate when that DI signal is input.
- ◆ When the assignment to DI is set to None, the function does not operate even if the DI signal is input.

(4) Mode (Log MD)

Select and set timer or counter.

```

4-9
DO4 Time: OFF
MD: LOGIC ACT: N.O.
SRC: None
Log MD▶Timer

```

Setting range

Timer, Counter

Initial value

Timer

Timer DO turns ON after DI is input and a preset time elapses.

Counter DO turns ON when DI input count reaches the preset value.

13 OPTION (HB, COM, DI, AO) SETTINGS

13-1 Setting the Heater Break/Heater Loop Alarms

This function is optional and is not displayed when it is not available.

This function outputs an alarm when the heater has burned out during control (heater break) or when some trouble on the final control element causes a heater current to flow when output is OFF (heater loop error).

Alarm output is assigned to EVENT/DO (external output), and HBA (heater break alarm) or HLA (heater loop alarm) is assigned for use.

Heater Break Alarm and Heater Loop Alarm can be used when Control Output 1 or Control Output 2 is a contact (Y) or SSR drive voltage (P).

These alarms cannot be used if control output is current (I) or voltage (V).

Hysteresis is fixed to 0.2A.

(1) Connecting the Current Transformer (CT)

Pass the load wire through the hole of the CT (provided with this device).

Wire from the CT terminal to the CT input terminal on this device.

The wire has no polarity.

For 30A CT CTL-6-S

For 50A CT CTL-12-S36-8

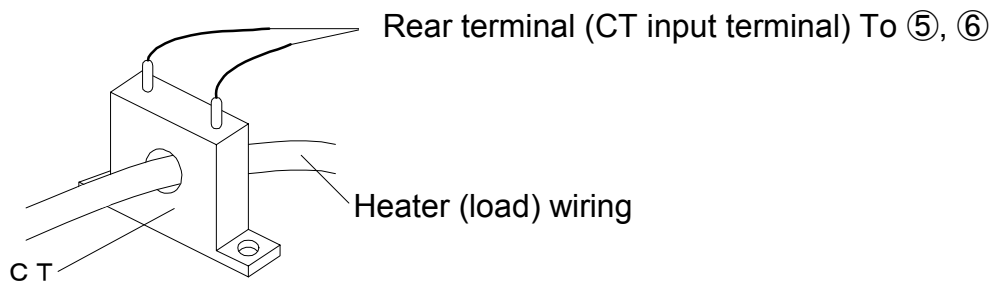

(2) Heater current monitor

The monitor displays the current value detected by the current transformer (CT).

```

5-7
Heater [ 0.0A ]
HBA: OFF
HLA: OFF
HBM: Lock HB: OUT1

```

Display range 0.0 to 50.0 A

- ◆ "HB_HH" is displayed on the LCD display screen when the detection current exceeds 55.0A.
- ◆ "----" is displayed on the LCD display screen when the current cannot be detected.

(3) Heater Break Alarm current (HBA)

An alarm is output when the current of the load wire is smaller than the preset value.

```

5-7
Heater [ 0.0A ]
HBA: OFF
HLA: OFF
HBM: Lock HB: 0UI1

```

Setting range OFF, 0.1 to 50.0 A
Initial value OFF

Note

- ♦ To use Heater Break Alarm, HBA must be assigned for EVENT/DO in EVENT/DO group.

(4) Heater Loop Alarm current (HLA)

An alarm is output when the current of the load wire is greater than the preset value.

```

5-7
Heater [ 0.0A ]
HBA: OFF
HLA: OFF
HBM: Lock HB: 0UI1

```

Setting range OFF, 0.1 to 50.0 A
Initial value OFF

Note

- ♦ To use Heater Loop Alarm, HLA must be assigned for EVENT/DO in EVENT/DO group.

(5) Heater Break/Heater Loop Alarm mode (HBM)

You can select the real mode or the lock mode as the alarm output mode.

```

5-7
Heater [ 0.0A ]
HBA: OFF
HLA: OFF
HBM: Lock HB: 0UI1

```

Setting range Real, Lock
Initial value Real

Real Once the alarm is output, alarm output is canceled when the heater current returns to normal.

Lock Once the alarm is output, alarm output is locked (fixed), and is output continuously even if the heater current returns to normal.
Alarm output can be canceled by setting HBA/HLA to OFF or turning the power OFF.

(6) Heater Break detection Selection (HB)

Select the control output at which Heater Break is detected.

This parameter can be set when 2-output specification is selected, and specified either Y/Y, P/P, Y/P or P/Y for output 1/output 2.

```

5-7
Heater [ 0.0A ]
HBA: OFF
HLA: OFF
HBM: Lock HB OUT1

```

Setting range

OUT1, OUT2

Initial value

OUT1

13-2 Communication

(1) Setting communication

For details, refer to the separate manual "FP23 Series Programmable Controller, Communications Interface (RS-232C/RS-485)."

This section explains only setting items.

5-8

COM PROT	SHIMADEN
ADDR:	1
BPS :	9600
MEM :	EEP

PROT: Communication protocol

Setting range SHIMADEN, MOD_ASC,
MOD_RTU

Initial value SHIMADEN

ADDR: Communication address

Setting range 1 to 98

Initial value 1

BPS: Communication speed

Setting range 2400, 4800, 9600, 19200 bps

Initial value 9600 bps

MEM: Communication memory mode

Setting range EEP, RAM, R_E

Initial value EEP

5-9

COM DATA	7
PARI :	EVEN
STOP:	1
DELY:	10 ms

DATA: Communication data length

Setting range 7, 8

Initial value 7

PARI: Communication parity

Setting range EVEN, ODD, NONE

Initial value EVEN

STOP: Communication stop bit

Setting range 1, 2

Initial value 1

DELY: Communication delay time

Setting range 1 to 50 ms

Initial value 10 ms

5-10

COM CTRL	STX_ETX_CR
BCC:	ADD

CTRL: Control code

Setting range STX_ETX_CR,
STX_ETX_CRLF, @_: _CR

Initial value STX_ETX_CR

BCC: Block Check Character

Setting range ADD, ADD_two's cmp,
XOR, None

Initial value ADD

(2) Communication Mode (COM)

Select whether or not to set or change various data using the front panel keys (local) or by communication (option).

1-1

AT :	OFF
MAN:	OFF
COM <input type="checkbox"/>	LOCAL

AT :	OFF
MAN:	OFF
COM <input checked="" type="checkbox"/>	LOCAL

Setting range	LOCAL, COM
Initial value	LOCAL

In the LOCAL mode, the key sign is displayed at the communication selection, indicating that changing from LOCAL (local) to COM (communication) by the front panel keys isn't possible.

Even in the LOCAL mode, the Communication mode can be changed from LOCAL to COM by sending commands to the FP23 from the host.

In the COM mode, the Communication mode can also be changed from COM to LOCAL by operating the front panel keys.

LOCAL Settings can be made using the front panel keys.
(Settings cannot be made by communication.)

COM Settings can be made by communication.
(Settings cannot be made by the front panel keys.)

13-3 DI

DI is digital input for external control based upon an externally input non-voltage contact signal or an open collector signal.

Actions can be selected, and assigned to DI2 to DI10.

Note, however, that DI1 is fixed to RUN/RST.

(1) DI monitor screen

is highlighted as when a signal is input to DI regardless of whether or not DI is assigned.

DI5 to DI10 are optional, and are not displayed when they are not available.

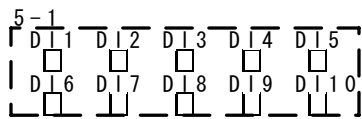

(2) Selecting DI Action

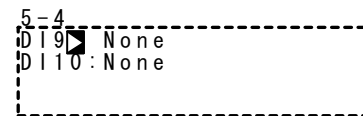
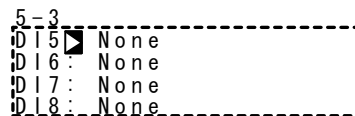

This is the assignment to DI.

LG is displayed for the DI to be used by input (SRC) in event logic operations. For details, See “12-3 (2) Assigning logic operation input (SRC1, SRC2)”.



Restriction conditions when assigning DI

- ◆ RUN/RST is assigned (fixed) to DI1. This assignment cannot be changed.
- ◆ PTN2bit and PTN3bit can be assigned only to DI5 and DI8.
- ◆ PTN4bit and PTN5bit can be assigned only to DI5.

■ List of DI Types

Mode	Action	No-action Conditions	Signal Detection
None	No action (factory default)	----	----
RUN/RST	Switching of Run/Reset (when ON: Run execution)	None	Edge
RST	Forced Reset (when ON: Reset state)	None	Level
HLD	Control suspension/restart (when ON: suspension state)	None	Level
ADV	Execute advance (when ON: execute advance)	HLD	Edge
FIX	Switching of FIX mode/Program mode (when ON: FIX mode)	None	Level
MAN	Switching of control output between auto/manual (when ON: manual)	AT	Level
LOGIC	Logic operation input [exclusive port] (when ON: input ON)	None	Level
PTN2bit	Selection of start pattern No. by DI input (selectable from 3 patterns)	FIX	Level
PTN3bit	Selection of start pattern No. by DI input (selectable from 7 patterns)	FIX	Level
PTN4bit	Selection of start pattern No. by DI input (selectable from 15 patterns)	FIX	Level
PTN5bit	Selection of start pattern No. by DI input (selectable from 20 patterns)	FIX	Level

Note 1 The corresponding DI action details cannot be executed while parameters listed in the "No-action Conditions" column in the DI Assignments Table are being executed.

Note 2 Signal detection timing:

Level input Action is maintained with DI input ON.

Edge input Action is executed by DI input ON, and is maintained even if DI input turns OFF. Action is canceled by DI input ON again.

Note 3 DI input must be held at ON or OFF for at least 0.1 sec. to detect DI input.

Note 4 Once a function is assigned to a DI, the same function cannot be set by the front panel keys as DI is given priority.

Note 5 When the same action is assigned to two or more DIs, the DI having the smallest No. is valid under the following conditions, and DIs having a larger No. are invalid:

- (1) When the same action is assigned to multiple DIs.
For example, assignment DI2 becomes invalid when MAN is assigned to DI1 and DI2.
- (2) When action types (PTN2bit, PTN3bit, PTN4bit, PTN5bit) that use multiple DI terminals are assigned to multiple DIs.
For example, assignment to DI8 becomes invalid when PTN3bit is assigned to DI5 and DI8.

Note 6 When action types (PTN2bit, PTN3bit, PTN4bit, and PTN5bit) that use multiple DI terminals are assigned, the assigned action of the DI to be used will be cleared depending on the assignment.

When DI5 is assigned to PTN5bit with MAN assigned to DI6, MAN assigned to DI6 is canceled as the start pattern No. will be assigned to DI6.

Note 7 When a DI assignment is canceled during DI execution, the currently executing action is continued (excluding LOGIC operation).

Note 8 For details on logic operation, see "12-3 Event Logic Operations."

■ Selection of start pattern No.

The start pattern No. can be selected by the external input.

To use this function, PTN2bit, PTN3bit, PTN4bit, or PTN5bit must be assigned to DI5, or PTN2bit or PTN3bit must be assigned to DI8, and the EXT lamp must be set to light.

Ex: To assign [PTN5bit] to DI5, and select start pattern No.5

The start pattern No. is automatically assigned from DI5 to DI9, and the \square key mark is displayed. To select start pattern No.5, short across DI COM (terminal No.44) and DI5 (terminal No.38), and DI7 (terminal No.40) according to the following table.

DI (terminal No.)	Start Pattern No.																				
	0	1	2	3	4	5	6	7	8	9	10	11	12	13	14	15	16	17	18	19	20
DI5 (38)		*		*		*		*		*		*		*		*		*		*	
DI6 (39)			*	*			*	*			*	*			*	*			*	*	
DI7 (40)					*	*	*	*					*	*	*	*					*
DI8 (41)									*	*	*	*	*	*	*	*					
DI9 (42)																	*	*	*	*	*

* mark indicates short across DI COM (44).

Note

- ◆ When start pattern No.0 is selected (DI input in OPEN state), the start pattern No. becomes No.1.

13-4 Analog Output

This function is optional and is not displayed when it is not installed.

All of the following assignments are possible for both Analog Output 1 (Ao1) and Analog Output 2 (Ao2).

(1) Analog Output type

```

5-5
Ao1MD: PV
Ao1_L: 0.0°C
Ao1_H: 1370.0°C
  
```

Setting range

PV, SV, DEV, OUT1, OUT2

Initial value

Ao1: PV

Ao2: SV

PV : Measured value

SV : Target set value

DEV : Deviation of PV and SV

OUT1 : Control Output 1

OUT2 : Control Output 2

(2) Scaling Analog Output

```

5-5
Ao1MD: PV
Ao1_L: 0.0°C
Ao1_H: 1370.0°C
  
```

■ Setting ranges and defaults

(Ao1_L < Ao1_H, or Ao2_L < Ao2_H)

Description	Analog output Type	Setting Range	Default
Ao1_L analog output 1 lower limit scaling Ao2_L analog output 2 lower limit scaling	PV, SV	Within measuring range	Setting range lower limit value
	DEV	-100.0 to 100.0%	
Ao1_H analog output 1 higher limit scaling Ao2_H analog output 2 higher limit scaling	OUT1, OUT2	0.0 to 100.0%	0.0%
	PV, SV	Within measuring range	Setting range higher limit value
	DEV	-100.0 to 100.0%	
	OUT1, OUT2	0.0 to 100.0%	100.0%

14 KEY LOCK SETTING

14-1 Setting Key Lock

(1) Displaying the key lock screen

To call up the LOCK, etc. screen group (group 8) from the basic screen, press the **GRP** key.

Press the **SCRN** key in the LOCK, etc. screen group to switch to the screens for making and changing setups.

Select parameters in screens by pressing the **↻** key.

Set parameters by pressing the **◀** **▼** or **▲** key, and press the **ENT** key to fix and register settings.

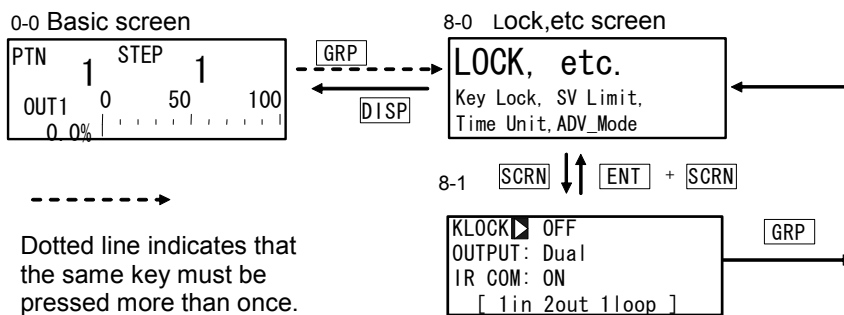

(2) Key lock

When Key lock is applied, **🔒** (key mark) is displayed at the relevant parameter on the LCD screen and the parameter cannot be set or changed.

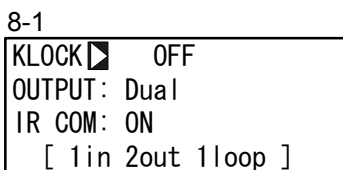

Setting range	OFF, LOCK1, LOCK2, LOCK3
Initial value	OFF

LOCK1 Locks parameters other than SV-related, AT, MAN, and EVENT/DO parameters.

LOCK2 Locks parameters other than SV-related parameters.

LOCK3 Locks all parameters. (excluding the key lock parameter itself)

For details on parameters that are locked, see "18 List of Parameters."

15 MONITORING, EXECUTING & STOPPING OPERATION

To execute Program control or Fixed value control, the basic screen (No.0-0) must be displayed.

When another screen is displayed, press the **[DISP]** key to move to the basic screen.

15-1 Operations in Basic Screen

The following operations are possible in the basic screen in a reset state:

- (1) Setting the start pattern
- (2) Setting the start step
- (3) Setting FIX mode (between the Program mode and the FIX mode)
- (4) Changing FIX SV value (can be changed while execution)
- (5) Start/Stop Program control/Fixed value control

(1) Setting the start pattern

Set the start pattern before the program is started.

When the **[PTN]** key is pressed in Basic screen group top screen, the program pattern No. on the LCD display blinks and is incremented. (It can also be changed by the **[▲]** or **[▼]** key if it is blinking.)

When you press the **[ENT]** key after changing the program pattern No. to fix the setting, blinking stops.

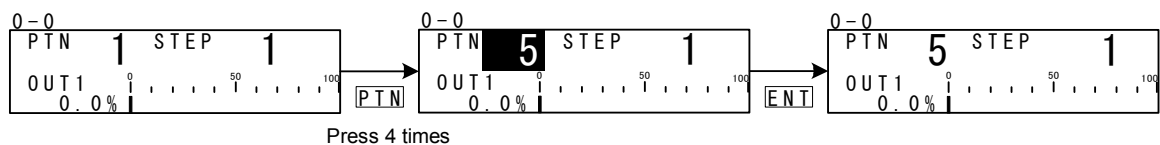

(2) Setting the start step

Set the start step before the program is started.

When the **[STEP]** key is pressed in Basic screen group top screen, the program step No. on the LCD display blinks and is incremented. (It can also be changed by the **[▲]** or **[▼]** key if it is blinking.)

When you press the **[ENT]** key after changing the program step No. to fix the setting, blinking stops.

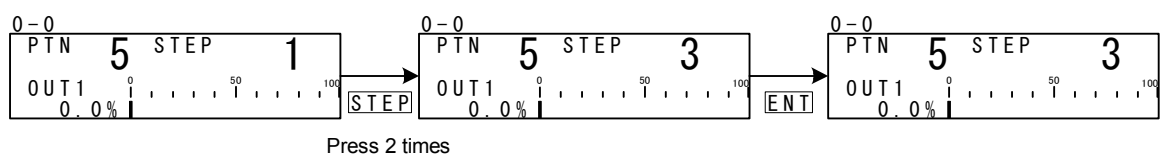

When "0" is set to the start step, that pattern is not executed. To execute control, set a value other than "0" to the start step.

(3) Setting the FIX mode

When the **PTN** key is pressed in Basic screen group top screen, the program pattern No. on the LCD display blinks and is incremented. (It can also be changed by the **▲** or **▼** key if it is blinking.)

When "F" is selected, and the **ENT** key is pressed to fix the setting, blinking stops.

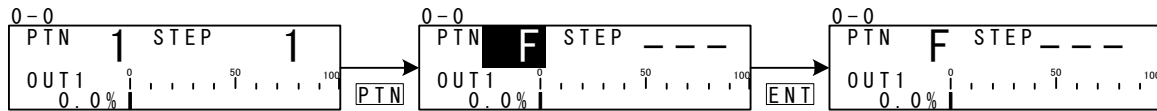

Note

- ◆ When the mode is changed from the Program mode to the FIX mode, the move operation changes depending on the FIX MOVE setting. For details, see "10-4 FIX MOVE."

(4) Setting the FIX SV value (only in FIX mode)

In the FIX mode, pressing the **◀**, **▲** or **▼** key in Basic screen group top screen causes the lowermost digit in the SV display to blink.

Press the **◀** key to move the blinking section on the numerical value to the digit to be changed, and press the **▲** or **▼** key to change the SV value. After changing the SV value, press the **ENT** key to fix the setting. The blinking section on the numerical value stops.

15-2 Displaying the Step No. and SV

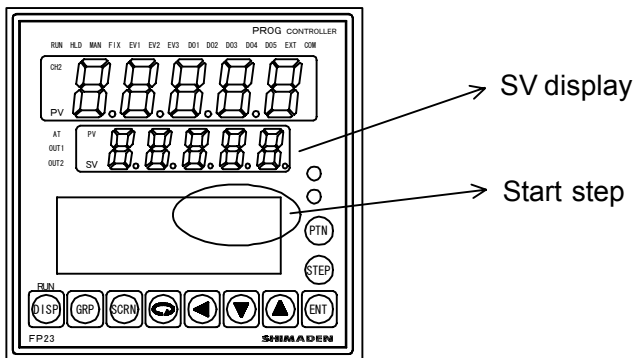

The following table shows the relationship between the start step No. in Reset state and the SV display.

Start Step No.	SV display	
	Program mode	FIX mode
0	Starting SV	
1	Starting SV	
2 to 400	Previous step's SV	
---		FIX SV

15-3 How to Start / Stop Control

Check the following again before starting control:

1. The LCD display shows the Basic.
2. Confirm if the FP23 is in the desired control mode (Program or FIX).
3. The LCD display shows the desired start pattern/start step.

In the Basic screen, press the **ENT** + **DISP** keys, to start (RUN lamp lit) / stop control.

16 OPERATIONS DURING CONTROL

16-1 Monitoring Control

(1) Basic screen



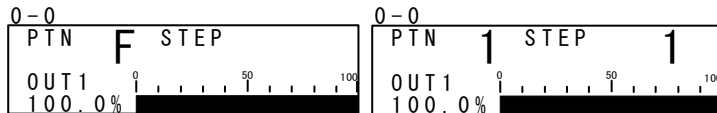

During program control, the currently executing pattern and step are displayed. During fixed value control, "F" is displayed on the pattern display, and "- - -" is displayed on the step display indicating that the display is off.



(2) Output value display

The output values of Control Output 1 (OUT1) and Control Output 2 (OUT2: option) are displayed on the upper and lower sections, respectively, as a % and a bar graph. In the 1-output specification, OUT2 is not displayed.



During manual output, OUT1 or OUT2 can be selected by the  key, and output can be adjusted by operating the ,  or  key. For details, refer to "16-3 Switching Auto/Manual of Control Output".

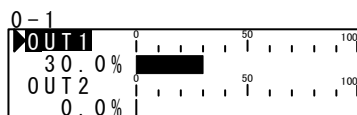

(3) Monitoring program status

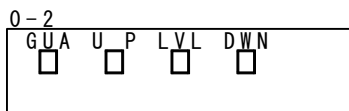

- GUA Lights in guarantee soak.
- UP Lights at execution of ascending step.
- LVL Lights at execution of flat step.
- DWN Lights at execution of descending step.

(4) Monitoring the remaining step time

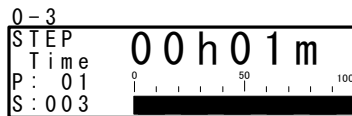

This screen is displayed only during program control.

The remaining time of the currently executing step is displayed. The display returns to the basic screen when a stop (RST) is input by DI or when the mode has moved to the FIX mode by DI.



(5) Monitoring the program

This screen graphically displays the program pattern.

With programs exceeding ten steps, you can scroll the monitor display in 1-step increments by pressing the  key to display the next ten steps, or pressing the  key to display the previous ten steps.

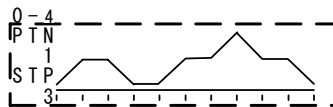

(6) Monitoring the pattern link

This screen is displayed only during program control.

The pattern link settings and execution state are displayed.

The currently executing pattern No. is displayed blinking.

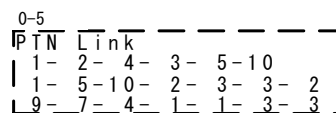

(7) Monitoring information during control execution

This screen is displayed only during control execution.

The states of the following four parameters are displayed.

Note, however, that only the PID No. is displayed during fixed value control (FIX).

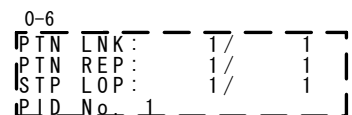

- PTN LNK Indicates the pattern link execution count and setting count.
- PTN REP Indicates the pattern execution count and setting count.
- STP LOP Indicates the execution count and setting count of the step loop.
- PID No. Indicates the PID No. currently in use.

16-2 Executing and Stopping Auto Tuning

Auto tuning (AT) can be executed and stopped.

During execution of auto tuning, the AT LED indicator blinks, lights during auto tuning standby, and goes out when auto tuning ends or stops.

1-1	
AT	OFF
MAN:	OFF
COM	LOCAL

Setting range ON, OFF

Initial value OFF

What is "auto tuning?"

Auto tuning automatically calculates the optimum PID constants by the limit cycle method so that control is executed using these values.

Note

- ◆ As auto tuning is affected by the output limiter during execution, set the lower and higher limit values of the control output value before executing auto tuning. (Normally, set the lower limit value to 0% and the higher limit value to 100%.)

◆ Auto tuning cannot be executed

	Program Mode	FIX Mode
Reset state (RST)	Auto tuning cannot be executed	Auto tuning cannot be executed
Manual output (MAN)	Auto tuning cannot be executed	Auto tuning cannot be executed
Zone PID set to "PV"	Auto tuning cannot be executed	Auto tuning cannot be executed
PV value scale over	Auto tuning cannot be executed	Auto tuning cannot be executed
PID P=OFF (ON-OFF control)	Auto tuning standby	Auto tuning cannot be executed

◆ Auto tuning end conditions

	Program Mode	FIX Mode
When the RUN state changes to the reset (RST) state	End of auto tuning	End of auto tuning
When output has elapsed for about 200 minutes in a 0% or 100% state	End of auto tuning	End of auto tuning
At power interruption	End of auto tuning	End of auto tuning
When PID operation has ended	---	End of auto tuning
When computation of all PID Nos. (No.1 to No.10) has ended	End of auto tuning	---
When PV value has exceeded the scale	End of auto tuning	End of auto tuning

◆About auto tuning during program control

Once AT has been executed, the program judges whether the current step is a ramp section or a flat section, and stands by for the next step in an AT standby state (lamp lit) on ramp sections. At flat sections, AT is executed (lamp blinks) using the PID No. of that step.

Note, however, that under the conditions, the above operation sometimes is not performed.

- (1) If the FP23 is in Hold state, AT is executed even if the current step is a ramp section.
- (2) AT forcibly ends at PV scale over.
- (3) The state changes to the AT standby state when P=OFF (ON-OFF control).
- (4) For PID Nos. obtained by AT execution once and set with appropriate PID values, the state is the AT standby state even on flat sections until the program ends, and AT is not executed as long as AT is not performed again.

The following shows an example of AT execution at Step3.

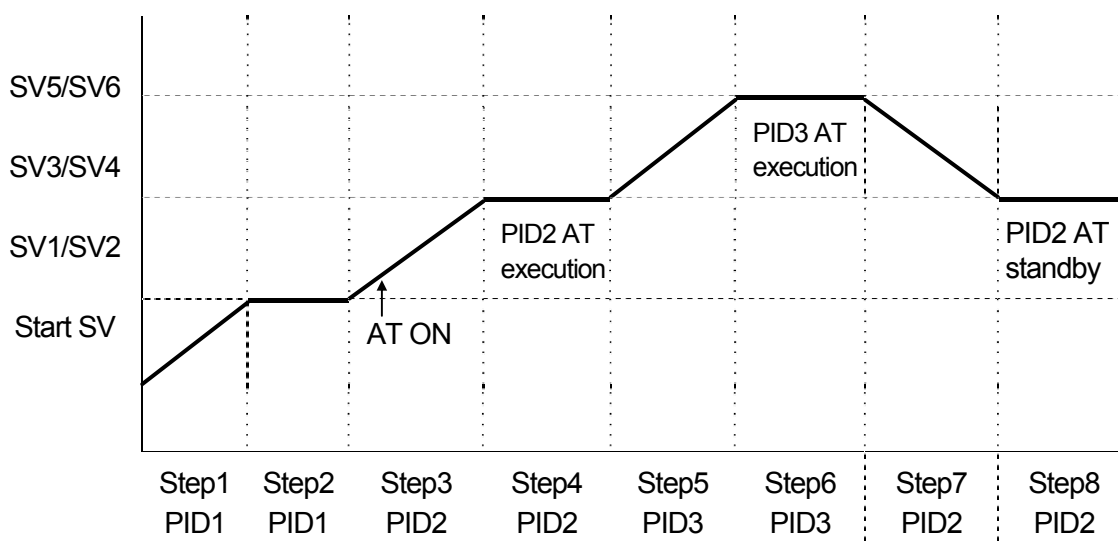

Step3 AT is in a standby state as the step is a ramp section. (AT LED lit)

Step4 AT of flat section PID2 is executed (AT LED blinks), and becomes a standby state at the remaining time (AT LED lit).

Step5 AT is in a standby state as the step is a ramp section. (AT LED lit)

Step6 AT of flat section PID3 is executed (AT LED blinks), and becomes a standby state at the remaining time (AT LED lit).

Step7 AT is in a standby state as the step is a ramp section. (AT LED lit)

Step8 AT is in a standby state (AT LED lit) as computation of PID2 has ended at Step4.

*1 AT also ends (AT LED Out) at program end (Step8).

*2 In the case of this example, AT of PID1 is not performed.

Note

- ◆ When there is not enough step execution time at flat sections, and AT does not end, AT execution of that No. is carried out to the next time.

◆About auto tuning during fixed value control (FIX)

During FIX control, the AT lamp blinks from the moment that AT is started.
When AT ends, the AT lamp automatically goes out.

16-3 Switching Auto/Manual of Control Output

Normally, automatic operation is performed. However, use this item to manually set control output, for example, during device testing.

During manual output, note that the set value is continually output and feedback control is not performed.

During manual output, the MAN monitor lamp and status monitor are displayed blinking.

1-1		Setting range	OFF, ON
AT	OFF	Initial value	OFF
MAN	OFF		
COM	LOCAL		

The manual execution conditions (common to front panel keys and external switch input) are as follows:

- (1) AT must not be in progress.
- (2) The FP23 must not be in a Reset (RST) state.

(1) Manual output operations

In a 1-output specification, the output value of OUT2 and the output bar graph are not displayed on the screen.

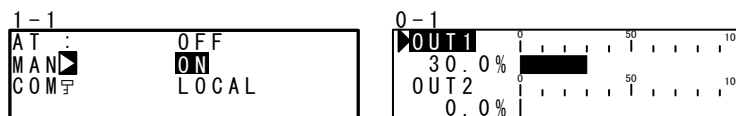

1. In the setup screen (1-1), select MAN (manual) using the cursor, and select ON to register manual output.
2. Next, to perform control output manually, move to the basic screen (group 0) by the **[DISP]** key, and move to the output value display (0-1) screen by the **[SCRN]** key. At this time, make sure that the cursor (**[▶]**) is displayed at the top left of the LCD screen.
3. You can select OUT1 or OUT2 by the **[↺]** key, and adjust the output by the **[◀]**, **[▲]** or **[▼]** key.
There is no need to register and fix settings by the **[ENT]** key.

(2) Simple key-based manual output operations

In the output value display screen (0-1), you can switch automatic/manual by pressing the **ENT** + **▲** keys, or the **ENT** + **▼** keys.

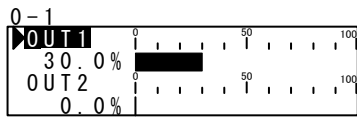

ENT + **▲** or **ENT** + **▼**

16-4 Temporarily Holding (HLD) and Resuming Program Execution

Hold is a function for temporarily holding program control. When this function is set to ON, HLD is executed, and when it is set to OFF, HLD is canceled.

During HLD execution, the HLD monitor lamp and status monitor are lit.

1-2			
HLD	OFF	Setting range	OFF, ON
ADV:	OFF	Initial value	OFF
Start PTN:	1		

In the following example, the remaining Step5's period is used to reach SV5 after HLD is canceled.

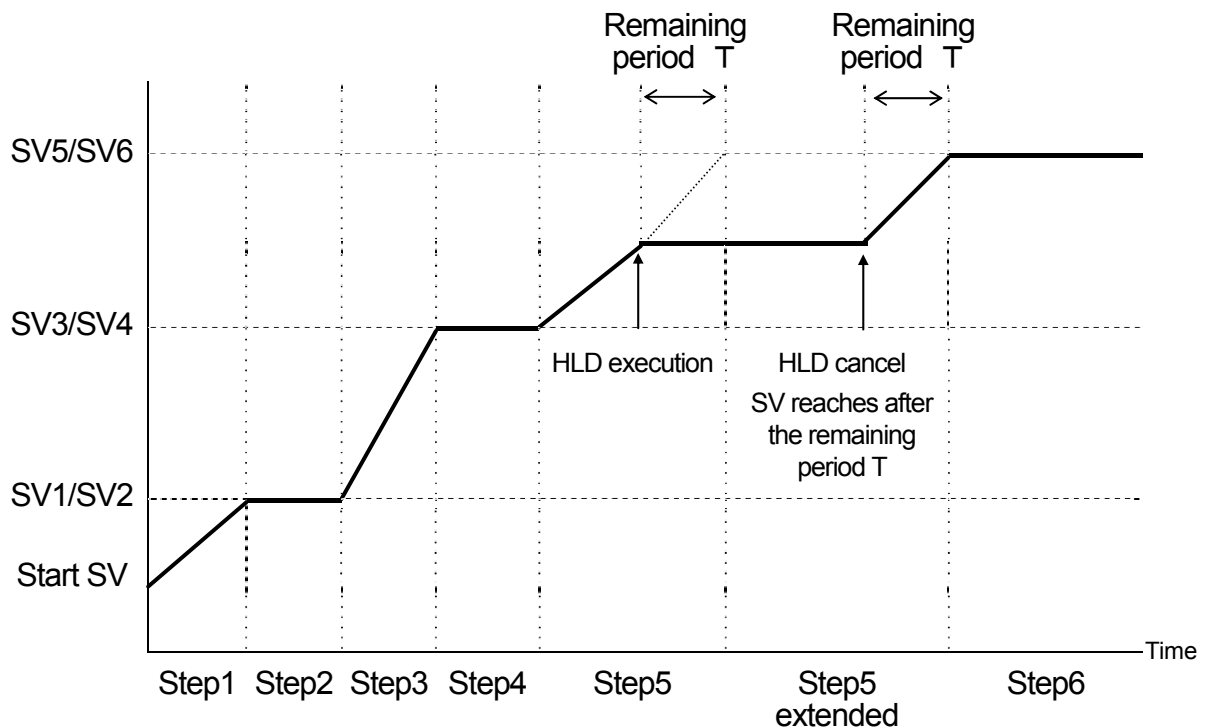

- *1 HLD is enabled even in the guarantee soak.
- *2 ADV cannot be executed during HLD.
- *3 HLD operation by key entry or communication is enabled only when DI is not assigned. (DI input is given priority.)
- *4 When a program is executed with HLD DI input ON, program execution is dependent on the SV value of the PV start function.
 Ex: When PV start is ON, hold by SV value of PV start
 When PV start is OFF, hold by start SV
- *5 During HLD, changes to parameters are not reflected until HLD is canceled even if start V, step SV and time signal related parameters are changed.

16-5 Executing Advance (ADV)

Advance is a function for forcibly moving to the next step (or time) from the current step (or time) during program execution.

1. Step move: Program advance in step units (single steps).
2. Time move: Program advance in time units.

For details on the setting of move action by ADV execution and ADV time when time move is set, see "9-1 (5), Advance mode," and "9-1 (6), Advance time."

1-2	
HLD:	OFF
ADV	OFF
Start PTN:	1

Setting range ON, OFF
Initial value OFF

Note

- ◆ ADV is disabled for about two second after ADV is executed.
- ◆ In a guarantee soak (GUA) state, GUA is canceled on both the step and time, and the program only moves to the next step.
- ◆ Advance cannot be executed during a hold (HLD).

Example) Move by step (forcibly end step 5 and move to step 6)

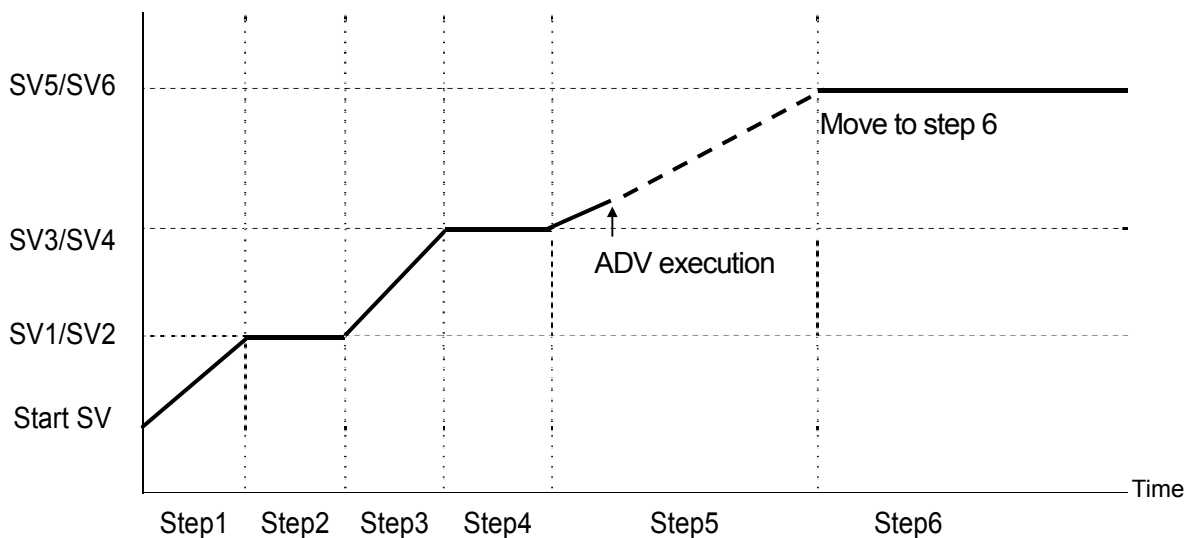

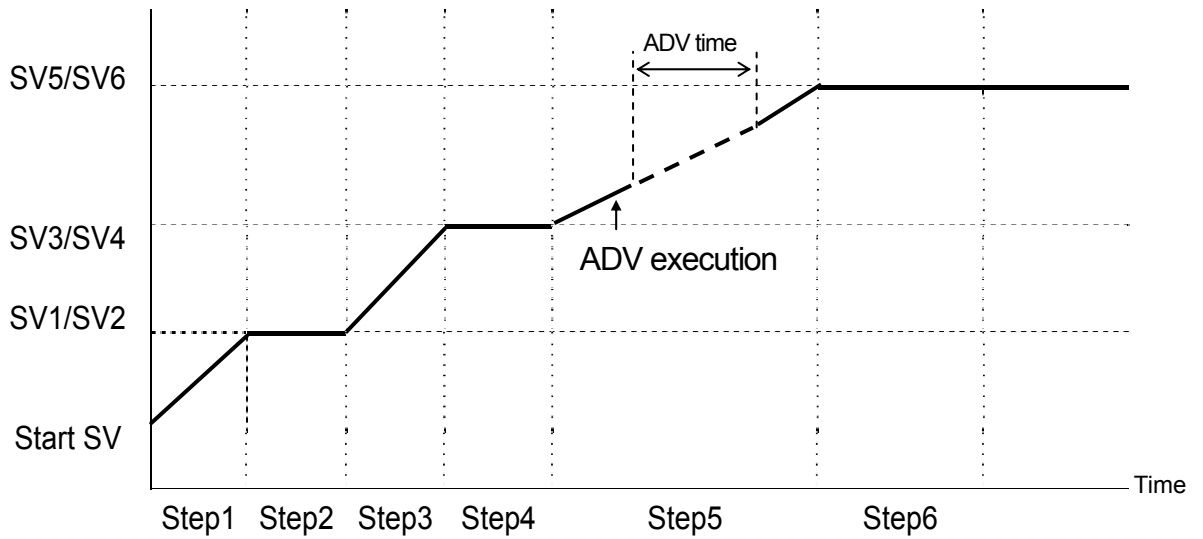
Example) Move by time (move by ADV time only)*Note*

- ◆ In time selection, when the ADV time is greater than the remaining time of that step, advance beyond the next step is not performed, and the program only advances to the next step in the same way as in step selection.

17 ERROR DISPLAYS

17-1 Operation Check Abnormalities at Power ON

This device displays the following error codes on the PV display when an error is detected.

Display	Cause	
<i>E - r o ñ</i>	ROM error	In any of the states shown on the left, all outputs turn OFF or become 0%.
<i>E - r A ñ</i>	RAM error	
<i>E - E E P</i>	EEPROM error	
<i>E - A d 1</i>	Input 1 A/D error	
<i>E - S P c</i>	Hardware error	

Request

- ◆ If any of the messages shown in the table are displayed, repair or replacement is required. Immediately turn the power OFF, and contact your dealer.

17-2 PV Input Abnormalities

When a PV input-related abnormality is detected during execution of control on this device, the following error codes are displayed on the PV display.

Display	Cause
<i>Sc.LL</i>	The PV value exceeded the measuring range lower limit (-10%FS).
<i>Sc.HH</i>	The PV value exceeded the measuring range higher limit (+110%FS).
	RTD Burnout
	Thermocouple Burnout
<i>b----</i>	One or two RTD-B burnout, or all leads of the RTDs burnout. Action of this device in this case is PV moving excessively towards the higher limit.
<i>U.LL</i>	Reference junction compensation (-20°C) is at the lower limit. (thermocouple input)
<i>U.HH</i>	Reference junction compensation (+80°C) is at the higher limit. (thermocouple input)

Request

- ◆ Check input or the heater lead when the above messages are displayed. If the input or the heater lead is not in error and there is another probable cause, contact your dealer.

17-3 Heater Current Abnormalities (option)

When a heater current abnormality is detected during execution of control on this device the following error codes are displayed on the LCD.

Display	Cause
HB_HH	The heater current exceeds 55.0A.

18 LIST OF PARAMETERS

This chapter lists all of the parameters used by the FP23. Parameters that cannot be set by the user are not listed.

Display Symbol	Indicates the parameter symbol displayed on the LCD screen.
Description of Function	Indicates the display or setup details.
Setting range	Indicates the range of parameters or numerical values that can be set.
Initial Value	Indicates the factory default. (Excluding instances where this device is shipped with values customized to customer specified values)
Lock	Number indicates the level at which key lock is valid.
*	Indicates a parameter that may be initialized when one of a range setting, unit setting or PV scaling setting has been changed. Parameters marked by * may need to be confirmed again when the above settings have been changed.

18-1 Execution Screen Group (group 1)

Display Symbol	Description of Function	Setting Range	Initial Value	Lock
AT	Auto Tuning	ON/OFF	OFF	2
MAN *	Manual output	ON/OFF	OFF	2
COM	Communication mode	LOC: Local settings COM: Communications settings	LOC	2
HLD	Hold	ON/OFF	OFF	1
ADV	Advance	ON/OFF	OFF	1
Start PTN	Start pattern No.	1 to 20	1	1
PTN Link Reps	Pattern link execution count	0 to 9999	0	1
Link Format 1st to 20th	Pattern link settings	0 to assigned pattern higher limit	0	1
FIX MODE	FIX mode selection	ON/OFF	OFF	1
FIX SV *	FIX SV value setting	Within SV limit setting range	0 Unit	3
FIX PID	FIX PID No. selection	1 to 10	1	1
FIX MOVE	FIX move selection	EXE EXE/STBY EXE/TRCK	EXE	1

Display Symbol	Description of Function	Setting Range	Initial Value	Lock
FIX EV Set Point EV1 to EV3 *	FIX EV action point setting	DEV_Hi: -25000 to 25000 Unit DEV_Low: -25000 to 25000 Unit DEV_Out: 0 to 25000 Unit DEV_In: 0 to 25000 Unit PV_Hi: Within measuring range PV_Low: Within measuring range	25000 Unit -25000 Unit 25000 Unit 25000 Unit Measuring range higher limit value Measuring range higher limit value	2
FIX DO Set Point DO1 to DO13 *	FIX DO action point setting	DEV_Hi: -25000 to 25000 Unit DEV_Low: -25000 to 25000 Unit DEV_Out: 0 to 25000 Unit DEV_In: 0 to 25000 Unit PV_Hi: Within measuring range PV_Low: Within measuring range	25000 Unit -25000 Unit 25000 Unit 25000 Unit Measuring range higher limit value Measuring range higher limit value	2

18-2 Program Screen Group (group 2)

Display Symbol	Description of Function	Setting Range	Initial Value	Lock
Num.of STEP	Number of steps	0 to assigned step higher limit	20	1
Start STEP	Start step	0 to number of steps	1	1
Start SV *	Start SV	Within SV limiter setting range	0 Unit	3
PTN Reprs	Pattern execution count	1 to 9999 times	1	1
Loop Setup				
Start	Start step No.	1 to number of steps	1	1
End	End step No.	1 to number of steps	1	1
Reprs	Execution count	1 to 9999 times	1	1
GUARantee Soak				
Zone *	Guarantee soak zone	OFF, 1 to 9999 Unit	OFF	1
Time *	Guarantee soak time	00: 00 to 99: 59	00: 00	1
PV Start	PV start	ON/OFF	OFF	1
EV Set Point EV1 to EV3 *	EV action point setting	DEV_Hi: -25000 to 25000 Unit DEV_Low: -25000 to 25000 Unit DEV_Out: 0 to 25000 Unit DEV_In: 0 to 25000 Unit PV_Hi: Within measuring range PV_Low: Within measuring range	25000 Unit -25000 Unit 25000 Unit 25000 Unit Measuring range higher limit value Measuring range higher limit value	2

Display Symbol	Description of Function	Setting Range	Initial Value	Lock
DO Set Point DO1 to DO13 *	DO action point setting	DEV_Hi: -25000 to 25000 Unit DEV_Low: -25000 to 25000 Unit DEV_Out: 0 to 25000 Unit DEV_In: 0 to 25000 Unit PV_Hi: Within measuring range PV_Low: Within measuring range	25000 Unit -25000 Unit 25000 Unit 25000 Unit Measuring range higher limit value Measuring range higher limit value	2
TS1 to TS8				
ON STEP	Time signal ON step	OFF, 1 to number of steps	OFF	1
ON Time	Time signal ON time	00:00 to 99:59	00:00	1
OFF STEP	Time signal OFF step	OFF, 1 to number of steps	OFF	1
OFF Time	Time signal OFF time	00:00 to 99:59	00:00	1

18-3 Step Screen Group (group 2S)

Display Symbol	Description of Function	Setting Range	Initial Value	Lock
STEP001 to 400				
SV *	Step SV	Within SV limiter setting range	0 Unit	3
Time	Step time	00:00 to 99:59	00:01	1
PID	Step PID No.	0 to 10	0	1

18-4 PID Screen Group (group 3)

Display Symbol	Description of Function	Setting Range	Initial Value	Lock
PID (01 to 10) -OUT1				
P	No.1 proportional band (OUT1)	OFF, 0.1 to 999.9 %	3.0 %	1
I	No.1 integral time (OUT1)	OFF, 1 to 6000 s	120 s	1
D	No.1 differential time (OUT1)	OFF, 1 to 3600 s	30 s	1
DF *	No.1 hysteresis (OUT1)	1 to 9999 Unit	20 Unit	1
MR	No.1 manual reset (OUT1)	-50.0 to 50.0 %	0.0 % (1-out spec) -50.0 % (2-out spec)	1
SF	No.1 set value function (OUT1)	0.00 to 1.00	0.40	1
ZN *	No.1 PID zone (OUT1)	Within measuring range	0 Unit	1
PID (01 to 10) -OUT2				
P	No.1 proportional band (OUT2)	OFF, 0.1 to 999.9 %	3.0 %	1
I	No.1 integral time (OUT2)	OFF, 1 to 6000 s	120 s	1
D	No.1 differential time (OUT2)	OFF, 1 to 3600 s	30 s	1
DF *	No.1 hysteresis (OUT2)	1 to 9999 Unit	20 Unit	1
DB *	No.1 dead band (OUT2)	-19999 to 20000 Unit	0 Unit	1
SF	No.1 target value function (OUT2)	0.00 to 1.00	0.40	1
ZN *	No.1 PID zone (OUT2)	Within measuring range	0 Unit	1
PID _(01 to 10) OUT1L	No.1 output limiter lower limit value (OUT1)	0.0 to 100.0 %	0.0 %	1
OUT1H	No.1 output limiter higher limit value (OUT1)	0.0 to 100.0 %	100.0 %	1
OUT2L	No.1 output limiter lower limit value (OUT2)	0.0 to 100.0 %	0.0 %	1
OUT2H	No.1 output limiter higher limit value (OUT2)	0.0 to 100.0 %	100.0 %	1
Zone PID1	Zone PID mode	OFF: PV: PV zone switching SV: SV zone switching	OFF	1
HYS1 *	Zone hysteresis	0 to 10000 Unit	20 Unit	1
AT Point *	Auto tuning point	0 to 10000 Unit	0	1

18-5 EVENT/DO Screen Group (group 4)

Display Symbol	Description of Function	Setting Range	Initial Value	Lock
EV1 to EV3, DO1 to DO13				
MD	EV1 to 3 DO1 to 13 Operation mode	None : No action DEV Hi : Higher limit deviation DEV Low : Lower limit deviation DEV Out : Outside higher/lower limit deviation DEV In : Inside higher/lower limit deviation PV Hi : PV higher limit absolute value PV Low : PV lower limit absolute value SO : Scale over FIX : In FIX mode AT : Auto tuning execution in progress MAN : Manual output LOGIC : Logic operation (*1 *2) Direct : Direct output (*3) RUN : RUN HLD : Program hold GUA : Guarantee soak zone STEP : Step signal PRG.END : Program end signal TS1 : Time signal 1 TS2 : Time signal 2 TS3 : Time signal 3 TS4 : Time signal 4 TS5 : Time signal 5 TS6 : Time signal 6 TS7 : Time signal 7 TS8 : Time signal 8 HBA : Heater Break Alarm output (*4) HLA : Heater Loop Alarm output (*4)	EV1: DEV Hi EV2: DEV Low EV3: RUN DO1 to 13: None	1
ACT	EV1 to EV3 DO1 to DO13 output characteristics	N.O.: Normally open N.C.: Normally closed	N.O.	1
DF *	EV1 to EV3 DO1 to DO13 hysteresis	1 to 9999 Unit	20 Unit	1
IH	EV1 to EV3 DO1 to DO13 standby action	OFF, 1/2/3	OFF	1
DLY	EV1 to EV3 DO1 to DO13 delay time	OFF, 1 to 9999 s	OFF	1

Display Symbol	Description of Function	Setting Range	Initial Value	Lock
EV1 to EV3 / DO1 to DO3				
SRC1 SRC2	Source input1 Source input 2	None/TS1 to TS8/DI1 to DI10	None	1
Gate1 Gate2	Gate input1 Gate input 2	BUF/INV/FF	BUF	1
Log MD	Logic operation mode	AND/OR/XOR	AND	1
DO4, DO5 (when MD = LOGIC)				
SRC	Source input	None/TS1 to TS8/DI1 to DI10	None	1
Log MD	Logic operation mode	Timer / Counter	Timer	1
Time	Timer	OFF, 1 to 5000 s	OFF	1
Count	Counter	OFF, 1 to 5000	OFF	1

*1 Logic operation (AND, OR, XOR) can be assigned only to LOGIC EV1 to EV3, and DO1 to DO3.

*2 Logic operation (Timer, Count) can be assigned only to DO4 and DO5.

*3 Direct output can be assigned only to DO6 to DO13 with communication option.

*4 This function is optional and is not displayed when it is not installed.

18-6 DI/Option Screen Group (group 5)

Display Symbol	Description of Function	Setting Range	Initial Value	Lock
DI1	DI1 assignment	RUN/RST (fixed)	RST	1
DI2	DI2 assignment	None RUN/RST RST HLD ADV FIX MAN LOGIC	None	1
DI3 DI4 DI6 DI7 DI9 DI10	DI3 assignment DI4 assignment DI6 assignment DI7 assignment DI9 assignment DI10 assignment	None RUN/RST RST HLD ADV FIX MAN LOGIC	None	1
DI5	DI5 assignment	None RUN/RST RST HLD ADV FIX MAN LOGIC PTN2bit PTN3bit PTN4bit PTN5bit	None	1
DI8	DI8 assignment	None RUN/RST RST HLD ADV FIX MAN LOGIC PTN2bit PTN3bit	None	1

Display Symbol	Description of Function	Setting Range	Initial Value	Lock
Ao1MD	Analog output 1 type	PV : Measurement value SV : Setting value DEV : Deviation value OUT1 : Output 1 OUT2 : Output 2	PV	1
Ao1_L *	Analog output 1 lower limit side scaling	PV, SV : Within measuring range DEV : -100.0 to 100.0 % OUT1,OUT2 : 0.0 to 100.0 %	Setting range lower limit value	1
Ao1_H *	Analog output 1 higher limit side scaling	PV, SV : Within measuring range DEV : -100.0 to 100.0 % OUT1,OUT2 : 0.0 to 100.0 %	Setting range higher limit value	1
Ao2MD	Analog output 2 type	PV : Measurement value SV : Setting value DEV : Deviation value OUT1 : Output value OUT2 : Output value 2	SV	1
Ao2_L *	Analog output 2 lower limit side scaling	PV, SV : Within measuring range DEV : -100.0 to 100.0 % OUT1,OUT2 : 0.0 to 100.0 %	Setting range lower limit value	1
Ao2_H *	Analog output 2 higher limit side scaling	PV, SV : Within measuring range DEV : -100.0 to 100.0 % OUT1,OUT2 : 0.0 to 100.0 %	Setting range higher limit value	1
Heater	Heater current value monitor	0.0 to 50.0A	---	---
HBA	Heater Break alarm	OFF, 0.1 to 50.0 A	OFF	1
HLA	Heater loop alarm	OFF, 0.1 to 50.0 A	OFF	1
HBM	Heater Break mode	Lock: Lock Real: Real	Lock	1
HB	Heater current detection selection	OUT1: Control Output 1 OUT2: Control Output 2 *1	OUT1	1

*1 HB can be selected when 2-output is specified, and the output 1/output 2 is any combination from Y/Y, P/P, Y/P or P/Y.

Display Symbol	Description of Function	Setting Range	Initial Value	Lock
COM PROT	Communication protocol	SHIMADEN, MOD_ASC, MOD_RTU	SHIMADEN	1
ADDR	Communication address	1 to 98	1	1
BPS	Communication speed	2400 bps 4800 bps 9600 bps 19200 bps	9600 bps	1
MEM	Communication memory mode	EEP : Write to EEPROM, RAM RAM : Write to RAM only R_E : Write to EEPROM other than SV, COM mode, out	EEP	1
COM DATA	Communication data length	7: 7 bit 8: 8 bit	7	1
PARI	Communication data parity	EVEN/ODD/None	EVEN	1
STOP	Communication stop bit	1/2	1	1
DELY	Communication delay time	1 to 50 ms	10 ms	1
COM CTRL *1	Communication control code	STX_ETX_CR STX_ETX_CRLF @:_CR	STX_ETX_CR	1
BCC *1	Communication BCC check	ADD ADD_two's cmp XOR None	ADD	1

*1 SHIMADEN protocol only

- DI5 to DI10 and Ao1MD to BCC are optional and are not displayed when they are not installed.

18-7 Control Output Screen Group (group 6)

Display Symbol	Description of Function	Setting Range	Initial Value	Lock
OUT1 ACT	Output 1 control characteristics	Reverse: Reverse characteristics Direct: Direct characteristics	Reverse	1
RST	Output preset value at output 1 reset	0.0 to 100.0 %	0.0 %	1
ERR	Output preset value at output 1 error	0.0 to 100.0 %	0.0 %	1
CYC	Output 1 proportional cycle time	1 to 120 s	Contact (Y) : 30 s SSR (P) : 3 s	1
OUT2 ACT *1	Output 2 control characteristics	Reverse: Reverse characteristics Direct: Direct characteristics	Direct	1
RST *1	Output preset value at output 2 reset	0.0 to 100.0 %	0.0 %	1
ERR *1	Output preset value at output 2 error	0.0 to 100.0 %	0.0 %	1
CYC *1	Output 2 proportional cycle time	1 to 120 s	Contact (Y) : 30 s SSR (P) : 3 s	1
Rate Limiter				
Out1	Output 1 rate-of-change limiter	OFF, 0.1 to 100.0 %/s	OFF	1
Out2 *1	Output 2 rate-of-change limiter	OFF, 0.1 to 100.0 %/s	OFF	1

*1 Control output 2 is optional and is not displayed when it is not installed.

18-8 Unit/Range Screen Group (group 7)

Display Symbol	Description of Function	Setting Range	Initial Value	Lock
PV Bias *	PV bias	-10000 to 10000 Unit	0 Unit	1
PV Filter	PV filter	OFF, 1 to 100 Sec	OFF	1
PV Slope * *1	PV slope	0.500 to 1.500 Unit	1.000	1
RANGE	Measuring range	01 to 19: Thermocouple 31 to 58: RTD 71 to 77: Voltage (mV) 81 to 87: Voltage (V)	06	1
Sc_L *	PV lower limit side scaling	-19999 to 29990 Unit	0 Unit	1
Sc_H *	PV higher limit side scaling	-19989 to 30000 Unit	1000 Unit	1
UNIT *	Measurement unit	RTD, TC : °C, °F I, V :%, °C, °F, None	RTD, TC : °C I, V :%	1
DP *	Decimal point position	XXXXX. XXXX.X XXX.XX XX.XXX X.XXXX	XXXX.X	1
Figure * *2	Number of digits past decimal point	Normal : Digits past decimal point Short : No digits past decimal point	Normal	1
CJ *3	Cold junction compensation	Internal : Internal compensation External : External compensation	Internal	1
SQ.Root * *4	Square root extraction	OFF : No operation ON : Operation	OFF	1
Low cut *5	Low cut (Voltage input)	0.0 to 5.0 %	1.0 %	1
PMD *4	Linearizer approximation	OFF : Approximation OFF ON : Approximation ON	OFF	1
A1 to A11 *4	Linearizer approximation input 1 to 11	-5.00 to 105.00 %	0.00 %	1
B1 to B11 *4	Linearizer approximation output 1 to 11	-5.00 to 105.00 %	0.00 %	1

*1 This screen is not displayed in the case of RTD and TC input.

*2 This screen is not displayed in the case of voltage and current input.

*3 This screen is displayed only in the case of TC input.

*4 This screen is displayed only in the case of RTD and TC input.

*5 This screen is displayed only in the case of "square root function = ON".

18-9 Lock, etc. Screen Group (group 8)

Display Symbol	Description of Function	Setting Range	Initial Value	Lock
KLOCK	Key lock	OFF : Release LOCK1 : Other than SV, CONTROL LOCK2 : Other than SV LOCK3 : All	OFF	---
OUTPUT	Output mode	Single : 1-output Dual : 2-output	1-output: Single 2-output: Dual	1
IR COM	Front panel communication	ON : Enabled OFF : Disabled	ON	1
SV Limit_L *	SV limiter lower limit value	Within measuring range. Note that L<H	Measuring range lower limit value	1
SV Limit_H *	SV limiter higher limit value	Within measuring range. Note that L<H	Measuring range higher limit value	1
Time Unit	Time unit	H/M: Hours/minutes M/S: Minutes/second	H/M	1
PRG.Wait	Program control execution delay time	00h00m to 99h59m	00h00m	1
SO Mode	Input error mode	HOLD : Hold state RUN : RUN continued RESET : Reset state	HOLD	1
POWER ON	Power interruption compensation	RESET CONTINUE	RESET	1
ADV Mode	Advance mode	Step : Step Time : Time	Step	1
ADV Time	Advance time	00:00 to 99:59	00:00	1

19 PARAMETER SETUP RECORD SHEETS

Lots of parameters are set on this device before use.

Users will find these sheets will come in handy to restore a system in the event of a malfunction, for example, if they keep a detailed record of the product model No. they are using and the values set on this device.

We recommend that you fully utilize these record sheets by making a blank copy of these tables and entering the required values on the copied record sheet.

19-1 Product Model Code

FP23-	S□	□	□-	□□	□	□	□	□	□

19-2 CTRL EXEC Parameters

Item	Set value
AT	
MAN	
HLD	
ADV	
Start PTN	
PTN- Link Repts	
Link Format	
1st	
2nd	
3rd	
4th	
5th	
6th	
7th	
8th	
9th	
10th	
11th	
12th	
13th	
14th	
15th	
16th	
17th	
18th	
19th	
20th	

Item	Set value
FIX MODE	
FIX SV	
FIX PID	
FIX MOVE	
FIX EV1 Set Point	
FIX EV2 Set Point	
FIX EV3 Set Point	
FIX DO1 Set Point	
FIX DO2 Set Point	
FIX DO3 Set Point	
FIX DO4 Set Point	
FIX DO5 Set Point	
FIX DO6 Set Point	
FIX DO7 Set Point	
FIX DO8 Set Point	
FIX DO9 Set Point	
FIX DO10 Set Point	
FIX DO11 Set Point	
FIX DO12 Set Point	
FIX DO13 Set Point	

19-3 PROG STEP Parameters

PTN No. _____

Item	Set Value
Num. of STEP	
Start STEP	
Start SV	
PTN Repts	
Loop setup	
Start	
End	
Reps	
Guarantee Soak	
Zone	
Time	
PV Start	

Item	Set Value
EV1 Set Point	
EV2 Set Point	
EV3 Set Point	
DO1 Set Point	
DO2 Set Point	
DO3 Set Point	
DO4 Set Point	
DO5 Set Point	
DO6 Set Point	
DO7 Set Point	
DO8 Set Point	
DO9 Set Point	
DO10 Set Point	
DO11 Set Point	
DO12 Set Point	
DO13 Set Point	

STEP No. _____

Item	Set Value
SV	
Time	
PID	

STEP No. _____

Item	Set Value
SV	
Time	
PID	

STEP No. _____

Item	Set Value
SV	
Time	
PID	

STEP No. _____

Item	Set Value
SV	
Time	
PID	

STEP No. _____

Item	Set Value
SV	
Time	
PID	

STEP No. _____

Item	Set Value
SV	
Time	
PID	

STEP No. _____

Item	Set Value
SV	
Time	
PID	

STEP No. _____

Item	Set Value
SV	
Time	
PID	

STEP No. _____

Item	Set Value
SV	
Time	
PID	

STEP No. _____

Item	Set Value
SV	
Time	
PID	

PTN No. _____

Item	Set Value
Num. of STEP	
Start STEP	
Start SV	
PTN Repts	
Loop setup	
Start	
End	
Reps	
Guarantee Soak	
Zone	
Time	
PV Start	

Item	Set Value
EV1 Set Point	
EV2 Set Point	
EV3 Set Point	
DO1 Set Point	
DO2 Set Point	
DO3 Set Point	
DO4 Set Point	
DO5 Set Point	
DO6 Set Point	
DO7 Set Point	
DO8 Set Point	
DO9 Set Point	
DO10 Set Point	
DO11 Set Point	
DO12 Set Point	
DO13 Set Point	

STEP No. _____

Item	Set Value
SV	
Time	
PID	

STEP No. _____

Item	Set Value
SV	
Time	
PID	

STEP No. _____

Item	Set Value
SV	
Time	
PID	

STEP No. _____

Item	Set Value
SV	
Time	
PID	

STEP No. _____

Item	Set Value
SV	
Time	
PID	

STEP No. _____

Item	Set Value
SV	
Time	
PID	

STEP No. _____

Item	Set Value
SV	
Time	
PID	

STEP No. _____

Item	Set Value
SV	
Time	
PID	

STEP No. _____

Item	Set Value
SV	
Time	
PID	

STEP No. _____

Item	Set Value
SV	
Time	
PID	

19-4 PID Parameters

OUT1

PID No.	P	I	D	DF	MR	SF	ZN	OUT1L	OUT1H
01									
02									
03									
04									
05									
06									
07									
08									
09									
10									

OUT2

PID No.	P	I	D	DF	DB	SF	ZN	OUT1L	OUT1H
01									
02									
03									
04									
05									
06									
07									
08									
09									
10									

Zone PID

Item	Set Value
Zone PID1	
Zone HYS1	
AT Point	

19-5 EVENT/DO Parameters

Item	EV1	EV2	EV3	DO1	DO2	DO3
MD						
ACT						
DF						
IH						
DLY						
Log MD						
SRC1						
GATE1						
SRC2						
GATE2						

Item	DO4	DO5	DO6	DO7	DO8	DO9
MD						
ACT						
DF						
IH						
DLY						
Log MD				---	---	---
SRC			---	---	---	---
Time /Count			---	---	---	---

Item	DO10	DO11	DO12	DO13
MD				
ACT				
DF				
IH				
DLY				

19-6 DI/Options Parameters

Item	Set Value
DI1	
DI2	
DI3	
DI4	
DI5	
DI6	
DI7	
DI8	
DI9	
DI10	
Ao1MD	
Ao1 L	
Ao1 H	
Ao2MD	
Ao2 L	
Ao2 H	

Item	Set Value
HBA	
HLA	
HBM	
HB	
COM PROT	
ADDR	
BPS	
MEM	
DATA	
PARI	
STOP	
DELY	
CTRL	
BCC	

19-7 Control Output Parameters

Item	OUT1	OUT2
ACT		
RST		
ERR		
CYC		
Rate Limiter		

19-8 Unit/Measuring Range Parameters

Input setting

Item	Set Value
PV Bias	
PV Filter	
PV Slope	
RANGE	
Sc_L	
Sc_H	
UNIT	
DP	
Figure	
CJ	
SQ. Root	
Low Cut	
PMD	

Input point set values

Input point No.	Set Value	
	An	Bn
1		
2		
3		
4		
5		
6		
7		
8		
9		
10		
11		

19-9 Lock, etc. Parameters

Item	Set Value
KLOCK	
OUTPUT	
IR COM	

Item	Set Value
SV Limit_L	
SV Limit_H	
Time Unit	
PRG.Wait	
SO Mode	
POWER ON	
ADV Mode	
ADV Time	

20 SPECIFICATIONS

20-1 Display

- ◆ LED display Measured value (PV): 7-segment red LED 5 digits, height of characters 16 mm
Set value (SV) : 7-segment green LED 5 digits, height of characters 11 mm
- ◆ LCD display PTN No., STP No., Graph Pattern, control output value, various parameter displays
128 x 32 dot matrix liquid crystal display with yellow-green LED backlight
- ◆ Action display lamps 17 action statuses display. Lights on or blinks depending on the status

RUN	Green	Lights when control is executed, blinks when program execution is waiting
HLD	Green	Lights when program operation is stopped temporarily, blinks when it is stopped by input error
MAN	Green	Lights when manual control is in operation
FIX	Green	Lights when FIX (fixed value control) mode
EV1 to EV3	Orange	Lights when event output is ON
DO1 to DO5	Orange	Lights when DO output is ON
COM	Green	Lights when the communication mode is ON
EXT	Green	Lights when start pattern external switching is assigned
AT	Green	Lights when auto tuning is in standby, blinks when it is being executed
OUT1	Green	Control Output 1
OUT2	Green	Control Output 2
- ◆ Display accuracy $\pm(0.1\% + 1\text{digit})$ of measuring range (See Measuring Range Code Table for individual ranges.)

TC input	$\pm(0.1\% \text{ FS} + 1^\circ\text{C})$
Pt input	$\pm(0.1\% \text{ FS} + 0.1^\circ\text{C})$
mV, V input	$\pm(0.1\% \text{ FS} + 1\text{ digit})$
mA input	Depends on accuracy of externally attached resistor (When $\pm 0.1\% \text{ FS}$ accuracy is required, specify when ordering)
- ◆ Temperature range for maintaining display accuracy $23^\circ\text{C} \pm 5^\circ\text{C}$
- ◆ Display resolution 0.0001, 0.001, 0.01, 0.1, 1 (differs depending on measuring range)
- ◆ Sampling cycle 0.1 seconds (100 msec)

20-2 Settings

- ◆ Local setting By 10 front panel key switches
- ◆ SV setting range Same as measuring range (within setting limiter)
- ◆ Higher/lower setting limiter Any value in measuring range (lower limit value < higher limit value)

20-3 Input

- ◆ Universal-input, multi-range
 - Thermocouple input, RTD input, voltage input (mV, V), current input (mA)
- ◆ Thermocouple (TC)
 - Input type B, R, S, K, E, J, T, N, PLII, PR40-20, WRe5-26, {L, U (DIN43710)}, K, AuFe-Cr (Kelvin scale). For details, see Measuring Range Code Table.
 - Display range $\pm 10\%$ of measuring range.
 - Allowable range of external resistance 100 Ω max.
 - Input resistance Approx. 500 k Ω
 - Cold junction compensation
 - Selectable between internal and external cold junction compensation
 - Internal cold junction compensation accuracy $\pm 1^\circ\text{C}$ (in range of 18 to 28 $^\circ\text{C}$)
 - Burnout functions Standard feature (up scale)
- ◆ RTD input type
 - JIS Pt100 /JPt100 3-wire type. For details, see Measuring Range Code Table.
 - Display range $\pm 10\%$ of measuring range (not lower than -273.15 $^\circ\text{C}$)
 - Lead wire tolerance 10 Ω max. per wire
 - Amperage Approx. 1.1mA
- ◆ Voltage input (mV, V) type
 - 10 to 10, 0 to 10, 0 to 20, 0 to 50, 10 to 50, 0 to 100, -100 to 100 mV
 - 1 to 1, 0 to 1, 0 to 2, 0 to 5, 1 to 5, 0 to 10, -10 to 10 V
 - Universal-input, programmable scaling
 - For details, see Measuring Range Code Table.
 - Input resistance Approx. 500 k Ω
- ◆ Current input (mA) type
 - 4 to 20, 0 to 20 mA: universal-input and programmable scaling
 - For details, see Measuring Range Code Table.
 - Receiving resistance 250 Ω by external resistor
- ◆ Common functions
 - Sampling cycle 0.1 seconds (100 msec)
 - PV bias ± 10000 Unit
 - PV slope Input value x 0.500 to 1.500
 - PV filter OFF, 1 to 100 seconds
- ◆ Input operation
 - Possible with voltage or current input
 - Square root extraction operation
 - Low cut range 0.0 to 5.0% FS
 - Linearizer approximation
 - Number of input points: 11
- ◆ Isolation
 - Insulated between input and DI input, or input and various outputs.
 - Not insulated between input and the system, or input and CT input.

20-4 Control

- ♦ Control output 1-output specification, 2-output specification
- ♦ Control system (common to Control Output 1 and 2)
 - Expert PID control with auto tuning function
 - Multi-PID By PID Nos.01 to 10 (10 types)
 - Individual PID set on each step and FIX SV
 - Zone PID Selectable between individual PID and zone PID (max. 10 zones)
 - Proportional band (P) OFF, 0.1 to 999.9% (OFF: ON-OFF action)
 - Integral time (I) OFF, 1 to 6000 seconds (OFF: P or PD control)
 - Derivative time (D) OFF, 1 to 3600 seconds (OFF: P or PI control)
 - Manual reset (MR) -50.0 to 50.0% (available when I = OFF)
 - Dead band (DB) -19999 to 20000 Unit (Control Output 2)
 - Hysteresis (DF) 1 to 9999 Unit (at ON-OFF action, available when P = OFF)
 - Proportional cycle 1 to 120 seconds (at contact or SSR drive voltage output)
- ♦ Control output type/rating (common to Control Outputs 1 and 2)
 - Y: Contact 1c, contact rating 240 V AC/2.5A resistive load, 1A inductive load
 - I: Current 4 to 20 mA DC/load resistance 600Ω max.
 - P: SSR drive voltage 12 V±1.5 V DC/load current 30 mA max.
 - V: Voltage 0 to 10 V DC/load current 2 mA max.
 - Output accuracy ±0.5% FS (5 to 100% output/within accuracy maintaining temperature range)
 - Resolution Approx. 1/14000 (during current or voltage output)
- ♦ Operation/output update cycle 0.1 seconds (100 msec)
- ♦ Control output characteristics Reverse (for heating)/Direct (for cooling), Control Outputs 1 and 2 set individually (heating/cooling, 2-stage heating/2-stage cooling selectable in 2-output specification)
- ♦ Higher/lower output limiter setting range Higher limit/lower limit (set individually for each PID No.) 0.0 to 100.0% (lower limit < higher limit)
- ♦ Output rate-of-change OFF, 0.1 to 100.0%/seconds (set individually for control outputs limiter 1 and 2)
- ♦ Control output at error 0.0 to 100.0% (set individually for Control Outputs 1 and 2)
- ♦ Control output at standby 0.0 to 100.0% (set individually for Control Outputs 1 and 2)
- ♦ Manual control
 - Auto/manual switching Balanceless/bumpless action (simultaneous for Control Outputs 1 and 2)
 - Output setting range 0.0 to 100.0% set individually for Control Output 1 and 2
 - Setting resolution 0.1%
- ♦ Isolation Insulated between Control Output and the system.
Not insulated between Control Outputs.

20-5 Program Function

- ◆ Number of patterns Max. 20 patterns
- ◆ Number of steps Max. 400 steps
- ◆ Step time 0 minutes 0 seconds to 99 minutes 59 seconds or 0 hours 0 minutes to 99 hours 59 minutes
- ◆ Pattern execution counts
 - Repeatable to 9999 times max.
- ◆ Step loop count Repeatable to 9999 times max.
- ◆ Pattern link setting Connectable to 20 patterns max.
Executable to 9999 times max.
- ◆ Link execution setting Repeatable to 9999 times max.
- ◆ Program settings By front panel keys or communication
 - Level Same as measuring range
 - Time (1) 0 to 99 hours 59 minutes/step
 - Time (2) 0 to 99 minutes 59 seconds/step
 - Ramp settings Automatic computation by setting time and level
Ascend, descend, ramp control
 - Timer Sets the delay time for start of program operation
00 hours 00 minutes to 99 hours 59 minutes
- ◆ Setting resolution
 - Level 0.1 or 1 (varies according to measuring range)
 - Time 1 minute or 1 second
- ◆ Advance function Program moves to next step during operation.
- ◆ Hold function Progress of program time is stopped temporarily during operation.
- ◆ Time signal setting
 - Number of registrations Max. 8 points per pattern. (TS1~TS8) Assigned to event output or DO
 - Time (1) 0 to 99 hours 59 minutes
 - Time (2) 0 to 99 minutes 59 seconds
 - Resolution 1 minute or 1 second
- ◆ Guarantee soak zone When the program moves from a ramp step to a flat step, the program does not move to the next step if the PV value is not in the set zone range or is not more than the preset time.
 - Setting resolution 0 to 9999 Unit
 - Time (1) 0 to 99 hours 59 minutes
 - Time (2) 0 to 99 minutes 59 seconds

20-6 Event Output

◆ Number of outputs	Total 3; EV1 to EV3																																														
◆ Output rating	240 V AC/1.0A resistive load common to contact outputs (normally open contacts)																																														
◆ Output update cycle	0.1 seconds (100 msec)																																														
◆ Setting/selection	Individual setting (individual output), selectable from the following 27 types (to designate output)																																														
◆ Output types	<table border="0"> <tr><td>1) None</td><td>No action (no assignment)</td></tr> <tr><td>2) DEV Hi</td><td>Higher limit deviation alarm</td></tr> <tr><td>3) DEV Low</td><td>Lower limit deviation alarm</td></tr> <tr><td>4) DEV Out</td><td>Outside higher/lower limit deviation alarm</td></tr> <tr><td>5) DEV In</td><td>Inside higher/lower limit deviation alarm</td></tr> <tr><td>6) PV Hi</td><td>PV higher limit alarm</td></tr> <tr><td>7) PV Low</td><td>PV lower limit alarm</td></tr> <tr><td>8) SO</td><td>ON at scale over</td></tr> <tr><td>9) FIX</td><td>ON in FIX mode</td></tr> <tr><td>10) AT</td><td>ON during execution of auto tuning</td></tr> <tr><td>11) MAN</td><td>ON during manual control</td></tr> <tr><td>12) LOGIC</td><td>ON during logic operation output</td></tr> <tr><td>13) RUN</td><td>ON during control execution</td></tr> <tr><td>14) HLD</td><td>ON during program hold</td></tr> <tr><td>15) GUA</td><td>ON during guarantee soak</td></tr> <tr><td>16) STEP</td><td>ON during step move</td></tr> <tr><td>17) PRG. END</td><td>ON at program end</td></tr> <tr><td>18) TS1</td><td>ON during time signal 1</td></tr> <tr><td> </td><td></td></tr> <tr><td>25) TS8</td><td>ON during time signal 8</td></tr> <tr><td>26) Direct</td><td>ON during direct output by communication</td></tr> <tr><td>27) HBA</td><td>ON during Heater Break alarm action</td></tr> <tr><td>28) HLA</td><td>ON during Heater Loop alarm action</td></tr> </table>	1) None	No action (no assignment)	2) DEV Hi	Higher limit deviation alarm	3) DEV Low	Lower limit deviation alarm	4) DEV Out	Outside higher/lower limit deviation alarm	5) DEV In	Inside higher/lower limit deviation alarm	6) PV Hi	PV higher limit alarm	7) PV Low	PV lower limit alarm	8) SO	ON at scale over	9) FIX	ON in FIX mode	10) AT	ON during execution of auto tuning	11) MAN	ON during manual control	12) LOGIC	ON during logic operation output	13) RUN	ON during control execution	14) HLD	ON during program hold	15) GUA	ON during guarantee soak	16) STEP	ON during step move	17) PRG. END	ON at program end	18) TS1	ON during time signal 1			25) TS8	ON during time signal 8	26) Direct	ON during direct output by communication	27) HBA	ON during Heater Break alarm action	28) HLA	ON during Heater Loop alarm action
1) None	No action (no assignment)																																														
2) DEV Hi	Higher limit deviation alarm																																														
3) DEV Low	Lower limit deviation alarm																																														
4) DEV Out	Outside higher/lower limit deviation alarm																																														
5) DEV In	Inside higher/lower limit deviation alarm																																														
6) PV Hi	PV higher limit alarm																																														
7) PV Low	PV lower limit alarm																																														
8) SO	ON at scale over																																														
9) FIX	ON in FIX mode																																														
10) AT	ON during execution of auto tuning																																														
11) MAN	ON during manual control																																														
12) LOGIC	ON during logic operation output																																														
13) RUN	ON during control execution																																														
14) HLD	ON during program hold																																														
15) GUA	ON during guarantee soak																																														
16) STEP	ON during step move																																														
17) PRG. END	ON at program end																																														
18) TS1	ON during time signal 1																																														
25) TS8	ON during time signal 8																																														
26) Direct	ON during direct output by communication																																														
27) HBA	ON during Heater Break alarm action																																														
28) HLA	ON during Heater Loop alarm action																																														
◆ Setting range	Direct cannot be set for event, but for DO.																																														
	DEV Hi, Low -25000 to 25000 Unit																																														
	DEV Out, In 0 to 25000 Unit																																														
	PV Hi, Low Within measuring range																																														
Hysteresis	1 to 9999 Unit (when DEV or PV is selected)																																														
Action delay time	OFF, 1 to 9999 Unit (when DEV or PV is selected)																																														
Standby action	Selectable from 3 types (when DEV or PV is selected)																																														
	OFF No standby action																																														
	1 At power ON, or at RST -> RUN																																														
	2 At power ON, at RST -> RUN, or at execution SV is changed																																														
	3 At input error (SO), when action is OFF																																														
Output characteristics switching	Selectable between normally open and normally closed																																														
◆ Isolation	Insulated between event output and various I/O, or event output and the system.																																														

20-7 External Control Output (DO)

- ◆ Number of outputs 13 points in total; standard 5 and 8 optional

DO1 to DO3	Darlington output	3 points
DO4 to DO5	Open collector output	2 points
DO6 to DO13	Open collector output	8 points (optional)
- ◆ Output rating Open collector output 24 V DC/8 mA max., ON voltage 0.8V max.
Darlington output 24 V DC/50mA max., ON voltage 1.5V max.
- ◆ Output update cycle 0.1 seconds (100 msec)
- ◆ Setting/selection Individual setting (individual output), selectable.
Details are the same as those for event outputs.
(However, LOGIC can be assigned to only DO1 to DO5. Direct can be assigned to only DO6 to DO13 with communication option.)
Details of setting range, hysteresis, action delay time and stand by action are the same as those for event outputs.
- ◆ Output characteristics switching Normal open and normal close selectable
- ◆ Isolation Insulated between DO and various I/O, or DO and the system.
Not insulated between DOs.

20-8 External Control Input (DI)

- ◆ Number of inputs 10 points in total; standard 4 and 6 optional

DI1 to DI4	4 points
DI5 to DI10	6 points (optional)
- ◆ Input rating Non-voltage contact or open collector

Input specifications	
Photocoupler input	5 V DC, 2.5 mA max. Voltage application per 1 input
Input holding time	0.1 seconds (100 msec)
- ◆ Setting/selection Individual setting (individual input), selectable from 12 types

Input types	1) None	No action (no assignment)
	2) RUN/RST	Switching of Run/Reset (when ON: Run execution)
	3) RST	Forced Reset (when ON: Reset state)
	4) HLD	Control suspension/restart (when ON: suspension state)
	5) ADV	Execute advance (when ON: execute advance)
	6) FIX	Switching of FIX mode/Program mode (when ON: FIX mode)
	7) MAN	Switching of control output between auto/manual (when ON: manual)
	8) LOGIC	Logic operation input [exclusive port] (when ON: input ON)
	9) PTN2bit	Selection of start pattern No. by DI input (selectable from 3 patterns)
	10) PTN3bit	Selection of start pattern No. by DI input (selectable from 7 patterns)
	11) PTN4bit	Selection of start pattern No. by DI input (selectable from 15 patterns)
	12) PTN5bit	Selection of start pattern No. by DI input (selectable from 20 patterns)
- ◆ Isolation Insulated between DI and various I/O, or DI and the system
Not insulated between DIs.

20-9 Logic Operation Functions

- ◆ Number of logic Assignable to 8 points in total: EV1 to EV3 3 points, DO1 to DO5 5 points
DO4 and DO5 are exclusively for timer and counter operation.
- ◆ Logic operation inputs TS1 to TS8, and DI1 to DI10, can be assigned individually to source 1 and 2
- ◆ Input logic conversion Input logic conversion possible individually on source 1 and 2 (EV1 to EV3, DO1 to DO3 output)
 - 1) BUF By external control input logic
 - 2) INV Inversion of external control input logic
 - 3) FF Flip-flop logic operation of external control input
(When a time signal is assigned to a source, flip-flop cannot be set.)
- ◆ Logic operation (1) Logic operation output by source 1 and 2 (EV1 to EV3, DO1 to DO3 output)
 - 1) AND Output by logical product
 - 2) OR Output by logical sum
 - 3) XOR Output by exclusive OR
- ◆ Logic operation (2) Logic operation Output by source 1 (DO4, DO5 output)
 - 1) Timer operation OFF, 1 to 5000 seconds
 - 2) Counter operation OFF, 1 to 5000 counts

20-10 Heater Break Alarm (option)

- ◆ Alarm action HBA alarm ON when control output is ON and heater break is detected
HLA alarm ON when control output is OFF and heater loop error is detected
- Alarm detection HBA is detected at heater current \leq setting current value, when control output is ON
HLA is detected at heater current \geq setting current value, when control output is OFF
- Hysteresis at heater Break or loop error detection
0.2 A
- ◆ Current detection Heater current detection by external CT (supplied CT for exclusive use/single phase)
 - Current detection selection Selectable from Control Output 1 or Control Output 2 only when control output is Y or P
 - Sampling cycle 0.2 seconds (200 msec)
 - Minimum action confirmation time 0.2 seconds (200 msec) or longer (regardless of whether control output is ON or OFF)
- ◆ Current setting Heater break, heater loop alarm set individually
 - Setting range OFF, 0.1 to 50.0 A (OFF = suspension of alarm action)
 - Setting resolution 0.1 A
- ◆ Current display 0.0 to 55.0 A
 - Display accuracy 3% FS (sine wave 50 Hz)
 - Sampling cycle 0.2 seconds (200 msec)
 - Minimum action confirmation time 0.2 seconds (200 msec) or longer (regardless of whether control output is ON or OFF)
- ◆ Output Assigned to EVENT, DO output
 - Output hold Selectable between Lock mode and Real mode
- ◆ Isolation Insulated between CT input and DI input, or CT input and various outputs.
Not insulated between CT input and sensor input, or CT input and the system.

20-11 Analog Output (option)

- ◆ Number of Outputs Maximum 2, A_o1, A_o2 individual setting, individual output
Only A_o1 when sensor power supply (optional) is selected
- ◆ Output types Selectable from 5 types
PV, SV, DEV, OUT1, OUT2
- Output rating Individual selection (individual output)
0 to 10 mV DC/output resistance 10Ω
0 to 10 V DC/load current 2 mA max.
4 to 20mA DC/load resistance 300Ω max.
- ◆ Output accuracy ±0.1% FS (of indicated value)
- ◆ Output resolution Approx. 1/14000
- ◆ Output update cycle 0.1 second (100 msec)
- ◆ Output scaling PV, SV within measuring range
DEV, within -100.0 to 100.0%;
OUT1, OUT2 within 0.0 to 100.0%; reverse scaling possible
- ◆ Isolation Insulated between analog outputs and various I/O or analog outputs and
the system.
Not insulated between analog outputs (A_o1 and A_o2)

20-12 Sensor Power Supply (option)

- ◆ Number of outputs 1
Output from Analog Output 2 (A_o2) terminal
When the sensor power supply (SPS) is selected, Analog Output 2 (A_o2)
is unusable.
- ◆ Output rating 24 V DC/25 mA (max).
- ◆ Isolation Insulated between SPS and various I/O, SPS and analog output 1, or
SPS and the system.

20-13 Communication (option)

- ◆ Communication type RS-232C, RS-485
- ◆ Communication system
 - RS-232C 3-line half-duplex system
 - RS-485 2-line half-duplex multidrop (bus) system
- ◆ Communication distance
 - RS-232C 15 m max.
 - RS-485 500 m max. (depending on connection conditions)
- ◆ Number of connectable devices
 - RS-232C 1
 - RS-485 32 (including the host, differs depending on connection conditions)
- ◆ Synchronization system Start-stop synchronization
- ◆ Communication speed 2400, 4800, 9600, 19200 bps
- ◆ Communication (device) address
 - 1 to 98
- ◆ Communication delay time
 - 1 to 50 msec
- ◆ Communication memory mode
 - EEP, RAM, r_E
- ◆ Communication protocol (1) SHIMADEN protocol
 - Data length 7 bit, 8bit
 - Parity EVEN, ODD, NONE
 - Stop bit 1bit, 2bit
 - Control code STX_ETX_CR, STX_ETX_CRLF, @_: _CR
 - Checksum (BCC) ADD, ADD_two's cmp, XOR, None
 - Communication code ASCII
- ◆ Communication protocol (2) MODBUS ASCII mode
 - Data length 7 bit (fixed)
 - Parity EVEN, ODD, NONE
 - Stop bit 1bit, 2bit
 - Control code _CRLF
 - Error check LRC check
 - Function code 03H and 06H (Hex) supported
 - 1) 03H Read data
 - 2) 06H Write data
- ◆ Communication protocol (3) MODBUS RTU mode
 - Data length 8 bit (fixed)
 - Parity EVEN, ODD, NONE
 - Stop bit 1bit, 2bit
 - Control code None
 - Error check CRC 16
 - Function code 03H and 06H (Hex) supported
 - 1) 03H Read data
 - 2) 06H Write data

The contents of this Instruction Manual are subject to change without notice.

Temperature and Humidity Control Specialists

SHIMADEN CO., LTD.

<http://www.shimaden.co.jp/>

Head Office: 2-30-10 Kitamachi, Nerima-ku, Tokyo 179-0081 Japan
Phone: +81-3-3931-7891 Fax: +81-3-3931-3089 E-mail: exp-dept@shimaden.co.jp

PRINTED IN JAPAN