

Surface-Mounted Thermostat

ATH series

Special features

- Sturdy case (protection type IP 54))
- Microswitch
- Self-monitoring (STB/STW (STB)) in the event of a pressure drop
- Safety cut-out (STB/STW (STB))
- Tested according to DIN EN 14597
- Pressure Equipment Directive 2014/68/EU

Brief description

Thermostats control and monitor thermal processes. Instruments of the ATH series are available as temperature controllers TR, temperature monitors TW, safety temperature monitors STW (STB), and safety temperature limiters STB. When malfunctions occur, the STB places the system being monitored in a safe operating status.

Surface-mounted thermostats operate according to the fluid expansion principle – a microswitch is used as an electrical switching element.



ATH-1



ATH-70

Switching function

Temperature controller TR and temperature monitor TW

If the temperature on the temperature probe exceeds the setpoint value, the microswitch is activated by the transmission mechanics and the electrical circuit is opened or closed. If the temperature falls below the selected setpoint value (by the amount of the switching differential), the microswitch is reset to its initial position.

Restart lock on the safety temperature limiter STB

If the temperature on the temperature probe exceeds the set limit value, the electrical circuit is opened and the microswitch is mechanically locked.

The microswitch can be manually unlocked once the dangerous temperature drops by approx. 10 % of the scale range (approx. 15 % with a limit value setting > +350 °C).

Using the safety temperature monitor STW (STB) as a safety temperature limiter STB

The circuit following the thermostat must comply with DIN EN 14597 and VDE 0116.

Self-monitoring on the safety temperature limiter STB and the safety temperature monitor STW (STB)

If the measuring system is destroyed (i.e. if the expansion fluid escapes) the pressure in the membrane of the STB and STW (STB) drops and permanently opens the electrical circuit. Unlocking is then no longer possible.



The electrical circuit opens when cooling the probe of STW (STB) and STB down to the negative temperature range, but it then closes again if the temperature rises. The STB must be unlocked manually if the minimum probe temperature is exceeded.

The STW (STB) unlocks itself automatically

Approvals



Approvals

Types		Switching function	DIN registry no.	Tests	
With rigid thermowell	With capillary				
ATH-1	ATH-1	TR	TR 891	 <ul style="list-style-type: none"> - DIN EN 14597 - Pressure Equipment Directive 2014/68/EU <p style="text-align: center;">DGRL</p> (ATH-20 and ATH-70 only)	You will find Declarations of Conformity on the Internet at: www.jumo.net
ATH-2	ATH-2	TW	TW 892		
ATH-20	ATH-20	STW (STB)	STW (STB) 894 S		
ATH-70	ATH-70	STB	STB 895		
ATH-...		all	EAC-approval marks ^a TC RU C-DE.AB98.B.00348	Gost Norm AG 	Technical rules of the customs union Russia/Belarus/Kazakhstan

^a Russian documentation upon request

Technical data

Control ranges and temperature probes

Liquid-filled					
Type	Control range / limit value range in °C	Max. allowable probe temperature in °C	Maximum capillary length in mm	Probe length, dimension "L" in mm	
				Probe ø "d" in mm, ø "6" = standard	
				6	8
ATH-1	-20 to + 50	60	5000	141	92
ATH-2	-10 to + 40	50		185	115
	0 to + 50	60		185	115
	0 to +100	125		107	75
	+20 to + 90	115		138	91
	+20 to +120	140		106	75
	+20 to +150	175		88	65
	+30 to +110	135		125	84
	+50 to +200	230		101	72
	+50 to +250	290		73	54
	+50 to +300	345		63	49
	+50 to +350	405		53	- - -
	+60 to +130	150		135	90
ATH-20	+20 to +150	175		5000	77
ATH-70	+30 to +110	135	108		75
	+50 to +250	290	64		49
	+50 to +300	345	55		- - -
	+60 to +130	150	116		79
Gas-filled					
ATH-1	+20 to +400	460	1000	278	158
ATH-2	+20 to +500	575	2000	148	92
	+20 to +500	575	4000	202	119
ATH-20	+20 to +400	460	1000	176	106
ATH-70	+20 to +500	575	2000	127	81
	+20 to +500	575	4000	202	119

Capillary and temperature probe

Type	Scale limit value	Capillary	Temperature probe	Comments
ATH- . .	Up to 200 °C	Copper (Cu) ø 1.5mm Material-no. Cu-DHP	Copper (Cu) Material-no. Cu-DHP Hard soldered	-
	Up to 350 °C	Copper (Cu) ø 1.5mm Material-no. Cu-DHP	Stainless steel (CrNi) Material no. 1.4571 Hard soldered	-
	Up to 500 °C	Stainless steel (CrNi) ø 1.5mm	Stainless steel (CrNi) Material no. 1.4571 Welded	-
	Up to 350 °C	Stainless steel (CrNi) ø 1.5mm	Stainless steel (CrNi) Material no. 1.4571 Welded	Available at extra cost
Capillary length	1000 mm, max. 5000 mm as standard			
Minimum bending radius of the capillary	5 mm			

Electrical data

Switching element	ATH-1 ATH-2 ATH-20	ATH-70	ATH-70/574
	Microswitch with changeover contact	Microswitch with N/C contact and restart lock	Microswitch with N/C contact, restart lock, and additional signal contact
Max. switching capacity	AC 230 V +10 %, 10 (2) A, $\cos \varphi = 1$ (0.6) DC 230 V +10 %, 0.25A		
	With switching differential 1.5 % and 2 % AC 230 V +10 %, 6 (1.2) A, $\cos \varphi = 1$ (0.6)	-	-
	Gold-plated microswitch, extra code 702* (* for 3 %, 5 %, and 7 % switching differentials only) 24 V AC / DC, 0.1 A Contact resistance 2.5 to 10 m		
Contact reliability	To ensure a high switching reliability, we recommend a minimum load of: With silver contacts: AC / DC = 24 V, 100 mA		
		For gold-plated contacts (extra code"702"): AC / DC = 10 V, 5 mA	

Operating data

Switching differential in % of the control range / limit value range	Switching function	With liquid-filled measuring system				
		Nominal value	Possible actual value			
	TR, TW		3	3 max. 4	Standard	
			6	6 max. 8	Upon request	
			1.5	1 max. 2	Extra cost	
		With gas-filled measuring system				
			5	4 max. 8	Standard	
			9	8 max. 12	Upon request	
		2	1.5 max. 2.5	Extra cost		
	STW (STB)	With liquid-filled measuring system				
			5	4 max. 6	Standard	
			9	8 max. 11	Upon request	
		2	1 max. 3	Extra cost		
With gas-filled measuring system						
		7	5 max. 12	Standard		
		9	8 max. 16	Upon request		
		2	1.5 max. 3	Extra cost		
Switching point accuracy in % of the control range / limit value range	TR, TW: In the upper third of the scale ± 1.5 %, at scale beginning ± 6 % STB, STW (STB): In the upper third of the scale +0/-5 %, at scale beginning +0/-10 %					
Ambient temperature influence based on the control range / limit value range	When the ambient temperature on the case deviates from the calibration ambient temperature of 22 °C, a switching point offset occurs. Higher ambient temperatures = lower switching point Lower ambient temperature = higher switching point					
	Surface-mounted thermostats with scale limit value					
	< 200 °C		+ 200 °C ≤ 350 °C		> 350 °C ≤ 500 °C	
	TR / TW	STB/STW (STB)	TR / TW	STB/STW (STB)	TR / TW STB/STW (STB)	
	Influence on the switching head					
	0.08 %/K	0.17 %/K	0.06 %/K	0.13 %/K	0.14 %/K 0.12 %/K	
Influence on the capillary per meter						
0.047 %/K	0.054 %/K	0.09 %/K	0.11 %/K	0.04 %/K 0.03 %/K		
Admissible storage temperature	-50 to +80 °C or up to max. permissible ambient temperature (see nameplate)					
Admissible ambient temperature during use	see nameplate					
Rated position (NL)	According to DIN 16 257, NL 0 to NL 90 (different rated positions (NL) upon request)					

Case

Standard	Case lid: polycarbonate, shock resistant Case bottom section: aluminum die casting, painted	Color: pebble gray RAL 7032 Color: anthracite gray RAL 7015
Extra code "701"	Case lid made of aluminum die casting, painted	Color: pebble gray RAL 7032
Setpoint value adjustment	ATH-1: Switching point can be adjusted externally with the rotary knob	ATH-2, ATH-20, ATH-70 Switching point can be adjusted with a screwdriver once the case lid has been removed
Protection type	Design 1 + 2: EN 60529-IP54	
Cable inlet	Standard: self-sealing grommet M20 × 1.5, sealing range 8 to 10 mm	
Weight	Approx. 0.5 kg	
Switching head mounting ATH- . series with capillary	Standard	Screw connection with counter nut M18 × 1 on the case spigot, capillary exit on the case spigot
	Extra code	
	711	With 2 screws through the case bottom section, lateral capillary exit on the case, lid and bottom part made of plastic
	764	Mounting flange made of steel sheet, capillary exit on the case spigot
	248	Wall mount

Process connection*

Series ATH- with rigid thermowell	Scale limit value <u>up to</u> 150 °C protection tube "20"	Scale limit value <u>exceeding</u> 150 °C protection tube "30"
	Screw-in sleeve with screw-in spigot G 1/2 form A according to DIN 3852/2	Screw-in sleeve with screw-in spigot G 1/2 form A according to DIN 3852/2 and intermediate piece, to ensure that the max. admissible ambient temperature of is not exceeded on the case
Type ATH- With capillary	Plain cylindrical probe "10" (standard)	
	Screw-in protection tube "20" (upon request)	
	Screw-in sleeve with screw-in spigot G 1/2 form A acc. to DIN 3852/2 and clamping piece with fixing screw to lock the probe in place	
Material	Protection tube "20"	Protection tube "30"
	Up to +150 °C CuZn as standard over +150 °C CrNi	Above +150 °C CrNi
Insertion length S	Standard lengths: 100, 120, 150, 200, or 300 mm different lengths upon request	
Immersion tube Ø	D = 8 mm, D = 10 mm	

* For different process connections and protection tube refer to data sheet 606710.

Wiring diagrams

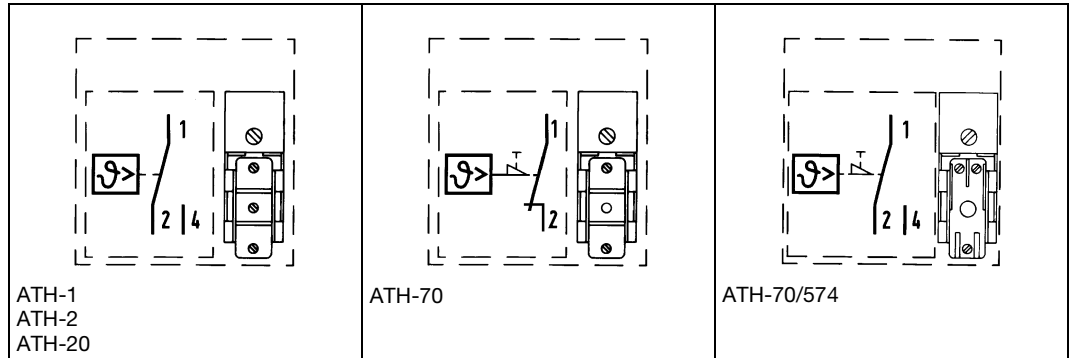

Dimensions, versions with rigid thermowell

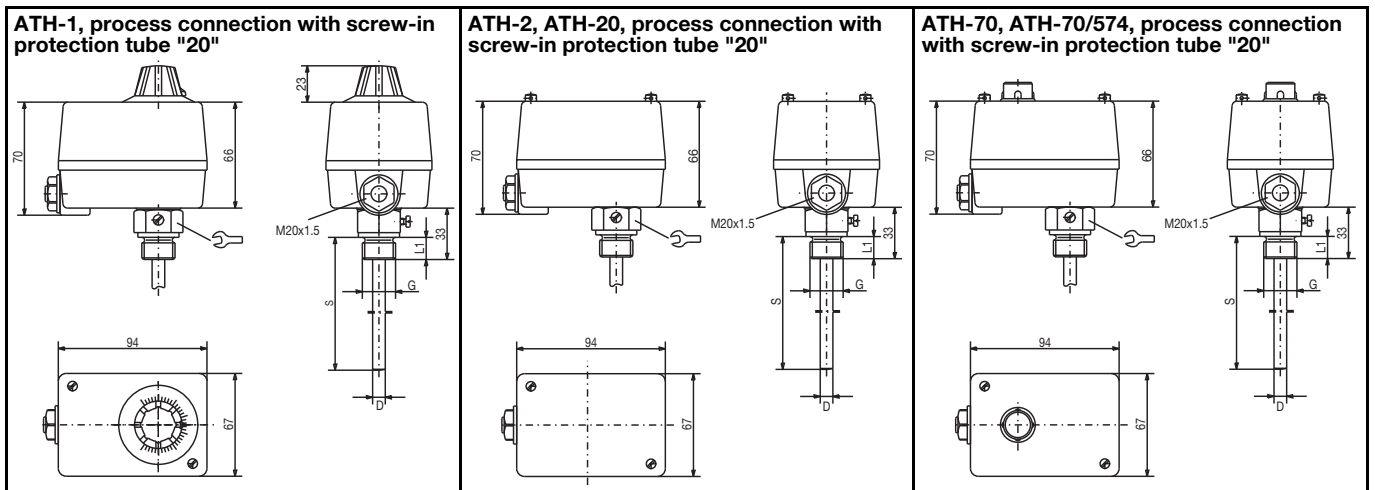

Process connection with screw-in protection tube "30" and intermediate piece for scale limit value above +150 °C:

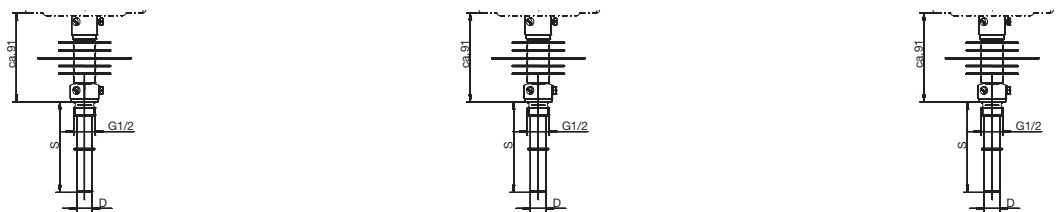

Process connection with protection tube "31" screw-in protection tube with intermediate piece, open:

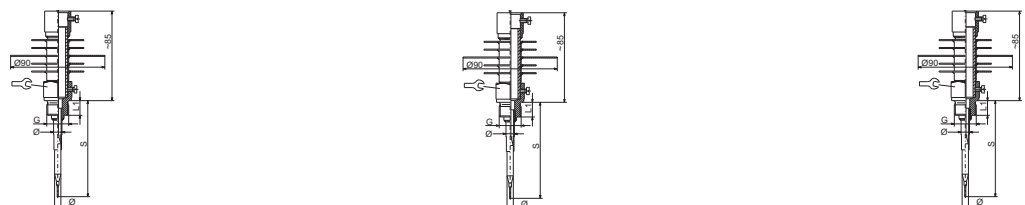

Stock versions with rigid thermowell

Temperature controller (TR)

(delivery within 3 working days after receipt of order)

Part no.	Type	Control range / limit value range °C	Switching differential %	Process connection screw-in tube	Immersion tube Ø x length mm
60001517	ATH-1	-10 to + 40	3-4	"20" G ¹ / ₂	8 x 200
60000634	ATH-1	0 to + 50	1.5		15 x 100 CrNi
60001548	ATH-1	0 to +100	3-4		8x120 CrNi
60001125	ATH-1	0 to +100	3-4		8x150
60000174	ATH-1	0 to +100	1.5		8 x 200
60001126	ATH-1	0 to +100	3-4		8 x 200
60000481	ATH-1	+20 to +150	3-4		8x100
60001035	ATH-1	+20 to +150	3-4		8 x 200
60001127	ATH-1	+20 to +150	3-4		8x300
60003316	ATH-1	+50 to +200	3-4		"30" G ¹ / ₂
60003317	ATH-1	+50 to +300	3-4	8x150 CrNi	
60003318	ATH-1	+20 to +500	5	8x200 CrNi	

Stock versions with rigid thermowell

Temperature monitor (TW)

(delivery within 3 working days after receipt of order)

Part no.	Type	Control range / limit value range °C	Switching differential %	Process connection screw-in tube	Immersion tube Ø x length mm
60001135	ATH-2	-10 to + 40	3-4	"20" G ¹ / ₂	8 x 200
60001549	ATH-2	0 to + 50	1.5		15 x 100 CrNi
60001128	ATH-2	0 to + 50	3-4		8 x 200
60000177	ATH-2	+20 to + 90	1.5		15x100
60000959	ATH-2	+20 to + 90	6-8		15x100
60001129	ATH-2	+20 to + 90	3-4		8x150
60001552	ATH-2	0 to +100	3-4		8x120 CrNi
60000179	ATH-2	0 to +100	3-4		8x150
60001039	ATH-2	0 to +100	3-4		8 x 200
60001130	ATH-2	0 to +100	3-4		8x300
60001551	ATH-2	+20 to +150	3-4		8x100 CrNi
60001554	ATH-2	+20 to +150	3-4		8x200 CrNi
60000182	ATH-2	+20 to +150	3-4		8x300
60003319	ATH-2	+50 to +200	3-4	"30" G ¹ / ₂	8x120 CrNi
60001556	ATH-2	+50 to +300	3-4		8x150 CrNi
60003322	ATH-2	+20 to +500	5		8x200 CrNi

Safety temperature monitor STW (STB)

(delivery within 3 working days after receipt of order)

Part no.	Type	Control range / limit value range °C	Switching differential %	Process connection screw-in tube/ weld-in tube	Immersion tube Ø x length mm
60001478	ATH-20	+20 to +150	4-6	"20" G ¹ / ₂	8x150
60003323	ATH-20	+50 to +300	5	"30" G ¹ / ₂	8x200 CrNi
60002217	ATH-20	+50 to +350	4-6	"46" G ³ / ₄	170 steel, conical
60003324	ATH-20	+20 to +500	7	"31" G ¹ / ₂	8x200 CrNi

Stock versions with rigid thermowell

Safety temperature limiter (STB)

(delivery within 3 working days after receipt of order)

Part no.	Type	Control range / limit value range °C	Switching differential %	Process connection screw-in tube/ weld-in tube	Immersion tube Ø x length mm
60001043	ATH-70	+ 30 to +110	--	"20" G ¹ / ₂	8 x 200
60000189	ATH-70	+ 30 to +110	--		8x300
60001044	ATH-70	+ 60 to +130	--		8x150
60000190	ATH-70	+ 60 to +130	--		8 x 200
60003325	ATH-70	+130 to +200	--	"30" G ¹ / ₂	8x150 CrNi
60003327	ATH-70	+ 50 to +300	--		8x200 CrNi
60001524	ATH-70/574	+ 30 to +110	--	"20" G ¹ / ₂	8x150
60001522	ATH-70/574	+ 20 to +150	--		8 x 200
60003328	ATH-70/574	+ 50 to +300	--	"30" G ¹ / ₂	8 x 200 CrNi
60002218	ATH-70/574	+ 50 to +350	--	"46" G ³ / ₄	170 steel, conical
60003329	ATH-70/574	+ 20 to +500	--	"31" G ¹ / ₂	8 x 200 CrNi
60001476	ATH-70/574	+ 20 to +500	--	"30" G ¹ / ₂	8x200 CrNi

Dimensions, versions with capillary

<p>ATH-1, process connection "10" plain cylindrical probe</p>	<p>ATH-2, ATH-20, process connection "10" plain cylindrical probe</p>
<p>ATH-70, ATH-70/574, process connection "10" plain cylindrical probe</p>	<p>ATH-20/r, ATH-70/r, process connection "42" plain cylindrical probe with weld-in tube G 3/4</p>

Stock versions with capillary

Temperature controller (TR)

(delivery within 3 working days after receipt of order)

Part no.	Type	Control range / limit value range °C	Switching differential %	Capillary mm	Process connection	Probe ø × length mm
60001134	ATH-1	-10 to + 40	3-4	1000	"10" Plain cylindrical probe	6x185
60001004	ATH-1	0 to +100	3-4	1000		6x107
60000955	ATH-1	+20 to +150	3-4	1000		6 x 88
60001133	ATH-1	+50 to +300	3-4	1000		6x 63
60002113	ATH-1	+20 to +500	5	1000		6x148

Temperature monitor (TW)

(delivery within 3 working days after receipt of order)

Part no.	Type	Control range / limit value range °C	Switching differential %	Capillary mm	Process connection	Probe ø × length mm
60000482	ATH-2	0 to + 50	3-4	1000	"10" Plain cylindrical probe	6x185
60000962	ATH-2	0 to +100	3-4	1000		6x107
60001212	ATH-2	0 to +100	3-4	2000		6x107
60000963	ATH-2	+20 to +150	3-4	1000		6 x 88
60001210	ATH-2	+20 to +150	3-4	2000		6 x 88
60000187	ATH-2	+50 to +200	3-4	1000		6x101
60001038	ATH-2	+50 to +300	3-4	1000		6x 63
60001208	ATH-2	+50 to +300	3-4	2000		6x 63
60002122	ATH-2	+20 to +500	5	1000		6x148

Safety temperature monitor STW (STB)

and safety temperature limiter (STB)

(delivery within 3 working days after receipt of order)

Part no.	Type	Control range / limit value range °C	Switching differential %	Capillary mm	Process connection	Probe ø × length mm
60002261	ATH-20/r	+ 20 to +500	7	4000	"42" G ³ / ₄ *	200
60001206	ATH-70	+ 30 to +110	--	2000	"10" Plain cylindrical probe	6x108
60001205	ATH-70	+ 20 to +150	--	2000		6x 77
60001525	ATH-70/574	+ 20 to +150	--	1000		6x 77
60001204	ATH-70	+ 50 to +200	--	2000		6x 85
60001290	ATH-70/574	+ 50 to +200	--	1000		6x 85
60001191	ATH-70	+ 50 to +300	--	2000		6x 55
60001528	ATH-70/574	+ 50 to +300	--	1000		6x 55
60002088	ATH-70/574	+ 20 to +500	--	1000		6x127
60002099	ATH-70/574	+ 20 to +500	--	2000		6x127
60002262	ATH-70/574/711	+ 20 to +500	--	4000		"42" G ³ / ₄ *

* Weld-in tube

Order details

(Please observe our stock versions and specify the parts no.)

Surface-mounted thermostat, ATH series

Order code (1) Basic type

603021 Surface-mounted thermostat, ATH series

(2) Basic type extensions

01	ATH-1	Temperature controller (TR)
02	ATH-2	Temperature monitor (TW)
20	ATH-20	Safety temperature monitor STW (STB)
70	ATH-70	Safety temperature limiter (STB)

(3) Design type

1	ATH with rigid thermowell
2	ATH with capillary

(4) Control ranges / limit value ranges °C

014	-20 to + 50 (only for TR and TW)
016	-10 to + 40 (only for TR and TW)
021	0 to + 50
025	0 to +100
041	+20 to + 90
042	+20 to +120
043	+20 to +150
045	+20 to +400
046	+20 to +500
052	+30 to +110
062	+50 to +200
063	+50 to +250
064	+50 to +300
066	+60 to +130

(5) Switching differential

00	Without switching differential (-70 STB)	
15	1.5 % of the scale range	(only for TR + TW)
20	2 % of the scale range	(only for STW (STB))
30	3 % of the scale range	(only for TR + TW)
50	5 % of the scale range	(only for TR + TW + STW (STB))
60	6 % of the scale range	(only for TR + TW)
70	7 % of the scale range	(only for STW (STB))
90	9 % of the scale range	(only for STW (STB))

(6) Capillary length

0	ATH without capillary
1000	1000 mm
2000	2000 mm
3000	3000 mm
4000	4000 mm
5000	5000 mm
....	(Special length, specifications in plain text)





(7) Capillary material

00	ATH without capillary
40	Cu (Copper)
20	CrNi (Stainless steel)

Order details

Surface-mounted thermostat, ATH series

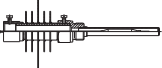
Order code (8) Process connection (PA)¹

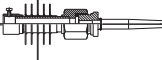
10	Plain cylindrical probe (only for ATH)	
20	Screw-in protection tube	
30	Screw-in protection tube with intermediate piece	
31	Screw-in protection tube with intermediate piece, open	
42	Weld-in sleeve for union nut, conical	
46	Welding sleeve for union nut with intermediate piece, conical	

(9) Thread of process connection¹

00	Without thread (process connection 10)
13	External thread G 1/2

(10) Material of process connection

00	Only with process connection 10
46	CuZn (Brass)
20	CrNi (Stainless steel 1.4571)

(11) Insertion length "S" (immersion tube length)

000	ATH without protection tube
100	100 mm
120	120 mm
150	150 mm
200	200 mm
300	300 mm
400	400 mm
...	... Special length, specifications in plain text

(12) Diameter "D" (immersion tube diameter)

00	ATH without protection tube
8	8 mm
10	10 mm

(13) Diameter "d" (probe diameter)

6	6 mm
8	8 mm

(14) Extra codes²

000	Without extra code
248	Wall mount
574	Microswitch with changeover contact, restart lock only for STB
701	Case lid made of aluminum diecasting (not with extra code "711")
702	Snap-action switch contact, gold-plated (only with switching differential 3 %, 5 %, and 7 % and STB)
711	Switching head mounting with 2 screws through the case bottom section, lateral capillary exit on the case, lid, and bottom section made of plastic
764	Mounting flange made of steel sheet, capillary exit on the case spigot

Order code

(1)	(2)	(3)	(4)	(5)	(6)	(7)	(8)	(9)	(10)	(11)	(12)	(13)	(14)											
603021	/	..	-	.	-	...	-	..	-	...	-	..	-	..	-	..	-	...	/	...	,	...	,	...

Order example

603021	/	70	-	1	-	043	-	00	-	0	-	00	-	20	-	13	-	20	-	100	-	8	-	6	/	574 ²
--------	---	----	---	---	---	-----	---	----	---	---	---	----	---	----	---	----	---	----	---	-----	---	---	---	---	---	------------------

¹ For other connection types and protection tube, see data sheet 606710.

² List extra codes in sequence, separated by commas.