



Outdoor LoRaWAN[®] Gateway

UG67

User Guide



Preface

Thanks for choosing Milesight UG67 LoRaWAN® gateway. UG67 delivers tenacious connection over network with full-featured design such as automated failover/failback, extended operating temperature, dual SIM cards, hardware watchdog, VPN, Gigabit Ethernet and beyond.

This guide shows you how to configure and operate the UG67 LoRaWAN® gateway. You can refer to it for detailed functionality and gateway configuration.

Readers

This guide is mainly intended for the following users:

- Network Planners
- On-site technical support and maintenance personnel
- Network administrators responsible for network configuration and maintenance

© 2011-2022 Xiamen Milesight IoT Co., Ltd.

All rights reserved.

All information in this user guide is protected by copyright law. Whereby, no organization or individual shall copy or reproduce the whole or part of this user guide by any means without written authorization from Xiamen Milesight IoT Co., Ltd.

Related Documents

Document	Description
UG67 Datasheet	Datasheet for UG67 LoRaWAN® gateway.
UG67 Quick Start Guide	Quick Installation Guide for UG67 LoRaWAN® gateway.

Declaration of Conformity

UG67 is in conformity with the essential requirements and other relevant provisions of the CE, FCC, and RoHS.



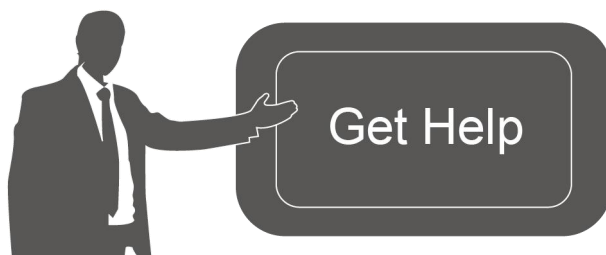

For assistance, please contact
 Milesight technical support:
 Email: iot.support@milesight.com
 Tel: 86-592-5085280
 Fax: 86-592-5023065
 Address: Building C09, Software
 Park III, Xiamen 361024,
 China

Revision History

Date	Doc Version	Description
Dec. 31, 2020	V1.0	Initial version
Apr. 30, 2021	V1.1	<ol style="list-style-type: none"> 1. Support LoRaWAN® Class B 2. Add Node-RED feature 3. Add Noise-Analyzer feature 4. Add Multicast Groups feature 5. Add application examples
Aug. 24, 2021	V1.2	<ol style="list-style-type: none"> 1. Support Yeastar Workplace platform integration 2. Delete Package Forward status page 3. Phone & Email webpage update
Dec. 15, 2021	V1.3	<ol style="list-style-type: none"> 1. Add AS923-3&AS923-4 2. Change network server channel mask box to channel 3. Add device channel setting in profile
Feb. 23, 2022	V1.4	<ol style="list-style-type: none"> 1. Add batch backup 2. Login webpage update 3. Change default antenna type to external antenna 4. Adjust time of Class C ACK timeout
Jun. 1, 2022	V1.5	<ol style="list-style-type: none"> 1. Support VLAN Trunk client 2. Add System Name in SNMP 3. Add Use L2TP Peer DNS option

Contents

Chapter 1 Product Introduction	7
1.1 Overview	7
1.2 Advantages	7
1.3 Specifications	8
1.4 Dimensions (mm)	10
Chapter 2 Access to Web GUI	11
2.1 Wireless Access	11
2.2 Wired Access	12
Chapter 3 Web Configuration	15
3.1 Status	15
3.1.1 Overview	15
3.1.2 Cellular	16
3.1.3 Network	17
3.1.4 WLAN	18
3.1.5 VPN	19
3.1.6 Host List	20
3.2 LoRaWAN	21
3.2.1 Packet Forwarder	21
3.2.1.1 General	21
3.2.1.2 Radios	22
3.2.1.3 Noise Analyzer	24
3.2.1.4 Advanced	26
3.2.1.5 Custom	28
3.2.1.6 Traffic	28
3.2.2 Network Server	29
3.2.2.1 General	29
3.2.2.2 Application	31
3.2.2.3 Profiles	35
3.2.2.4 Device	37
3.2.2.5 Multicast Groups	40
3.2.2.6 Gateway Fleet	41
3.2.2.7 Packets	42
3.3 Network	45
3.3.1 Interface	45
3.3.1.1 Port	45
3.3.1.2 WLAN	48
3.3.1.3 Cellular	51
3.3.1.4 Loopback	54
3.3.1.5 VLAN Trunk	54
3.3.2 Firewall	55
3.3.2.1 Security	55

3.3.2.2 ACL	55
3.3.2.3 DMZ	57
3.3.2.4 Port Mapping	57
3.3.2.5 MAC Binding	58
3.3.3 DHCP	59
3.3.4 DDNS	60
3.3.5 Link Failover	61
3.3.5.1 SLA	61
3.3.5.2 Track	62
3.3.5.3 WAN Failover	63
3.3.6 VPN	64
3.3.6.1 DMVPN	64
3.3.6.2 IPSec	65
3.3.6.3 GRE	68
3.3.6.4 L2TP	69
3.3.6.5 PPTP	71
3.3.6.6 OpenVPN Client	73
3.3.6.7 OpenVPN Server	74
3.3.6.8 Certifications	76
3.4 System	78
3.4.1 General Settings	78
3.4.1.1 General	78
3.4.1.2 System Time	79
3.4.1.3 SMTP	81
3.4.1.4 Phone	81
3.4.1.5 Email	82
3.4.2 User Management	83
3.4.2.1 Account	83
3.4.2.2 User Management	83
3.4.3 SNMP	84
3.4.3.1 SNMP	84
3.4.3.2 MIB View	85
3.4.3.3 VACM	85
3.4.3.4 Trap	86
3.4.3.5 MIB	87
3.4.4 Device Management	87
3.4.5 Events	88
3.4.5.1 Events	88
3.4.5.2 Events Settings	89
3.5 Maintenance	91
3.5.1 Tools	91
3.5.1.1 Ping	91
3.5.1.2 Traceroute	91
3.5.1.3 Qxdmlog	92

3.5.2 Schedule	92
3.5.3 Log	92
3.5.3.1 System Log	93
3.5.3.2 Log Settings	93
3.5.4 Upgrade	94
3.5.5 Backup and Restore	95
3.5.6 Reboot	96
3.6 APP	97
3.6.1 Python	97
3.6.1.1 Python	97
3.6.1.2 App Manager Configuration	98
3.6.1.3 Python App	99
3.6.2 Node-RED	99
3.6.2.1 Node-RED	100
Chapter 4 Application Examples	101
4.1 Restore Factory Defaults	101
4.1.1 Via Web Interface	101
4.1.2 Via Hardware	102
4.2 Firmware Upgrade	102
4.3 Ethernet Connection	103
4.4 Cellular Connection	104
4.5 Wi-Fi Application Example	105
4.5.1 AP Mode	105
4.5.2 Client Mode	107
4.6 Packet Forwarder Configuration	108
4.7 Connect UG67 to Milesight IoT Cloud	110
4.8 Application Configuration	111
4.9 Device Configuration	114
4.10 Send Data to Device	115
4.11 Node-RED	117
4.11.1 Start the Node-RED	117
4.11.2 Send Data by Email	118

Chapter 1 Product Introduction

1.1 Overview

UG67 is a robust 8-channel outdoor LoRaWAN® gateway. Adopting SX1302 LoRa chip and high-performance quad-core CPU, UG67 supports connection with more than 2000 nodes. UG67 has line of sight up to 15 km and can cover about 2km in urbanized environment, which is ideally suited to smart office, smart building and many other outdoor applications.

UG67 supports not only multiple back-haul backups with Ethernet, Wi-Fi and cellular, but also has integrated mainstream network servers (such as The Things Industries, ChirpStack, etc.) and built-in network server and Milesight IoT Cloud for easy deployment.

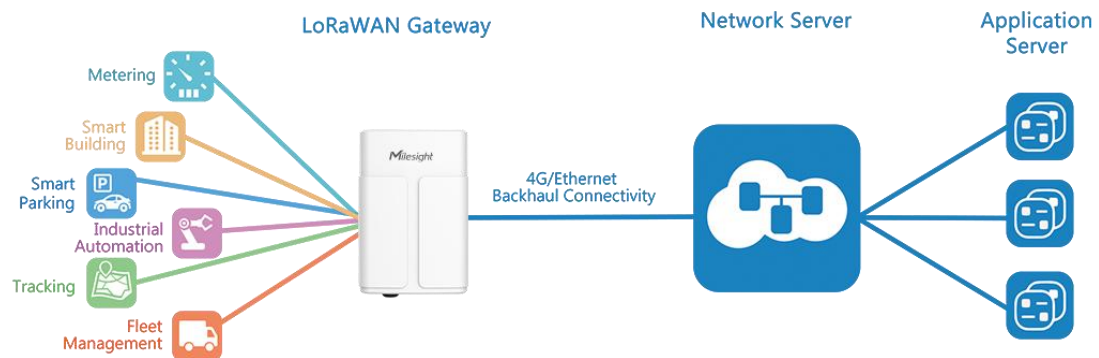

Figure 1-1

1.2 Advantages

Benefits

- Built-in industrial CPU and big memory
- Ethernet, 2.4GHz Wi-Fi and global 2G/3G/LTE options make it easy to get connected
- Embedded network server and compliant with several third party network servers
- MQTT, HTTP or HTTPS protocol for data transmission to application server
- Rugged enclosure, optimized for wall or pole mounting
- 3-year warranty included

Security & Reliability

- Automated failover/failback between Ethernet and Cellular
- Enable unit with security frameworks like IPsec/OpenVPN/GRE/L2TP/PPTP/ DMVPN

- Embedded hardware watchdog to automatically recover from various failure and ensure highest level of availability

Easy Maintenance

- Milesight DeviceHub provides easy setup, mass configuration, and centralized management of remote devices
- The user-friendly web interface design and various upgrading options help administrator to manage the device as easy as pie
- WEB GUI and CLI enable the admin to achieve quick configuration and simple management among a large quantity of devices
- Users can efficiently manage the remote devices on the existing platform through the industrial standard SNMP

Capabilities

- Link remote devices in an environment where communication technologies are constantly changing
- Industrial quad core 64-bit ARM Cortex-A53 processor, high-performance operating up to 1.5GHz with low power consumption, and 8GB eMMC available to support more applications
- Support wide operating temperature ranging from -40°C to 70°C/-40°F to 158°F

1.3 Specifications

Hardware System	
CPU	Quad-core 1.5GHz, 64-bit ARM Cortex-A53
Memory	8 GB eMMC Flash, 512 MB DDR4 RAM
LoRaWAN	
Antenna	2 × Internal Antennas + 2 × 50 Ω N-Female External Connectors
Channel	8
Frequency Band	CN470/IN865/EU868/RU864/US915/AU915/KR920/AS923-1&2&3&4
Sensitivity	-140dBm Sensitivity @292bps
Output Power	27dBm Max
Protocol	V1.0 Class A/Class B/Class C and V1.0.2 Class A/Class B/Class C
Ethernet	

Ports	1 × RJ-45 (PoE PD supported)
Physical Layer	10/100/1000 Base-T (IEEE 802.3)
Data Rate	10/100/1000 Mbps (auto-sensing)
Interface	Auto MDI/MDIX
Mode	Full or half duplex (auto-sensing)
Wi-Fi Interfaces	
Antenna	Fully Integrated and Internal Antenna
Standards	IEEE 802.11 b/g/n, 2.4 GHz
	802.11b: 18 dBm +/-2.0 dBm (11 Mbps)
	802.11g: 15 dBm +/-2.0 dBm (6 Mbps)
	802.11g: 15 dBm +/-2.0 dBm (54 Mbps)
Tx Power	802.11n@2.4 GHz: 14 dBm +/-2.0 dBm (MCS0_HT20)
	802.11n@2.4 GHz: 14 dBm +/-2.0 dBm (MCS7_HT20)
	802.11n@2.4 GHz: 13 dBm +/-2.0 dBm (MCS0_HT40)
	802.11n@2.4 GHz: 13 dBm +/-2.0 dBm (MCS7_HT40)
Cellular Interfaces (Optional)	
Antenna	Internal Antenna
SIM Slots	1
GPS	
Antenna	Internal Antenna
Sensitivity	-167dBm@Tracking, -149dBm@Acquisition, -161dBm@Re-acquisition
Position Accuracy	<2.5m CEP
Software	
Network Protocols	PPPoE, SNMP v1/v2c/v3, TCP, UDP, DHCP, DDNS, HTTP, HTTPS, DNS, SNTP, Telnet, SSH, MQTT, etc.
VPN Tunnel	DMVPN/IPsec/OpenVPN/PPTP/L2TP/GRE
Firewall	ACL/DMZ/Port Mapping/MAC Binding
Management	Web, CLI, SMS, On-demand dial up, DeviceHub, Milesight IoT Cloud, Yeastar Workplace Platform
App	Python SDK, Node-RED
Power Supply and Consumption	
Power Supply	1. 1 × 802.3 af PoE Input 2. 12 VDC with M12 Connector

Consumption	Typical 3.6W, Max 4.8W
Physical Characteristics	
Ingress Protection	IP67
Dimensions	240 x 164 x 90.9 mm
Mounting	Wall or Pole Mounting
Others	
Reset Button	1 × RST
LED Indicators	1 × SYS, 1 × LoRa, 1 × LTE
Built-in	Watchdog, RTC, Timer
Environmental	
Operating Temperature	-40°C to +70°C (-40°F to +158°F)
Temperature	Reduced cellular performance above 60°C
Storage Temperature	-40°C to +85°C (-40°F to +185°F)
Ethernet Isolation	1.5 kV RMS
Relative Humidity	0% to 95% (non-condensing) at 25°C/77°F

1.4 Dimensions (mm)

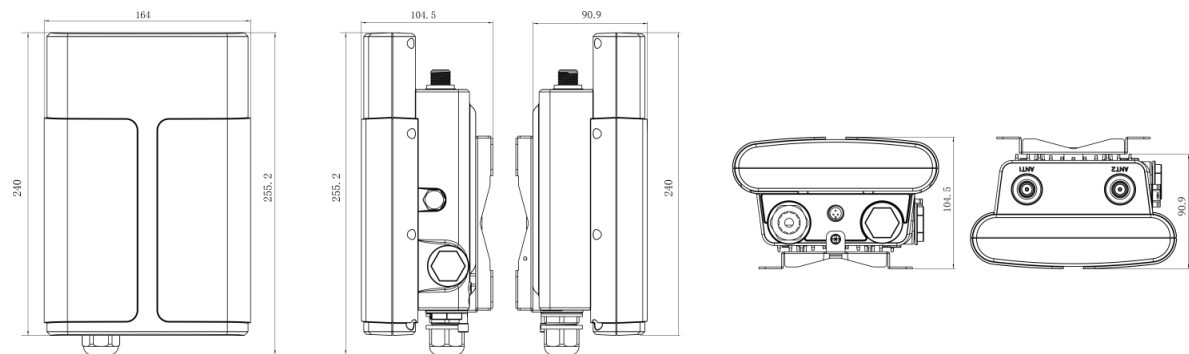

Chapter 2 Access to Web GUI

This chapter explains how to access to Web GUI of the UG67.

Username: **admin**

Password: **password**

2.1 Wireless Access

1. Enable Wireless Network Connection on your computer and search for access point **"Gateway_*****"** to connect it.
2. Open a Web browser on your PC (Chrome is recommended) and type in the IP address **192.168.1.1** to access the web GUI.
3. Enter the username and password, click "Login".



! If you enter the username or password incorrectly more than 5 times, the login page will be locked for 10 minutes.

4. After logging the web GUI, follow the guide to complete the basic configurations. It's suggested that you change the password for the sake of security.

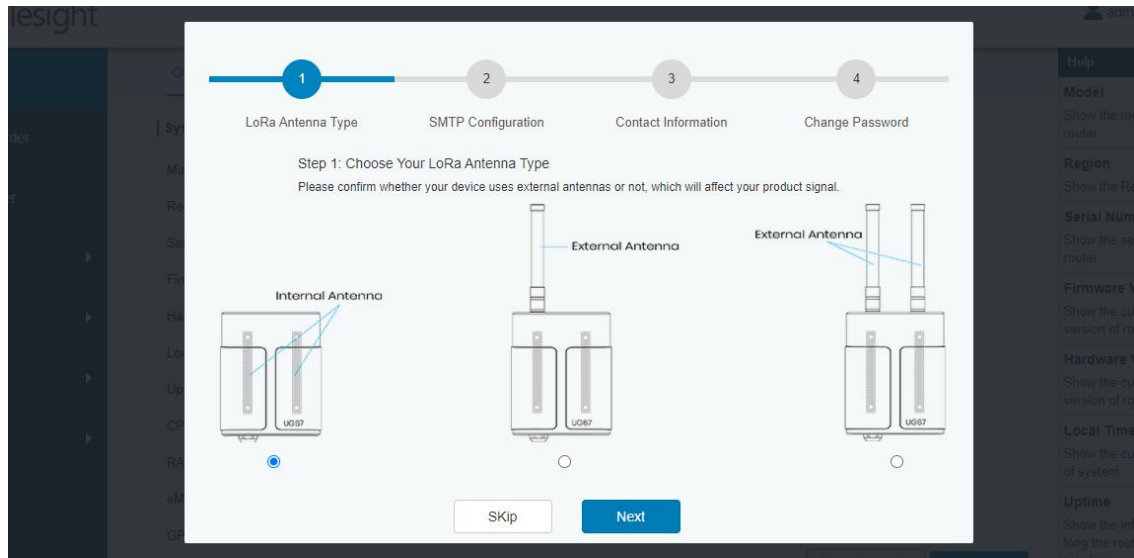

5. You can view system information and perform configuration of the gateway.

System Information	
Model	UG67-L00E-470M
Region	CN470
Serial Number	6222A3243835
Firmware Version	60.0.0.23
Hardware Version	V1.0
Local Time	2020-12-14 17:05:05 Monday
Uptime	4days,05:52:48
CPU Load	2%
RAM (Capacity/Available)	512MB/77MB(15.04%)
eMMC (Capacity/Available)	3.0G/2.7G(89.74%)
GPS	-

2.2 Wired Access

Connect PC to UG67 ETH port through PoE injector to access the web GUI of gateway. The following steps are based on Windows 10 system for your reference.

1. Go to "Control Panel" → "Network and Internet" → "Network and Sharing Center", then click "Ethernet" (May have different names).

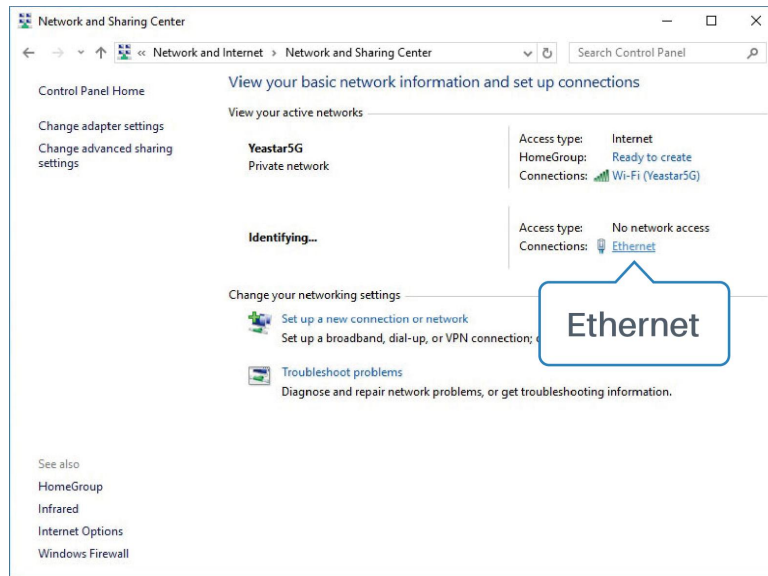

2. Go to “Properties” → “Internet Protocol Version 4(TCP/IPv4)” and select “Use the following IP address”, then assign a static IP manually within the same subnet of the gateway.

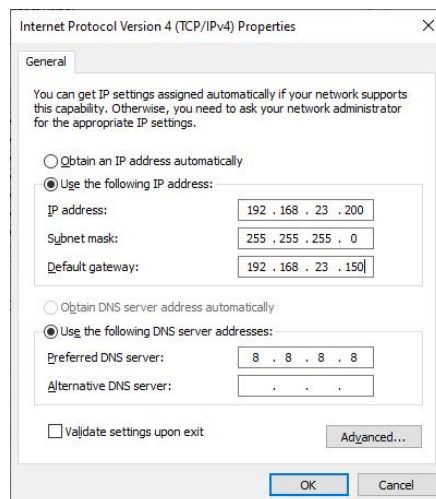

3. Open a Web browser on your PC (Chrome is recommended) and type in the IP address **192.168.23.150** to access the web GUI.

4. Enter the username and password, click “Login”.

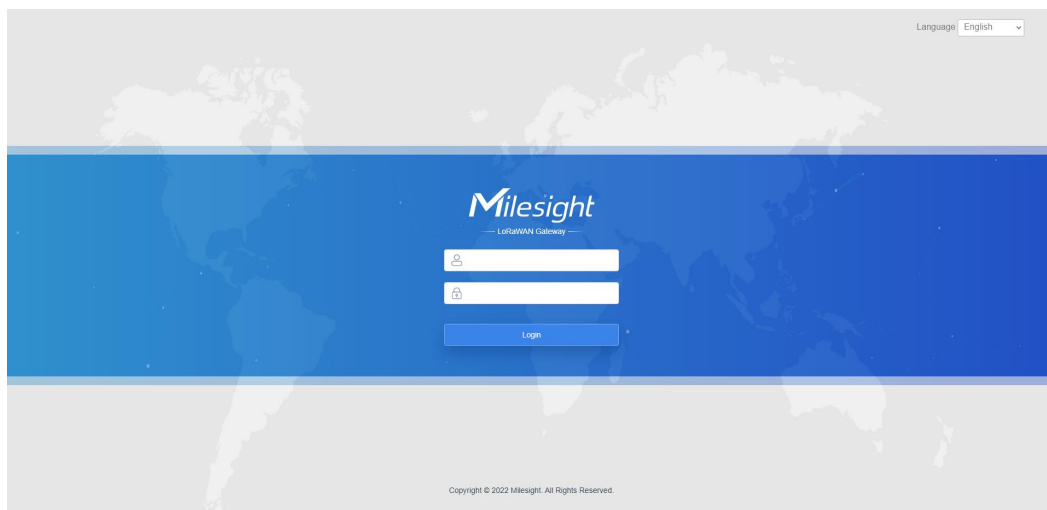

! If you enter the username or password incorrectly more than 5 times, the login page will be locked for 10 minutes.

5. After logging the web GUI, follow the guide to complete the basic configurations. It's suggested that you change the password for the sake of security.

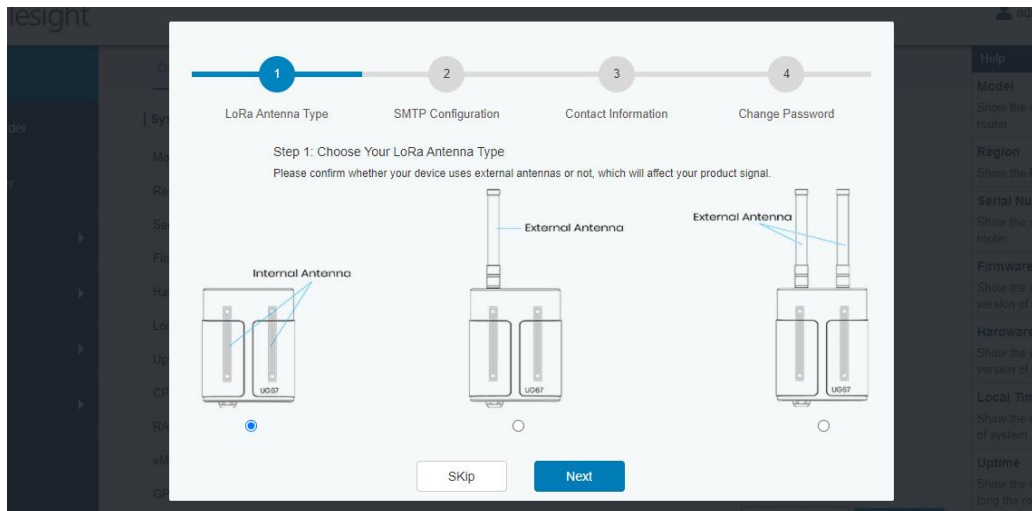

6. After guide complete, you can view system information and perform configuration of the gateway.

For your device security, please change the default password

Status Overview Packet Forward Cellular Network WLAN VPN Host List Help

Packet Forwarder

Network Server

Network

System

Maintenance

APP

System Information

Model	UG67-L00E-470M
Region	CN470
Serial Number	6222A3243835
Firmware Version	60.0.0.23
Hardware Version	V1.0
Local Time	2020-12-14 17:05:05 Monday
Uptime	4days,05:52:48
CPU Load	2%
RAM (Capacity/Available)	512MB/77MB(15.04%)
eMMC (Capacity/Available)	3.0G/2.7G(89.74%)
GPS	-

Manual Refresh Refresh

Model Show the model name of router.

Region Show the Region of router.

Serial Number Show the serial number of router.

Firmware Version Show the current firmware version of router.

Hardware Version Show the current hardware version of router.

Local Time Show the current local time of system.

Uptime Show the information on how long the router has been running.

Chapter 3 Web Configuration

3.1 Status

3.1.1 Overview

You can view the system information of the gateway on this page.

System Information	
Model	UG67-L00E-915M
Region	US915
Serial Number	6222A4983306
Firmware Version	60.0.0.33
Hardware Version	V1.1
Local Time	2021-01-06 10:37:17 Wednesday
Uptime	01:12:19
CPU Load	7%
RAM (Capacity/Available)	512MB/146MB(28.52%)
eMMC (Capacity/Available)	3.0G/2.8G(90.66%)
GPS	-

Figure 3-1-1-1

System Information	
Item	Description
Model	Show the model name of gateway.
Region	Show the LoRaWAN® frequency region of gateway.
Serial Number	Show the serial number of gateway.
Firmware Version	Show the currently firmware version of gateway.
Hardware Version	Show the currently hardware version of gateway.
Local Time	Show the currently local time of system.
Uptime	Show the information on how long the gateway has been running.
CPU Load	Show the current CPU utilization of the gateway.
RAM (Capacity/Available)	Show the RAM capacity and the available RAM memory.
eMMC (Capacity/Available)	Show the eMMC capacity and the available eMMC memory.
GPS	Show GPS data of the gateway.

Table 3-1-1-1 System Information

3.1.2 Cellular

You can view the cellular network status of gateway on this page.

Modem	
Status	Ready
Model	EC25
Version	EC25ECGAR06A07M1G
Signal Level	26asu (-61dBm)
Register Status	Registered (Home network)
IMEI	860425047368939
IMSI	460019425301842
ICCID	89860117838009934120
ISP	CHN-UNICOM
Network Type	LTE
PLMN ID	
LAC	5922
Cell ID	340db80

Figure 3-1-2-1

Modem Information	
Item	Description
Status	Show corresponding detection status of module and SIM card.
Model	Show the model name of cellular module.
Version	Show the version of cellular module.
Signal Level	Show the cellular signal level.
Register Status	Show the registration status of SIM card.
IMEI	Show the IMEI of the module.
IMSI	Show IMSI of the SIM card.
ICCID	Show ICCID of the SIM card.
ISP	Show the network provider which the SIM card registers on.
Network Type	Show the connected network type, such as LTE, 3G, etc.
PLMN ID	Show the current PLMN ID, including MCC, MNC, LAC and Cell ID.
LAC	Show the location area code of the SIM card.
Cell ID	Show the Cell ID of the SIM card location.

Table 3-1-2-1 Modem Information

Network	
Status	Connected
IP Address	10.53.241.18
Netmask	255.255.255.252
Gateway	10.53.241.17
DNS	218.104.128.106
Connection Duration	0 days, 00:04:26

Figure 3-1-2-2

Network Status	
Item	Description
Status	Show the connection status of cellular network.
IP Address	Show the IP address of cellular network.
Netmask	Show the netmask of cellular network.
Gateway	Show the gateway of cellular network.
DNS	Show the DNS of cellular network.
Connection Duration	Show information on how long the cellular network has been connected.

Table 3-1-2-2 Network Status

3.1.3 Network

On this page you can check the Ethernet port status of the gateway.

Overview	Cellular	Network	WLAN	VPN	Host List		
WAN							
Port	Status	Type	IP Address	Netmask	Gateway	DNS	Duration
eth 0	up	Static	192.168.22.112	255.255.255.0	192.168.22.1	8.8.8.8	02m 14s

Figure 3-1-3-1

Network	
Item	Description
Port	Show the name of the Ethernet port.
Status	Show the status of the Ethernet port. "Up" refers to a status that WAN is enabled and Ethernet cable is connected. "Down" means Ethernet cable is disconnected or WAN function is disabled.
Type	Show the dial-up type of the Ethernet port.
IP Address	Show the IP address of the Ethernet port.
Netmask	Show the netmask of the Ethernet port.

Gateway	Show the gateway of the Ethernet port.
DNS	Show the DNS of the Ethernet port.
Duration	Show the information about how long the Ethernet cable has been connected to the Ethernet port when the port is enabled. Once the port is disabled or Ethernet cable is disconnected, the duration will stop.

Table 3-1-3-1 WAN Status

3.1.4 WLAN

You can check Wi-Fi status on this page, including the information of access point and client.

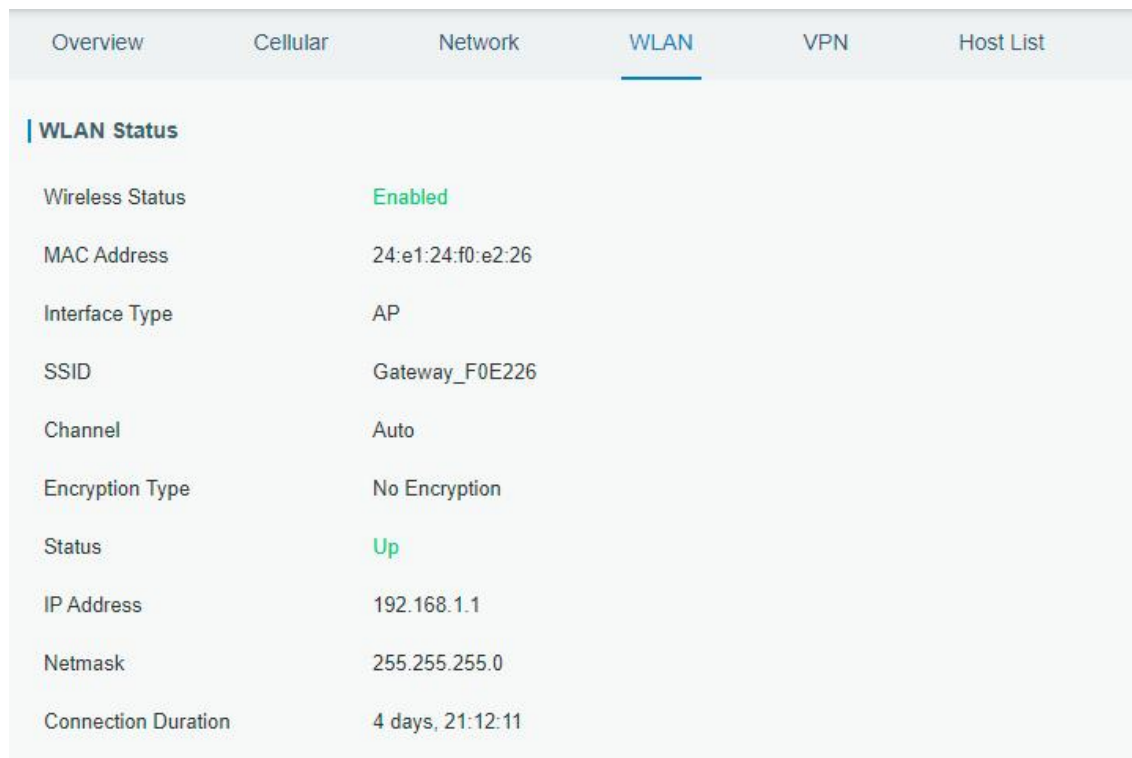

Overview	Cellular	Network	WLAN	VPN	Host List
WLAN Status					
Wireless Status	Enabled				
MAC Address	24:e1:24:f0:e2:26				
Interface Type	AP				
SSID	Gateway_F0E226				
Channel	Auto				
Encryption Type	No Encryption				
Status	Up				
IP Address	192.168.1.1				
Netmask	255.255.255.0				
Connection Duration	4 days, 21:12:11				

Figure 3-1-4-1

WLAN Status	
Item	Description
Wireless Status	Show the wireless status.
MAC Address	Show the MAC address.
Interface Type	Show the interface type, such as "AP" or "Client".
SSID	Show the SSID.
Channel	Show the wireless channel.
Encryption Type	Show the encryption type.
Status	Show the connection status.
IP Address	Show the IP address of the gateway.
Netmask	Show the wireless MAC address of the gateway.
Gateway	Show the gateway address in wireless network.
Connection Duration	Show information on how long the Wi-Fi network has been connected.

Table 3-1-4-1 WLAN Status

Associated Stations		
IP Address	MAC Address	Connection Duration

Figure 3-1-4-2

Associated Stations	
Item	Description
IP Address	Show the IP address of access point or client.
MAC Address	Show the MAC address of the access point or client.
Connection Duration	Show information on how long the Wi-Fi network has been connected.

Table 3-1-4-2 WLAN Status

3.1.5 VPN

You can check VPN status on this page, including PPTP, L2TP, IPsec, OpenVPN and DMVPN.

Overview	Cellular	Network	WLAN	VPN	Host List
PPTP Tunnel					
Name	Status	Local IP	Remote IP		
pptp_1	Disconnected	-	-		
pptp_2	Disconnected	-	-		
pptp_3	Disconnected	-	-		
L2TP Tunnel					
Name	Status	Local IP	Remote IP		
l2tp_1	Disconnected	-	-		
l2tp_2	Disconnected	-	-		
l2tp_3	Disconnected	-	-		

Figure 3-1-5-1

IPsec Tunnel				
Name	Status	Local IP	Remote IP	
ipsec_1	Disconnected	-	-	
ipsec_2	Disconnected	-	-	
ipsec_3	Disconnected	-	-	
OpenVPN Client				
Name	Status	Local IP	Remote IP	
openvpn_1	Disconnected	-	-	
openvpn_2	Disconnected	-	-	
openvpn_3	Disconnected	-	-	

Figure 3-1-5-2

GRE Tunnel			
Name	Status	Local IP	Remote IP
gre_1	Disconnected	-	-
gre_2	Disconnected	-	-
gre_3	Disconnected	-	-

DMVPN Tunnel			
Name	Status	Local IP	Remote IP
dmvpn	Disconnected	-	-

Figure 3-1-5-3

VPN Status	
Item	Description
Name	Show the name of the VPN tunnel.
Status	Show the status of the VPN tunnel.
Local IP	Show the local tunnel IP of VPN tunnel.
Remote IP	Show the remote tunnel IP of VPN tunnel.

Table 3-1-5-1 VPN Status

3.1.6 Host List

You can view the host information on this page.

Overview	Cellular	Network	WLAN	VPN	Host List
DHCP Leases					
IP		MAC		Lease Remaining Time	
MAC Binding					
IP			MAC		

Figure 3-1-6-1

Host List	
Item	Description
DHCP Leases	
IP Address	Show IP address of DHCP client
MAC Address	Show MAC address of DHCP client
Lease Time Remaining	Show the remaining lease time of DHCP client.
MAC Binding	
IP & MAC	Show the IP address and MAC address set in the Static IP

list of DHCP service.

Table 3-1-6-1 Host List Description

3.2 LoRaWAN

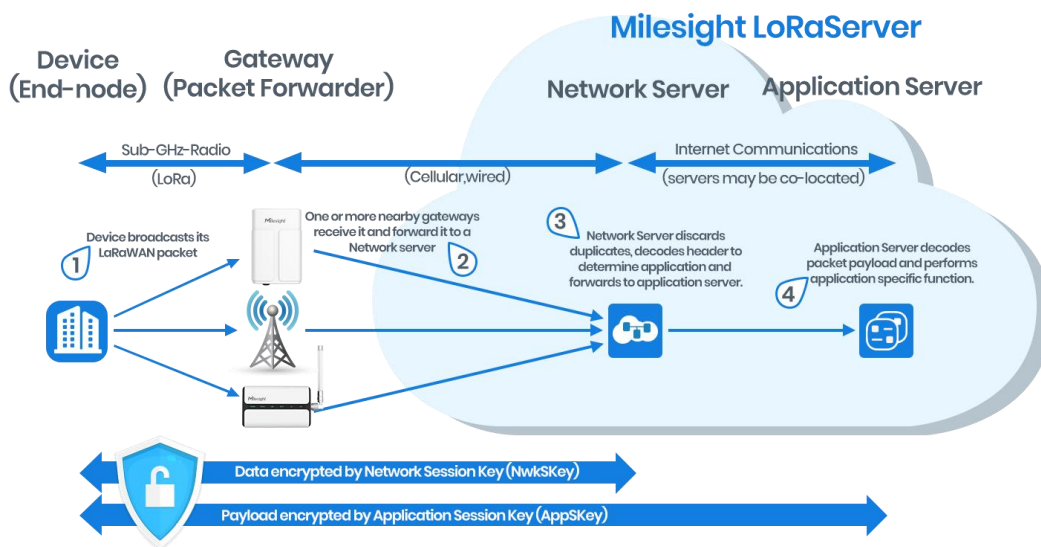

3.2.1 Packet Forwarder

3.2.1.1 General

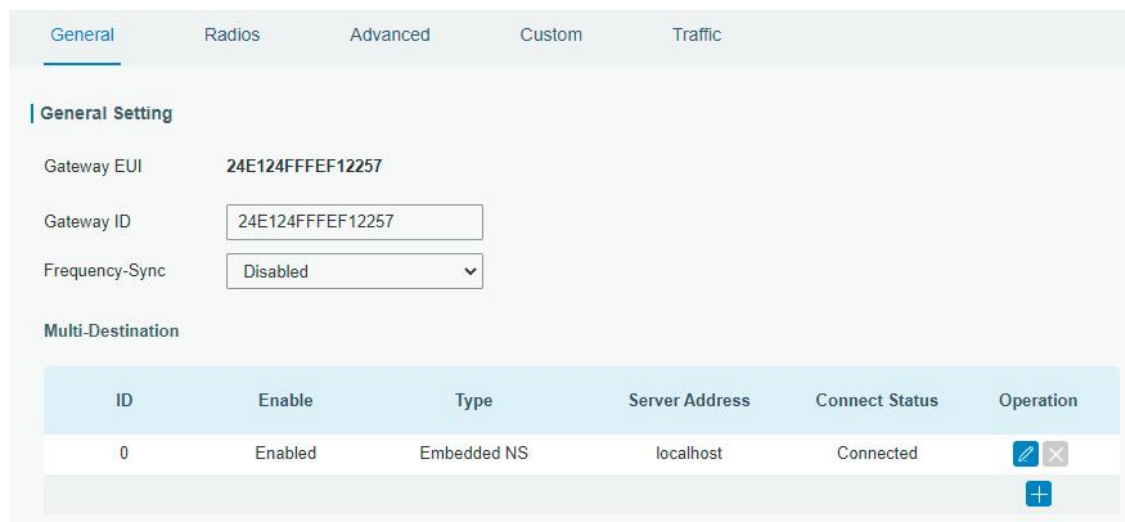

Figure 3-2-1-1

General Settings		
Item	Description	Default
Gateway EUI	Show the identifier of the gateway.	Generated from MAC address of the gateway and cannot

		be changed.
Gateway ID	Fill in the corresponding ID which you've used for register gateway on the remote network server, such as TTN. It is usually the same as gateway EUI and can be changed.	The same as gateway EUI.
Frequency-Sync	Sync frequency configurations from network server by selecting the corresponding ID.	Disabled
Multi-Destination	The gateway will forward the data to the network server address that was created and enabled in the list.	Local host
Connection Status	Show the connection status of package forwarder.	---

Table 3-2-1-1 General Setting Parameters

Related Configuration Example

[Packet forwarder configuration](#)

3.2.1.2 Radios

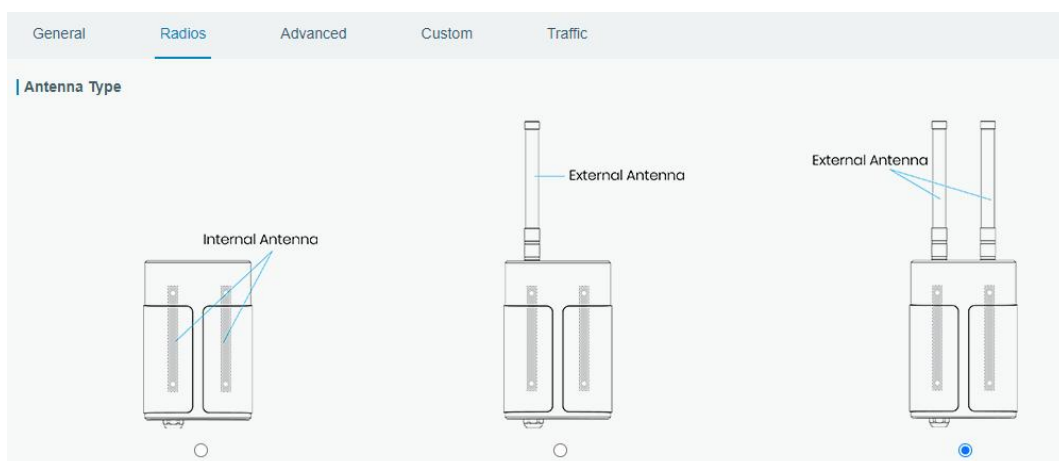

Figure 3-2-1-2

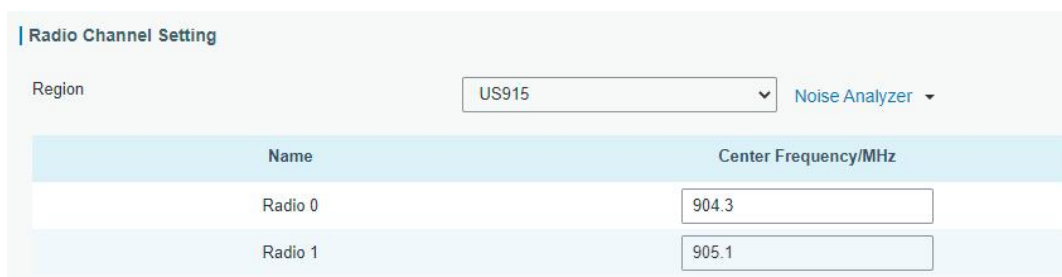

Figure 3-2-1-3

Radios-Radio Channel Setting		
Item	Description	Default
Antenna Type	Select the transmission type of antennas.	2 × External Antennas

Region	Choose the LoRaWAN® frequency plan used for the upstream and downlink frequencies and datarates. Available channel plans depend on the gateway's model.	Based on the gateway's model
Center Frequency	Change the frequencies to receive packets from LoRaWAN® nodes.	Based on what is specified in the LoRaWAN® regional parameters document

Table 3-2-1-2 Radio Channels Setting Parameters

Multi Channels Setting			
Enable	Index	Radio	Frequency/MHz
<input checked="" type="checkbox"/>	0	Radio 0	923.2
<input checked="" type="checkbox"/>	1	Radio 0	923.4
<input checked="" type="checkbox"/>	2	Radio 0	923.6
<input checked="" type="checkbox"/>	3	Radio 1	922.2
<input checked="" type="checkbox"/>	4	Radio 1	922.4
<input checked="" type="checkbox"/>	5	Radio 1	922.6
<input checked="" type="checkbox"/>	6	Radio 1	922.8
<input checked="" type="checkbox"/>	7	Radio 1	923.0

Figure 3-2-1-4

Radios-Multi Channel Setting		
Item	Description	Default
Enable	Click to enable this channel to transmit packets.	Enabled
Index	Indicate the ordinal of the list.	/
Radio	Choose Radio 0 or Radio 1 as center frequency.	Radio 0
Frequency/MHz	Enter the frequency of this channel. Range: center frequency \pm 0.4625.	Based on the LoRaWAN® regional document

Table 3-2-1-3 Multi Channel Setting Parameters

LoRa Channel Setting				
Enable	Radio	Frequency/MHz	Bandwidth/KHz	Spread Factor
<input checked="" type="checkbox"/>	Radio 0	923.8	250KHZ	SF7

Figure 3-2-1-5

Radios-LoRa Channel Setting		
Item	Description	Default
Enable	Click to enable this channel to transmit packets.	Enabled
Radio	Choose Radio 0 or Radio 1 as center frequency.	Radio 0
Frequency/MHz	Enter the frequency of this channel.	Based on the

	Range: center frequency \pm 0.9.	supported frequency
Bandwidth/MHz	Enter the bandwidth of this channel.	500KHz
Spread Factor	Choose the selectable spreading factor. The channel with large spreading factor corresponds to a low rate, while the small one corresponds to a high rate.	Based on what is specified in the LoRaWAN [®] regional parameters document

Table 3-2-1-4 LoRa Channel Setting Parameters

FSK Channel Setting

Enable	Radio	Frequency/MHz	Bandwidth/KHz	DataRate
<input checked="" type="checkbox"/>	Radio 0	924.0	125KHz	50000

Figure 3-2-1-6

Radios-FSK Channel Setting		
Item	Description	Default
Enable	Click to enable this channel to transmit packets.	Disabled
Radio	Choose Radio 0 or Radio 1 as center frequency.	Radio 0
Frequency/MHz	Enter the frequency of this channel. Range: center frequency \pm 0.9.	Based on the supported frequency
Bandwidth/MHz	Enter the bandwidth of this channel. Recommended value: 125KHz, 250KHz, 500KHz	Based on the supported frequency
Data Rate	Enter the data rate. Range: 500-25000.	500

Table 3-2-1-5 FSK Channel Setting Parameters

3.2.1.3 Noise Analyzer

Noise analyzer is used for scanning the noise of every frequency channel and giving a diagram for users to analyze the environment interference condition and select best deployment. RSSI indicates the sensitivity for every channel. **Lower the RSSI value, better the signal. It's not suggested to enable this feature when using package forwarder since it will affect the downlink transmission.**

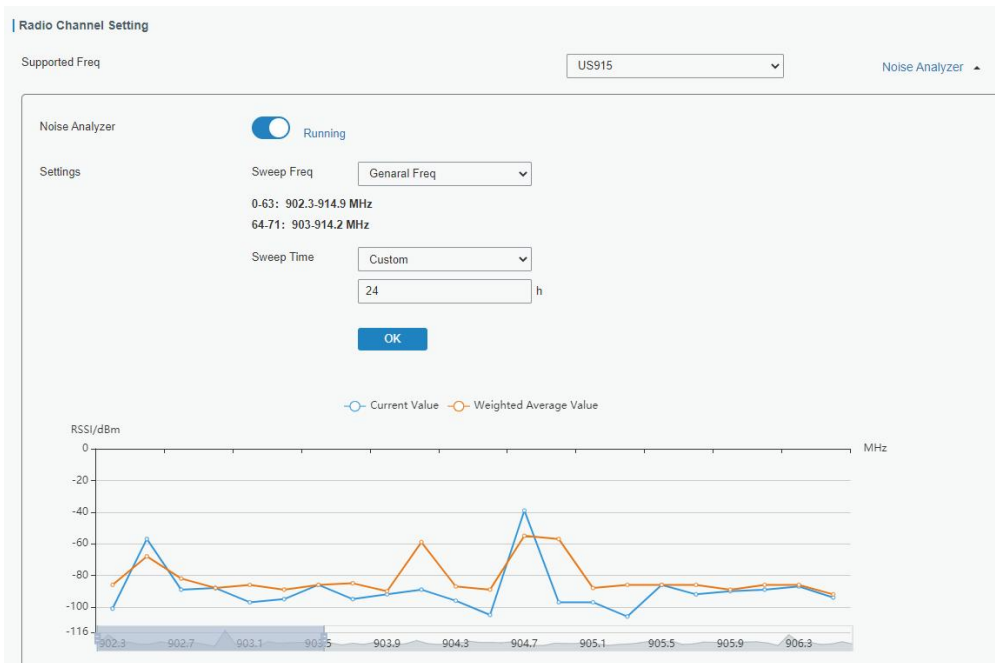

Figure 3-2-1-7

Noise Analyzer		
Item	Description	Default
Enable	Click to enable noise analyzer feature.	Disabled
Sweep Freq	Select the frequency sweeping range. General Freq: frequencies based on the LoRaWAN® regional parameters document Custom: custom the frequency range	General Freq
Sweep Time	Enable the noise analyzer continuously or within a period of time. If Custom is selected, the noise analyzer will stop automatically after the pre-configured time. Note: It's suggested to custom the time since noise analyzer feature will affect the normal data transmission.	Custom/24h

Table 3-2-1-6 Noise Analyzer Setting Parameters

3.2.1.4 Advanced

This section is about settings in details of beacon transmitting and validating.

General	Radios	Advanced	Custom	Traffic
Beacon Setting				
Beacon Period		<input type="text" value="0"/>	s	
Beacon Freq		<input type="text" value="508300000"/>	Hz	
Beacon Datarate		<input type="text" value="SF10"/>		
Beacon Channel Number		<input type="text" value="3"/>		
Beacon Freq Step		<input type="text" value="200000"/>	Hz	
Beacon Bandwidth		<input type="text" value="125000"/>	Hz	
Beacon TX Power		<input type="text" value="14"/>	dBm	

Figure 3-2-1-8

Advanced-Beacon Setting		
Item	Description	Default
Beacon Period	Interval of gateway sending beacons for Class B device time synchronization. 0 means the gateway will not send beacons.	0
Beacon Freq	The frequency of beacons.	Based on the supported frequency
Beacon Datarate	The datarate of beacons.	Based on the supported frequency
Beacon Channel Number	When selecting Custom, it allows users to custom range from 1 to 8.	1
Beacon Freq Step	Frequency interval of beacons.	200000
Beacon Bandwidth	The bandwidth of beacons. Unit: Hz	12500 Hz
Beacon TX Power	The TX power of beacons.	Based on the supported frequency

Table 3-2-1-7 Advanced-Beacon Parameters

Intervals Setting

Keep Alive Interval s

Stat Interval s

Push Timeout ms

Forward CRC Setting

Forward CRC Disabled

Forward CRC Error

Forward CRC Valid

Figure 3-2-1-9

Item	Description	Default
Keep Alive Interval	Enter the interval of keepalive packet which is sent from gateway to network server to keep the connection stable and alive. Range: 1-3600.	10
Stat Interval	Enter the interval to update the network server with gateway statistics. Range: 1-3600.	30
Push Timeout	Enter the timeout to wait for the response from server after the gateway sends data of node. Rang: 1-1999.	100
Forward CRC Disabled	Enable to send packets received with CRC disabled to the network server.	Disabled
Forward CRC Error	Enable to send packets received with CRC errors to the network server.	Disabled
Forward CRC Valid	Enable to send packets received with CRC valid to the network server.	Enabled

Table 3-2-1-8 Advanced Parameters

3.2.1.5 Custom

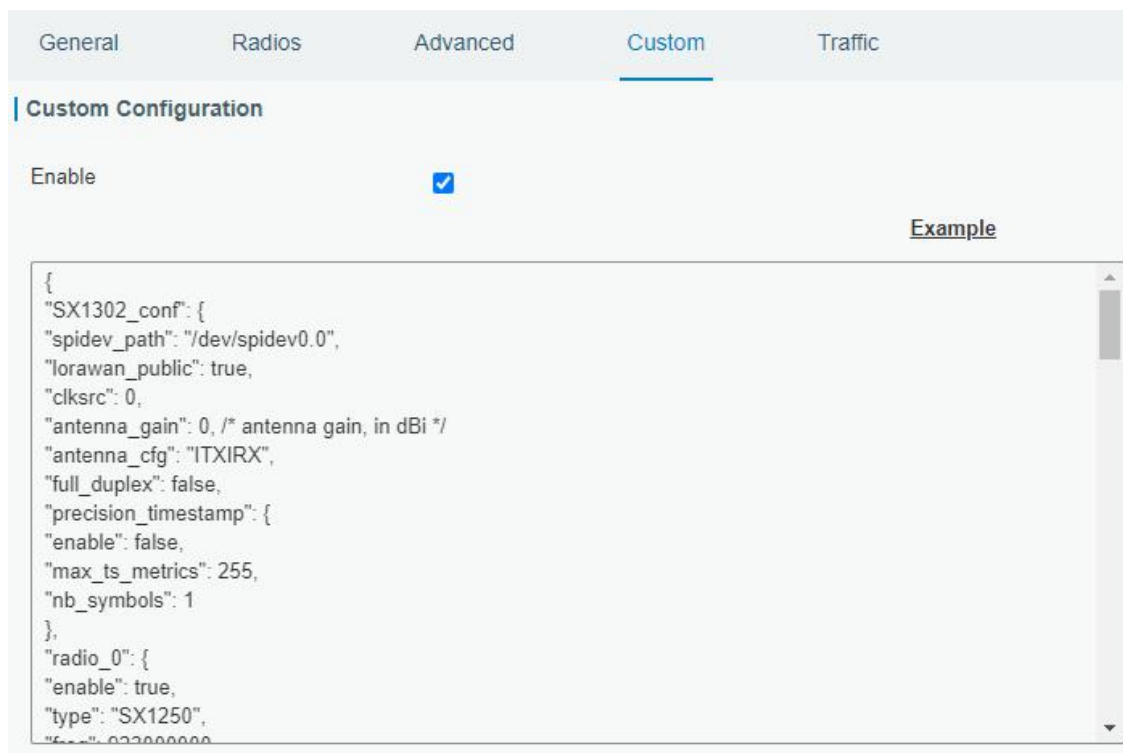

General Radios Advanced **Custom** Traffic

Custom Configuration

Enable

[Example](#)

```
{
  "SX1302_conf": {
    "spidev_path": "/dev/spidev0.0",
    "lorawan_public": true,
    "clksrc": 0,
    "antenna_gain": 0, /* antenna gain, in dBi */
    "antenna_cfg": "ITXIRX",
    "full_duplex": false,
    "precision_timestamp": {
      "enable": false,
      "max_ts_metrics": 255,
      "nb_symbols": 1
    },
  },
  "radio_0": {
    "enable": true,
    "type": "SX1250",
    "freq": 863000000
  }
}
```

Figure 3-2-1-10

When Custom Configuration mode is enabled, you can write your own packet forwarder configuration file in the edit box to configure packet forwarder. Click “Save” to save your custom configuration file content, and click “Apply” to take effect. You can click “Clear” to erase all content in the edit box. If you don’t know how to write configuration file, please click “Example” to go to reference page.

3.2.1.6 Traffic

When navigating to the traffic page, any recent traffic received by the gateway will display. To watch live traffic, click **Refresh**.

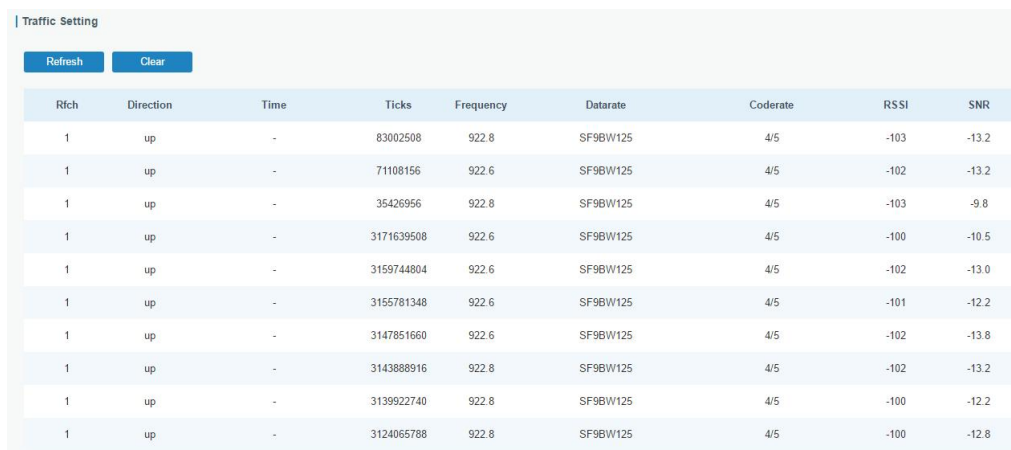

Rfch	Direction	Time	Ticks	Frequency	Datarate	Coderate	RSSI	SNR
1	up	-	83002508	922.8	SF9BW125	4/5	-103	-13.2
1	up	-	71108156	922.6	SF9BW125	4/5	-102	-13.2
1	up	-	35426956	922.8	SF9BW125	4/5	-103	-9.8
1	up	-	3171639508	922.6	SF9BW125	4/5	-100	-10.5
1	up	-	3159744804	922.6	SF9BW125	4/5	-102	-13.0
1	up	-	3155781348	922.6	SF9BW125	4/5	-101	-12.2
1	up	-	3147851660	922.6	SF9BW125	4/5	-102	-13.8
1	up	-	3143888916	922.8	SF9BW125	4/5	-102	-13.2
1	up	-	3139922740	922.8	SF9BW125	4/5	-100	-12.2
1	up	-	3124065788	922.8	SF9BW125	4/5	-100	-12.8

Figure 3-2-1-11

Item	Description
Refresh	Click to obtain the latest data.
Clear	Click to clear all data.
Rfch	Show the channel of this packet.
Direction	Show the direction of this packet.
Time	Show the receiving time of this packet.
Ticks	Show the ticks of this packet.
Frequency	Show the frequency of the channel.
Datarate	Show the datarate of the channel.
Coderate	Show the coderate of this packet.
RSSI	Show the received signal strength.
SNR	Show the signal to noise ratio of this packet.

Table 3-2-1-9 Traffic Parameters

3.2.2 Network Server

3.2.2.1 General

General
Applications
Profiles
Device

General Setting

Enable

Platform Mode

NetID

Join Delay sec

RX1 Delay sec

Lease Time hh-mm-ss

Log Level

Global Channel Plan Setting

Channel Plan

Channel

Figure 3-2-2-1

Item	Description	Default
General Setting		
Enable	Click to enable Network Server mode.	Enabled
Platform Mode	Enabled to connect gateway to Milesight IoT Cloud or Yeastar Workplace platform.	Disabled
NetID	Enter the network identifier.	010203
Join Delay	Enter the interval time between when the end-device sends a Join_request_message to network server and when the end-device prepares to open RX1 to receive the Join_accept_message sent from network server.	5
RX1 Delay	Enter the interval time between when the end-device sends uplink packets and when the end-device prepares to open RX1 to receive the downlink packet.	1
Lease Time	Enter the amount of time till a successful join expires. The format is hours-minutes-seconds. If the join-type is OTAA, then the end-devices need to join the network server again when it exceeds the lease time.	876000-00-00
Log level	Choose the log level.	Info
Channel Plan Setting		
Channel Plan	Choose LoRaWAN® channel plan used for the upstream and downlink frequencies and datarates. Available channel plans depend on the gateway's model.	Depend on the gateway's frequency
Channel	<p>Enabled frequencies are controlled using channel mask.</p> <p>Leave it blank means using all the default standard usable channels specified in the LoRaWAN® regional parameters document. It allows to enter the index of the cahnnels.</p> <p>Examples:</p> <p>1, 40: Enabling Channel 1 and Channel 40</p> <p>1-40: Enabling Channel 1 to Channel 40</p> <p>1-40, 60: Enabling Channel 1 to Channel 40 and Channel 60</p> <p>All: Enabling all channels</p> <p>Null: Indicates that all channels are disabled</p>	Depend on the gateway's frequency

Table 3-2-2-1 General Parameters

Note: For some regional variants, if allowed by your LoRaWAN® region, you can use Additional Plan to configure additional channels undefined by the LoRaWAN® Regional Parameters, like EU868 and KR920, as the following picture shows:



Figure 3-2-2-2

Additional Channels		
Item	Description	Default
Frequency/MHz	Enter the frequency of the additional plan.	Null.
Max Datarate	Enter the max datarate for the end-device. The range is based on what is specified in the LoRaWAN® regional parameters document.	DR0(SF12,125kHz)
Min Datarate	Enter the min datarate for the end-device. The range is based on what is specified in the LoRaWAN® regional parameters document.	DR3(SF9,125kHz)

Table 3-2-2-2 Additional Plan Parameters

3.2.2.2 Application

An application is a collection of devices with the same purpose/of the same type. All devices with the same "Payload Codec" and data transmission destination can be added under the same application.

You can edit the application by clicking  or create a new application by clicking .

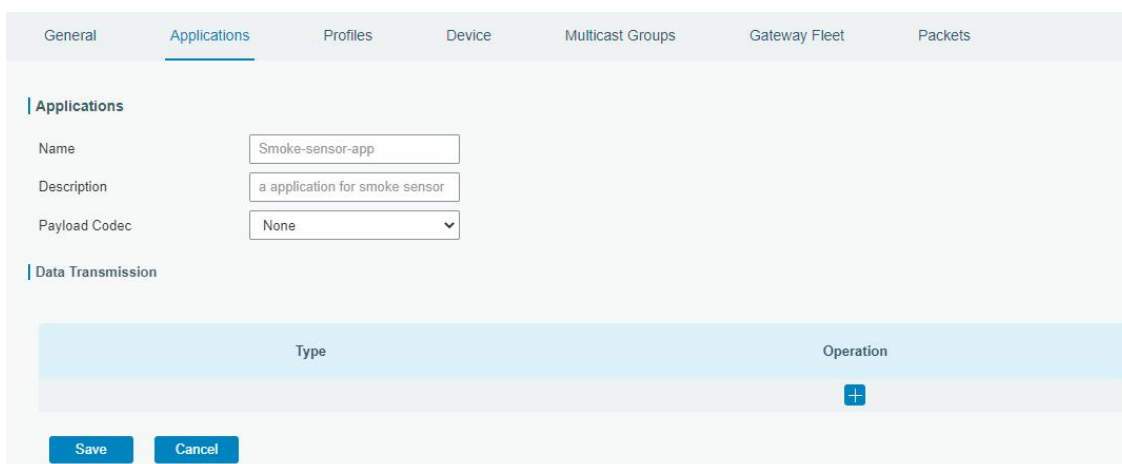

Figure 3-2-2-3

Item	Description
Name	Enter the name of the application profile. E.g Smoker-sensor-app.
Description	Enter the description of this application.

	E.g a application for smoker sensor.
Payload Codec	Select from: "None", "Cayenne LPP", "Custom". None: This mode enables devices not to encode data. Cayenne LPP: This mode enables devices to encode data with the Cayenne Low Power Payload (LPP). Custom: This mode enables devices to encode data with the decoder function and the encoder function which you have entered the code.
Data Transmission	Data will be sent to your custom server using the MQTT,HTTP or HTTPS protocol.

Table 3-2-2-3 Application Parameters

The screenshot displays the configuration page for an MQTT application. At the top, the 'Type' is set to 'MQTT' in a dropdown menu, and the 'Status' is shown as '-'. Below this, there are two sections: 'General' and 'User Credentials'. The 'General' section includes input fields for 'Broker Address', 'Broker Port', 'Client ID', 'Connection Timeout/s' (set to 30), and 'Keep Alive Interval/s' (set to 60). The 'User Credentials' section has an 'Enable' checkbox checked, and input fields for 'Username' and 'Password'.

Figure 3-2-2-4

TLS

Enable

Mode

Topic

Data Type	topic	
Uplink data	<input type="text"/>	QoS 0
Downlink data	<input type="text"/>	QoS 0
Multicast downlink data	<input type="text"/>	QoS 0
Join notification	<input type="text"/>	QoS 0
ACK notification	<input type="text"/>	QoS 0
Error notification	<input type="text"/>	QoS 0

Figure 3-2-2-5

MQTT Settings		
Item	Description	Default
General		
Broker Address	MQTT broker address to receive data.	--
Broker Port	MQTT broker port to receive data.	--
Client ID	Client ID is the unique identity of the client to the server. It must be unique when all clients are connected to the same server, and it is the key to handle message at QoS 1 and 2.	--
Connection Timeout/s	If the client does not get a response after the connection timeout, the connection will be considered as broken. The Range: 1-65535	30
Keep Alive Interval/s	After the client is connected with the server, the client will send heartbeat packet to the server regularly to keep alive. Range: 1-65535	60
User Credentials		
Enable	Enable user credentials.	
Username	The username used for connecting to MQTT broker.	
Password	The password used for connecting to MQTT broker.	
TLS		
Enable	Enable the TLS encryption in MQTT communication.	
Mode	Select from "Self signed certificates", "CA signed server certificate". CA signed server certificate: verify with the certificate issued by Certificate Authority (CA) that pre-loaded on device. Self signed certificates: upload the custom CA certificates, client certificates and secret key for verification.	

Topic	
Data Type	Data type sent to MQTT broker.
Topic	Topic name of the data type using for publish.
QoS	<p>QoS 0 – Only Once This is the fastest method and requires only 1 message. It is also the most unreliable transfer mode.</p> <p>QoS 1 – At Least Once This level guarantees that the message will be delivered at least once, but may be delivered more than once.</p> <p>QoS 2 – Exactly Once QoS 2 is the highest level of service in MQTT. This level guarantees that each message is received only once by the intended recipients. QoS 2 is the safest and slowest quality of service level.</p>

Table 3-2-2-4 MQTT Settings Parameters

HTTP Header

Header Name	Header Value	Operation
		+

URL

Data Type	URL
Uplink data	<input type="text"/>
Join notification	<input type="text"/>
ACK notification	<input type="text"/>
Error notification	<input type="text"/>

Figure 3-2-2-6

HTTP/HTTPS Settings	
Item	Description
HTTP Header	
Header Name	A core set of fields in HTTP header.
Header Value	Value of the HTTP header.
URL	
Data Type	Data type sent to HTTP/HTTPS server.
Topic	Topic name of the data type using for publish.
URL	HTTP/HTTPS server URL to receive data.

Table 3-2-2-5 HTTP/HTTPS Settings Parameters

Related Configuration Example

[Application configuration](#)

3.2.2.3 Profiles

A Profile defines the device capabilities and boot parameters that are needed by the Network Server for setting the LoRaWAN® radio access service. These information elements shall be provided by the end-device manufacturer.

You can edit the device profile by clicking  or create a new device profile by clicking



General	Applications	Profiles	Device	Multicast Groups	Gateway Fleet	Packets
Device Profiles						
Name	Max TXPower	Join Type	Class Type	Operation		
OTAA-ClassA-B	0	OTAA	Class A Class B			
OTAA-ClassC	0	OTAA	Class A Class C			
node	0	OTAA	Class A Class C			
						

Figure 3-2-2-7

Device Profiles

Name

Max TXPower

Join Type

Class Type Class A Class B Class C

Advanced

Figure 3-2-2-8

Device Profiles Settings		
Item	Description	Default
Name	Enter the name of the device profile. E.g. Smoker-sensor-app.	Null
Max TXPower	Enter the maximum transmit power. The TXPower indicates power levels relative to the Max EIRP level of the end-device. 0 means using the max EIRP. EIRP refers to the Equivalent Isotropically Radiated Power.	0
Join Type	Select from: "OTAA" and "ABP". OTAA:Over-the-Air Activation.	OTAA

	<p>For over-the-air activation, end-devices must follow a join procedure prior to participating in data exchanges with the network server. An end-device has to go through a new join procedure every time as it has lost the session context information.</p> <p>ABP: Activation by Personalization. Under certain circumstances, end-devices can be activated by personalization. Activation by personalization directly ties an end-device to a specific network bypassing the join request - join accept procedure.</p>	
Class Type	<p>Device type is Class A by default. Users can check the box of Class B or Class C to add the class type.</p> <p>Note: Beacon period should be set to nonzero value in Packet Forwarder->Advanced if you use Class B.</p>	---

Table 3-2-2-6 Device Profiles Setting Parameters

Figure 3-2-2-9

Device Profile Advanced Settings		
Item	Description	Default
MAC Version	Choose the version of the LoRaWAN® supported by the end-device.	1.0.2
Regional Parameter Revision	Revision of the Regional Parameters document supported by the end-device.	B
RX1 Datarate Offset	The offset which used for calculating the RX1 data-rate, based on the uplink data-rate.	Based on what is specified in the LoRaWAN® regional
RX2 Datarate	Enter the RX2 datarate which used for the RX2 receive-window.	

RX2 Channel Frequency	RX2 channel frequency which used for the RX2 receive-window.	parameters document
Frequency List	List of factory-preset frequencies. The range is based on what is specified in the LoRaWAN® regional parameters document.	Null
Device Channel	Change this device frequency channel by typing the channel indexes. When configured, it takes precedence over the global channel. This setting only works for CN470/US915/AU915 gateway.	Null
PingSlot Period	Period of opening the pingslot.	Every Second
PingSlot DataRate	Datarate of the node receiving downlinks.	Based on the supported frequency
PingSlot Freq	Frequency of the node receiving downlinks.	Based on the supported frequency
ACK Timeout	The time for confirmed downlink transmissions. This option is only applicable to class B and class C.	Class B: 10 Class C: 10

Table 3-2-2-7 Device Profiles Advanced Setting Parameters

3.2.2.4 Device

A device is the end-device connecting to, and communicating over the LoRaWAN® network.

Device Name	Device EUI	Device-Profile	Application	Last Seen	Activated	Operation
24E124414B032563	24E124414B032563	classB	cloud	11 days ago	✓	✎ ✕
24E124414A501971	24E124414A501971	OTAA-calsB	cloud	28 days ago	✓	✎ ✕
1152-test	24E1612290821375	ClassC-OTAA	cloud	63 days ago	✓	✎ ✕

Figure 3-2-2-10

Item	Description
Add	Add a device.
Bulk Import	Download template and import multiple devices.
Delete All	Delete all devices in the list.
Device Name	Show the name of the device.
Device EUI	Show the EUI of the device.
Device-Profile	Show the name of the device's device profile.
Application	Show the name of the device's application.
Last Seen	Show the time of last packet received.

Activated	Show the status of the device .  means that the device has been activated.
Operation	Edit or delete the device.

Table 3-2-2-8 Device Parameters

Device Name	<input type="text" value="lora-sensor"/>
Description	<input type="text" value="a short description of your node"/>
Device EUI	<input type="text" value="24e1641194784358"/>
Device-Profile	<input type="text" value="OTAA"/> ▼
Application	<input type="text" value="app"/> ▼
Modbus RTU Data Transmission	<input type="text" value="Modbus RTU to TCP"/> ▼
Fport	<input type="text"/>
TCP Port	<input type="text"/>
Frame-counter Validation	<input type="checkbox"/>
Application Key	<input type="text"/>
Device Address	<input type="text"/>
Network Session Key	<input type="text"/>
Application Session Key	<input type="text"/>
Uplink Frame-counter	<input type="text" value="0"/>
Downlink Frame-counter	<input type="text" value="0"/>

Figure 3-2-2-11

Device Configuration		
Item	Description	Default
Device Name	Enter the name of this device.	Null
Description	Enter the description of this device.	Null
Device EUI	Enter the EUI of this device.	Null
Device-Profile	Choose the device profile.	Null
Application	Choose the application profile.	Null
Modbus RTU Data Transmission	Choose from: "Disable", "Modbus RTU to TCP", "Modbus RTU over TCP". This feature is only applicable to Milesight class C type LoRaWAN® controllers.(UC501/UC300, etc.)	Disable

	<p>-Modbus RTU to TCP: TCP client can send Modbus TCP commands to ask for controller Modbus data.</p> <p>-Modbus RTU over TCP: TCP client can send Modbus RTU commands to ask for controller Modbus data.</p>	
Fport	<p>Enter the LoRaWAN® frame port for transparent transmission between Milesight LoRaWAN® controllers and UG67.</p> <p>Range: 2-84, 86-223.</p> <p>Note: this value must be the same as the Milesight LoRaWAN® controller's Fport.</p>	Null
TCP Port	<p>Enter the TCP port for data transmission between the TCP Client and UG67 (as TCP Server).</p> <p>Range: 1-65535.</p>	Null
Frame-Counter Validation	<p>If disable the frame-counter validation, it will compromise security as it enables people to perform replay-attacks.</p>	Enabled
Application Key	<p>Whenever an end-device joins a network via over-the-air activation, the application key is used for derive the Application Session key.</p>	Null
Device Address	<p>The device address identifies the end-device within the current network.</p>	Null
Network Session Key	<p>The network session key specific for the end-device. It is used by the end-device to calculate the MIC or part of the MIC (message integrity code) of all uplink data messages to ensure data integrity.</p>	Null
Application Session Key	<p>The AppSKey is an application session key specific for the end-device. It is used by both the application server and the end-device to encrypt and decrypt the payload field of application-specific data messages.</p>	Null
Uplink Frame-counter	<p>The number of data frames which sent uplink to the network server. It will be incremented by the end-device and received by the end-device. Users can reset the a personalized end-device manually, then the frame counters on the end-device and the frame counters on the network server for that end-device will be reset to 0.</p>	Null
Downlink Frame-counter	<p>The number of data frames which received by the end-device downlink from the network server. It will be incremented by the network server. Users can reset the a personalized end-device manually, then the frame counters on the end-device and the frame counters on the network server for that end-device will be reset to 0.</p>	Null

Table 3-2-2-9 Device Setting Parameters

Related Configuration Example

[Device configuration](#)

3.2.2.5 Multicast Groups

Milesight gateways support for creating Class B or Class C multicast groups to send downlink messages to a group of end devices. A multicast group is a virtual ABP device (i.e. shared session keys), does not support uplink, confirmed downlink nor MAC commands.

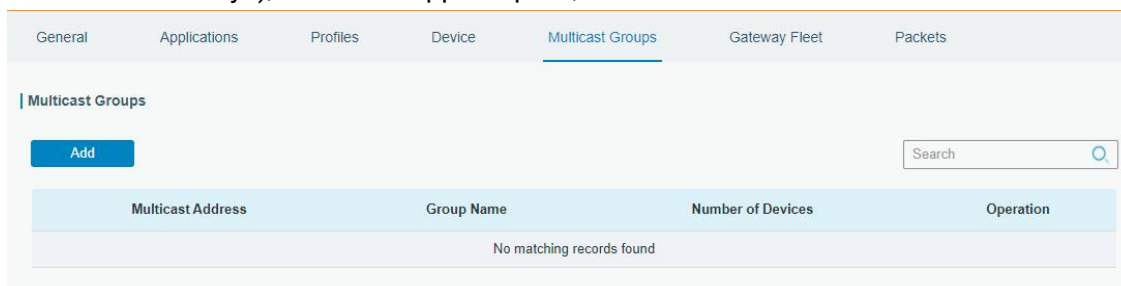

Figure 3-2-2-12

Item	Description
Add	Add a multicast group.
Group Name	Show the name of the group.
Number of Devices	Show the device number of the group.
Operation	Edit or delete the multicast group.

Table 3-2-2-10 Multicast Group Parameters

Group Name	<input type="text"/>
Multicast Address	<input type="text"/>
Multicast Network Session Key	<input type="text"/>
Multicast Application Session Key	<input type="text"/>
Class Type	Class C <input type="button" value="v"/>
Datarate	DR8(SF12,500KHz) <input type="button" value="v"/>
Frequency	923300000 <input type="text"/> Hz
Frame-counter	0 <input type="text"/>
Selected Devices	
<input type="text"/>	
Add Device	
<input type="text"/>	

Figure 3-2-2-13

Multicast Group Configuration		
Item	Description	Default
Group Name	Enter the name of this multicast group.	Null
Multicast Address	Device address (Dev Addr) of all devices in this group.	Null
Multicast Network Session Key	The network session key (Netwks Key) of all devices in this group.	Null
Multicast Application Session Key	The application session key(AppSKey) of all devices in this group.	Null
Class Type	Class B and Class C are optional.	Class C
Datarate	Datarate of the node receiving downlinks	Based on the supported frequency
Frequency	Downlink frequency of all devices in this group.	Based on the supported frequency
Frame-counter	The number of data frames which received by the end-device downlink from the network server. It will be incremented by the network server.	0
Ping Slot Periodicity	Period of opening the pingslot. This is only applied to Class B end devices.	Every 4 second
Selected Devices	Show all device names in this group.	Null
Add Device	Add devices in the pull-down list.	Null

Table 3-2-2-11 Multicast Group Setting Parameters

3.2.2.6 Gateway Fleet

Milesight gateways can connect to UG67 network server. At most 4 gateways can be added to one gateway.

General	Applications	Profiles	Device	Multicast Groups	Gateway Fleet	Packets
Gateway Fleet						
Gateway ID	Name	Status	Last Seen	Operation		
24E124FFFEF12263	Local Gateway	Connected	2021-04-19 16:12:27	✎ ✕		
						+

Figure 3-2-2-14

Item	Description
Gateway ID	Show the gateway ID.
Name	Show the name of the gateway.

Status	Show the connection status of the gateway.
Last Seen	Show the time of last packet received.
Operation	Edit or delete the gateway.

Table 3-2-2-12 Gateway Fleet Parameters

Figure 3-2-2-15

Item	Description
Gateway ID	Enter the unique gateway ID to recognize the gateway.
Name	Enter the name of this gateway.
Location	GPS data of the gateway can be edited here. If gateway sends GPS data it will replace your customized data.

Table 3-2-2-13 Gateway Setting Parameters

3.2.2.7 Packets

Figure 3-2-2-16

Send Data To Device/Multicast Group		
Item	Description	Default
Device EUI	Enter the EUI of the device to receive the payload.	Null
Multicast Group	Select the multicast group to send downlinks. Multicast groups can be added under Multicast Groups tab.	Null
Type	Choose from: "ASCII", "hex", "base64". Choose the payload type to enter in the payload Input box.	ASCII
Payload	Enter the message to be sent to this device.	Null
Port	Enter the LoRaWAN® frame port for packet transmission between device and Network Server.	Null
Confirmed	After enabled, the end device will receive downlink packet and should answer "confirmed" to the network server. Multicast feature does not support confirmed downlink.	Disabled

Table 3-2-2-14 Send Data to Device Parameters

Network Server	
Item	Description
Device EUI/Group	Show the EUI of the device or multicast group.
Frequency	Show the used frequency to transmit packets.
Datarate	Show the used datarate to transmit packets.
SNR	Show the signal-noise ratio.
RSSI	Show the received signal strength indicator.
Size	Show the size of payload.
Fcnt	Show the frame counter.
Type	Show the type of the packet: JnAcc - Join Accept Packet JnReq - Join Request Packet UpUnc - Uplink Unconfirmed Packet UpCnf - Uplink Confirmed Packet - ACK response from network requested DnUnc - Downlink Unconfirmed Packet DnCnf - Downlink Confirmed Packet- ACK response from end-device requested
Time	Show the time of packet was sent or received.

Table 3-2-2-15 Packet Parameters

Click  to get more details about the packet. As shown:

Packet Details	
Dev Addr/Multicast Addr	0614B991
GwEUI	24E124FFFEF0E225
AppEUI	24E124C0002A0001
Device EUI/Group Name	24E124126A210644
Class Type	Class C
Immediately	-
Timestamp	2721022973
Type	UpUnc
Adr	false
AdrAckReq	false
Ack	false
Fcnt	969
Port	85

Figure 3-2-2-17

Item	Description
Dev Addr/Multicast Addr	Show the address of the device/multicast group.
GwEUI	Show the EUI of the gateway.
AppEUI	Show the EUI of the application.
DevEUI/Group Name	Show the EUI of the device/multicast group name.
Class Type	Show the class type of the device or multicast group.
Immediately	True: Device may transmit an explicit (possibly empty) acknowledgement data message immediately after the reception of a data message requiring a confirmation.
Timestamp	Show the timestamp of this packet.
Type	Show the type of the packet: JnAcc - Join Accept Packet JnReq - Join Request Packet UpUnc - Uplink Unconfirmed Packet UpCnf - Uplink Confirmed Packet - ACK response from network requested DnUnc - Downlink Unconfirmed Packet DnCnf - Downlink Confirmed Packet- ACK response from end-device requested
Adr	True: The end-node has enabled ADR. False: The end-node has not enabled ADR.
AdrAckReq	In order to validate that the network is receiving the uplink messages, nodes periodically transmit ADRACKReq message. This is 1 bit long. True: Network should respond in ADR_ACK_DELAY time to confirm that it is receiving the uplink messages.

	False: ADR is disabled or Network does not respond in ADR_ACK_DELAY.
Ack	True: This frame is ACK. False: This frame is not ACK.
Fcnt	Show the frame-counter of this packet. The network server tracks the uplink frame counter and generates the downlink counter for each end-device.
FPort	FPort is a multiplexing port field. If the frame payload field is not empty, the port field must be present. If present, a FPort 16 value of 0 indicates that the FRMPayload contains MAC commands only. When this is the case, the FOptsLen field must be zero. FOptsLen is the length of the FOpts field in bytes.
Modulation	LoRa means the physical layer uses the LoRa modulation.
Bandwidth	Show the bandwidth of this channel.
SpreadFactor	Show the spreadFactor of this channel.
Bitrate	Show the bitrate of this channel.
CodeRate	Show the coderate of this channel.
SNR	Show the SNR of this channel.
RSSI	Show the RSSI of this channel.
Power	Show the transmit power of the device.
Payload (b64)	Show the application payload of this packet.
Payload (hex)	Show the application payload of this packet.
MIC	Show the MIC of this packet. MIC is a cryptographic message integrity code, computed over the fields MHDR, FHDR, FPort and the encrypted FRMPayload.

Table 3-2-2-16 Packets Details Parameters

Related Topic

[Send Data to Device](#)

3.3 Network

3.3.1 Interface

3.3.1.1 Port

The Ethernet port can be connected with Ethernet cable to get Internet access. It supports 3 connection types.

- **Static IP:** configure IP address, netmask and gateway for Ethernet WAN interface.
- **DHCP Client:** configure Ethernet WAN interface as DHCP Client to obtain IP address automatically.
- **PPPoE:** configure Ethernet WAN interface as PPPoE Client.

The screenshot shows the configuration page for 'Port_1' under the 'Port' tab. The left sidebar contains navigation options: Status, Packet Forwarder, Network Server, Network (expanded), Interface (selected), Firewall, DHCP, DDNS, and Link Failover. The main configuration area includes the following fields:

- Port: eth 0
- Connection Type: Static IP
- IP Address: 192.168.22.112
- Netmask: 255.255.255.0
- Gateway: 192.168.22.1
- MTU: 1500
- Primary DNS Server: 8.8.8.8
- Secondary DNS Server: 114.114.114.114
- Enable NAT:

Figure 3-3-1-1

Port Setting		
Item	Description	Default
Port	The port that is fixed as eth0 port and enabled.	eth 0
Connection Type	Select from "Static IP", "DHCP Client" and "PPPoE".	Static IP
MTU	Set the maximum transmission unit.	1500
Primary DNS Server	Set the primary DNS.	8.8.8.8
Secondary DNS Server	Set the secondary DNS.	114.114.114.114
Enable NAT	Enable or disable NAT function. When enabled, a private IP can be translated to a public IP.	Enable

Table 3-3-1-1 Port Parameters

Related Configuration Example

[Ethernet Connection](#)

1. Static IP Configuration

If the external network assigns a fixed IP for the Ethernet port, user can select "Static IP" mode.

The screenshot shows the configuration page for 'Port_1'. The 'Connection Type' is set to 'Static IP'. The IP Address is 192.168.22.112, Netmask is 255.255.255.0, Gateway is 192.168.22.1, MTU is 1500, Primary DNS Server is 8.8.8.8, and Secondary DNS Server is 114.114.114.114. 'Enable NAT' is checked. There is a table for 'Multiple IP Address' with columns for IP Address, Netmask, and Operation, and a '+' button to add more addresses.

Figure 3-3-1-2

Static IP		
Item	Description	Default
IP Address	Set the IP address which can access Internet.	192.168.23.150
Netmask	Set the Netmask for Ethernet port.	255.255.255.0
Gateway	Set the gateway's IP address for Ethernet port.	192.168.23.1
Multiple IP Address	Set the multiple IP addresses for Ethernet port.	Null

Table 3-3-1-2 Static IP Parameters

2. DHCP Client

If the external network has DHCP server enabled and has assigned IP addresses to the Ethernet WAN interface, user can select "DHCP client" mode to obtain IP address automatically.

The screenshot shows the configuration page for 'Port_1' with 'Connection Type' set to 'DHCP Client'. The MTU is 1500, 'Use Peer DNS' is unchecked, Primary DNS Server is 8.8.8.8, Secondary DNS Server is 114.114.114.114, and 'Enable NAT' is checked.

Figure 3-3-1-3

DHCP Client	
Item	Description
Use Peer DNS	Obtain peer DNS automatically during PPP dialing. DNS is necessary when user visits domain name.

Table 3-3-1-3 DHCP Client Parameters

3. PPPoE

PPPoE refers to a point to point protocol over Ethernet. User has to install a PPPoE client on the basis of original connection way. With PPPoE, remote access devices can get control of each user.

Figure 3-3-1-4

PPPoE	
Item	Description
Username	Enter the username provided by your Internet Service Provider (ISP).
Password	Enter the password provided by your Internet Service Provider (ISP).
Link Detection Interval (s)	Set the heartbeat interval for link detection. Range: 1-600.
Max Retries	Set the maximum retry times after it fails to dial up. Range: 0-9.
Use Peer DNS	Obtain peer DNS automatically during PPP dialing. DNS is necessary when user visits domain name.

Table 3-3-1-4 PPPOE Parameters

3.3.1.2 WLAN

This section explains how to set the related parameters for Wi-Fi network. UG67 supports 802.11 b/g/n, as AP or client mode.

Port	WLAN	Cellular	Loopback
WLAN			
Enable	<input checked="" type="checkbox"/>		
Work Mode	AP		
SSID Broadcast	<input checked="" type="checkbox"/>		
AP Isolation	<input type="checkbox"/>		
Radio Type	802.11n(2.4GHz)		
Channel	Auto		
SSID			
BSSID			
Encryption Mode	No Encryption		
Bandwidth	20MHz		
Max Client Number	10		
IP Setting			
Protocol	Static IP		
IP Address			
	DHCP Settings		
Netmask			

Figure 3-3-1-5

WLAN	
Enable	<input checked="" type="checkbox"/>
Work Mode	Client <input type="button" value="Scan"/>
SSID	
BSSID	
Encryption Mode	WPA-PSK/WPA2-PSK
Cipher	Auto
Key	
IP Setting	
Protocol	Static IP
IP Address	
Netmask	255.255.255.0
Gateway	

Figure 3-3-1-6

WLAN Settings	
Item	Description
Enable	Enable/disable WLAN.

Work Mode	Select gateway's work mode. The options are "Client" or "AP".
BSSID	Fill in the MAC address of the access point. Either SSID or BSSID can be filled to joint the network.
SSID	Fill in the SSID of the access point.
Client Mode	
Scan	Click "Scan" button to search the nearby access point.
Encryption Mode	Select encryption mode. The options are "No Encryption", "WEP Open System", "WEP Shared Key", "WPA-PSK", "WPA2-PSK", "WPA-PSK/WPA2-PSK", "WPA-Enterprise", "WPA2-Enterprise" and "WPA-Enterprise/WPA2-Enterprise".
Cipher	Select cipher. The options are "Auto", "AES", "TKIP" and "AES/TKIP".
Key	Fill the pre-shared key of WEP/WPA encryption.
XSupplicant Type	Select from "Peap", "Leap", "TLS" and "TTLS".
User	Fill the user of WPA/WPA2-Enterprise.
Anonymous Identity	Fill the anonymous identity of WPA/WPA2-Enterprise.
Phase2	Fill the phase2 of WPA/WPA2-Enterprise.
Public Server Certificate	The public server certificate used for verifying with WPA/WPA2-Enterprise access point.
AP Mode	
SSID Broadcast	When SSID broadcast is disabled, other wireless devices can't not find the SSID, and users have to enter the SSID manually to access to the wireless network.
AP Isolation	When AP isolation is enabled, all users which access to the AP are isolated without communication with each other.
Radio Type	Select Radio type. The options are "802.11b (2.4 GHz)", "802.11g (2.4 GHz)", "802.11n (2.4 GHz)".
Channel	Select wireless channel. The options are "Auto", "1", "2"....."11".
Encryption Mode	Select encryption mode. The options are "No Encryption", "WEP Open System", "WEP Shared Key", "WPA-PSK", "WPA2-PSK" and "WPA-PSK/WPA2-PSK".
Cipher	Select cipher. The options are "Auto", "AES", "TKIP" and "AES/TKIP".
Key	Fill the pre-shared key of WPA encryption.
Bandwidth	Select bandwidth. The options are "20MHz" and "40MHz".
Max Client Number	Set the maximum number of client to access when the gateway is configured as AP.
IP Setting	
Protocol	Set the protocol in wireless network.
IP Address	Set the IP address in wireless network.
Netmask	Set the netmask in wireless network.
Gateway	Set the gateway in wireless network.

Table 3-3-1-5 WLAN Parameters

Port	WLAN	Cellular	Loopback				
< GoBack							
SSID	Channel	Signal	Cipher	BSSID	Security	Frequency	
Vison Sensor_006602	Auto	-94dBm	Auto	24:e1:24:00:66:02	No Encryption	2462MHz	Join Network
Milesight_Test	Auto	-88dBm	AES	ec:26:ca:99:3a:a4	WPA-PSK/WPA2-PSK	2437MHz	Join Network

Figure 3-3-1-7

Client Mode-Scan	
SSID	Show SSID.
Channel	Show wireless channel.
Signal	Show wireless signal.
BSSID	Show the MAC address of the access point.
Security	Show the encryption mode.
Frequency	Show the frequency of radio.
Join Network	Click the button to join the wireless network.

Table 3-3-1-6 WLAN Scan Parameters

Related Topic

[Wi-Fi Application Example](#)

3.3.1.3 Cellular

This section explains how to set the related parameters for cellular network.

Port	WLAN	Cellular	Loopback
Cellular Setting			
Enable		<input checked="" type="checkbox"/>	
Network Type		Auto	
APN			
Username			
Password			
Access Number			
PIN Code			
Authentication Type		Auto	
Roaming		<input checked="" type="checkbox"/>	
SMS Center			

Figure 3-3-1-8

Connection Setting	<input type="checkbox"/>
Enable NAT	<input checked="" type="checkbox"/>
Restart When Dial-up failed	<input type="checkbox"/>
ICMP Server	<input type="text" value="8.8.8.8"/>
Secondary ICMP Server	<input type="text" value="114.114.114.114"/>
ICMP Detection Max Retries	<input type="text" value="3"/>
ICMP Detection Timeout	<input type="text" value="5"/> s
ICMP Detection Interval	<input type="text" value="15"/> s
SMS Settings	
SMS Mode	<input type="text" value="PDU"/>

Figure 3-3-1-9

General Settings		
Item	Description	Default
Enable	Check the option to enable the corresponding SIM card.	Enable
Network Type	Select from "Auto", "Auto 3G/4G", "4G Only" and "3G Only". Auto: connect to the network with the strongest signal automatically. 4G Only: connect to 4G network only. And so on.	Auto
APN	Enter the Access Point Name for cellular dial-up connection provided by local ISP.	Null
Username	Enter the username for cellular dial-up connection provided by local ISP.	Null
Password	Enter the password for cellular dial-up connection provided by local ISP.	Null
Access Number	Enter the dial-up center NO. For cellular dial-up connection provided by local ISP.	Null
PIN Code	Enter a 4-8 characters PIN code to unlock the SIM.	Null
Authentication Type	Select from "Auto", "PAP", "CHAP", "MS-CHAP", and "MS-CHAPv2".	Auto
Roaming	Enable or disable roaming.	Disable
SMS Center	Enter the local SMS center number for storing, forwarding, converting and delivering SMS message.	Null
Enable NAT	Enable or disable NAT function.	Enable
Restart When Dial-up failed	When this function is enabled, the gateway will restart automatically if the dial-up fails several times.	Disabled
ICMP Server	Set the ICMP detection server's IP address.	8.8.8.8

Secondary ICMP Server	Set the secondary ICMP detection server's IP address.	114.114.114.114
ICMP Detection Max Retries	Set max number of retries when ICMP detection fails.	3
ICMP Detection Timeout	Set timeout of ICMP detection.	5
ICMP Detection Interval	Set interval of ICMP detection.	15
SMS Mode	Select SMS mode from "TEXT" and "PDU".	PDU

Table 3-3-1-7 Cellular Parameters

Connection Setting

Connection Mode

Redial Interval(s)

Max Idle Time(s)

Triggered by Call

Triggered by SMS

Figure 3-3-1-10

Item	Description
Connection Mode	
Connection Mode	Select from "Always Online" and "Connect on Demand".
Redial Interval(s)	Set the time interval between redials. Range: 0-3600.
Max Idle Time(s)	Set the maximum duration of the gateway when current link is under idle status. Range: 10-3600.
Triggered by Call	The gateway will switch from offline mode to cellular network mode automatically when it receives a call from the specific phone number.
Call Group	Select a call group for call trigger. Go to "System > General Settings > Phone" to set up phone group.
Triggered by SMS	The gateway will switch from offline mode to cellular network mode automatically when it receives a specific SMS from the specific mobile phone.
SMS Group	Select a SMS group for trigger. Go to "System > General Settings > Phone" to set up SMS group.
SMS Text	Fill in the SMS content for triggering.

Table 3-3-1-8 Cellular Parameters

Related Topics

[Cellular Connection Application Example](#)

[Phone Group](#)

3.3.1.4 Loopback

Loopback interface is used for replacing gateway's ID as long as it is activated. When the interface is DOWN, the ID of the gateway has to be selected again which leads to long convergence time of OSPF. Therefore, Loopback interface is generally recommended as the ID of the gateway.

Loopback interface is a logic and virtual interface on gateway. Under default conditions, there's no loopback interface on gateway, but it can be created as required.

Figure 3-3-1-11

Loopback		
Item	Description	Default
IP Address	Unalterable	127.0.0.1
Netmask	Unalterable	255.0.0.0
Multiple IP Addresses	Apart from the IP above, user can configure other IP addresses.	Null

Table 3-3-1-9 Loopback Parameters

3.3.1.5 VLAN Trunk

UG67 gateway supports the Ethernet port working as VLAN Trunk client and be assigned a VLAN ID, which easy to traffic classification. When VLAN ID is set, port on **"Network" > "Interface" > "Port"** can be chosen as eth0.x with x being VLAN ID. VLAN Setting is blank

by default, you can add a new VLAN label to certain interface by clicking .

Figure 3-3-1-12

VLAN Trunk	
Item	Description

Interface	Select the VLAN interface, it's fixed as eth0.
VID	Set the label ID of the VLAN. Range: 1-4094.

Table 3-3-1-10 VLAN Trunk Parameters

3.3.2 Firewall

This section describes how to set the firewall parameters, including website block, ACL, DMZ, Port Mapping and MAC Binding.

The firewall implements corresponding control of data flow at entry direction (from Internet to local area network) and exit direction (from local area network to Internet) according to the content features of packets, such as protocol style, source/destination IP address, etc. It ensures that the gateway operate in a safe environment and host in local area network.

3.3.2.1 Security

The screenshot shows a configuration interface with tabs for Security, ACL, DMZ, Port Mapping, and MAC Binding. The Security tab is active. Under 'Website Blocking by URL Address', there is a text input field containing 'http://' with a blue 'X' delete button and a blue '+' add button. Below it, under 'Website Blocking by Keyword', there is an empty text input field with a blue 'X' delete button and a blue '+' add button.

Figure 3-3-2-1

Website Blocking	
URL Address	Enter the HTTP address which you want to block.
Keyword	You can block specific website by entering keyword. The maximum number of character allowed is 64.

Table 3-2-2-1 Security Parameters

3.3.2.2 ACL

Access control list, also called ACL, implements permission or prohibition of access for specified network traffic (such as the source IP address) by configuring a series of matching rules so as to filter the network interface traffic. When gateway receives packet, the field will be analyzed according to the ACL rule applied to the current interface. After the special packet is identified, the permission or prohibition of corresponding packet will be implemented according to preset strategy.

The data package matching rules defined by ACL can also be used by other functions requiring flow distinction.

Figure 3-3-2-2

Item	Description
ACL Setting	
Default Filter Policy	Select from "Accept" and "Deny". The packets which are not included in the access control list will be processed by the default filter policy.
Access Control List	
Type	Select type from "Extended" and "Standard".
ID	User-defined ACL number. Range: 1-199.
Action	Select from "Permit" and "Deny".
Protocol	Select protocol from "ip", "icmp", "tcp", "udp", and "1-255".
Source IP	Source network address (leaving it blank means all).
Source Wildcard Mask	Wildcard mask of the source network address.
Destination IP	Destination network address (0.0.0.0 means all).
Destination Wildcard Mask	Wildcard mask of destination address.
Description	Fill in a description for the groups with the same ID.
ICMP Type	Enter the type of ICMP packet. Range: 0-255.
ICMP Code	Enter the code of ICMP packet. Range: 0-255.
Source Port Type	Select source port type, such as specified port, port range, etc.
Source Port	Set source port number. Range: 1-65535.

Start Source Port	Set start source port number. Range: 1-65535.
End Source Port	Set end source port number. Range: 1-65535.
Destination Port Type	Select destination port type, such as specified port, port range, etc.
Destination Port	Set destination port number. Range: 1-65535.
Start Destination Port	Set start destination port number. Range: 1-65535.
End Destination Port	Set end destination port number. Range: 1-65535.
More Details	Show information of the port.
Interface List	
Interface	Select network interface for access control.
In ACL	Select a rule for incoming traffic from ACL ID.
Out ACL	Select a rule for outgoing traffic from ACL ID.

Table 3-3-2-2 ACL Parameters

3.3.2.3 DMZ

DMZ is a host within the internal network that has all ports exposed, except those forwarded ports in port mapping.

Figure 3-3-2-3

DMZ	
Item	Description
Enable	Enable or disable DMZ.
DMZ Host	Enter the IP address of the DMZ host on the internal network.
Source Address	Set the source IP address which can access to DMZ host. "0.0.0.0/0" means any address.

Table 3-3-2-3 DMZ Parameters

3.3.2.4 Port Mapping

Port mapping is an application of network address translation (NAT) that redirects a communication request from the combination of an address and port number to another while the packets are traversing a network gateway such as a gateway or firewall.

Click  to add a new port mapping rules.

Figure 3-3-2-4

Port Mapping	
Item	Description
Source IP	Specify the host or network which can access local IP address. 0.0.0.0/0 means all.
Source Port	Enter the TCP or UDP port from which incoming packets are forwarded. Range: 1-65535.
Destination IP	Enter the IP address that packets are forwarded to after being received on the incoming interface.
Destination Port	Enter the TCP or UDP port that packets are forwarded to after being received on the incoming port(s). Range: 1-65535.
Protocol	Select from "TCP" and "UDP" as your application required.
Description	The description of this rule.

Table 3-3-2-4 Port Mapping Parameters

Related Configuration Example

[NAT Application Example](#)

3.3.2.5 MAC Binding

MAC Binding is used for specifying hosts by matching MAC addresses and IP addresses that are in the list of allowed outer network access.

Figure 3-3-2-5

MAC Binding List	
Item	Description
MAC Address	Set the binding MAC address.

IP Address	Set the binding IP address.
Description	Fill in a description for convenience of recording the meaning of the binding rule for each piece of MAC-IP.

Table 3-3-2-5 MAC Binding Parameters

3.3.3 DHCP

UG67 can be set as a DHCP server to distribute IP address when Wi-Fi work as AP mode.

Figure 3-3-3-1

DHCP Server		
Item	Description	Default
Enable	Enable or disable DHCP server.	Enable
Interface	Only wlan interface is allowed to distribute IP addresses.	wlan0
Start Address	Define the beginning of the pool of IP addresses which will be leased to DHCP clients.	192.168.1.100
End Address	Define the end of the pool of IP addresses which will be leased to DHCP clients.	192.168.1.199
Netmask	Define the subnet mask of IP address obtained by DHCP clients from DHCP server.	255.255.255.0
Lease Time (Min)	Set the lease time on which the client can use the IP address obtained from DHCP server. Range: 1-10080.	1440
Primary	Set the primary DNS server.	114.114.114.114

DNS Server		
Secondary DNS Server	Set the secondary DNS server.	Null
Windows Name Server	Define the Windows Internet Naming Service obtained by DHCP clients from DHCP sever. Generally you can leave it blank.	Null
Static IP		
MAC Address	Set a static and specific MAC address for the DHCP client (it should be different from other MACs so as to avoid conflict).	Null
IP Address	Set a static and specific IP address for the DHCP client (it should be outside of the DHCP range).	Null

Table 3-3-3-1 DHCP Server Parameters

3.3.4 DDNS

Dynamic DNS (DDNS) is a method that automatically updates a name server in the Domain Name System, which allows user to alias a dynamic IP address to a static domain name. DDNS serves as a client tool and needs to coordinate with DDNS server. Before starting configuration, user shall register on a website of proper domain name provider and apply for a domain name.

The screenshot shows a web interface for DDNS configuration. At the top, there is a 'DDNS' header. Below it, a section titled 'DDNS Method List' contains a table with the following columns: Name, Interface, Service Type, Username, User ID, Password, Server, Server Path, Hostname, Append IP, and Operation. The 'Interface' column is set to 'wlan0' and the 'Service Type' column is set to 'DynDI'. There are input fields for the other columns, and a '+' button at the bottom right to add a new entry.

Figure 3-3-4-1

DDNS	
Item	Description
Name	Give the DDNS a descriptive name.
Interface	Set interface bundled with the DDNS.
Service Type	Select the DDNS service provider.
Username	Enter the username for DDNS register.
User ID	Enter User ID of the custom DDNS server.
Password	Enter the password for DDNS register.
Server	Enter the name of DDNS server.
Hostname	Enter the hostname for DDNS.
Append IP	Append your current IP to the DDNS server update path.

Table 3-3-4-1 DDNS Parameters

3.3.5 Link Failover

This section describes how to configure link failover strategies, such as VRRP strategies.

Configuration Steps

1. Define one or more SLA operations (ICMP probe).
2. Define one or more track objects to track the status of SLA operation.
3. Define applications associated with track objects, such as VRRP or static routing.

3.3.5.1 SLA

SLA setting is used for configuring link probe method. The default probe type is ICMP.

ID	Type	Destination Address	Secondary Destination Address	Data Size	Interval(s)	Timeout(ms)	Packet Loss Count	Start Time	Operation
1	icmp-ech	114.114.114.1	8.8.8.8	56	15	5000	3	nov	X

Figure 3-3-5-1

SLA		
Item	Description	Default
ID	SLA index. Up to 10 SLA settings can be added. Range: 1-10.	1
Type	ICMP-ECHO is the default type to detect if the link is alive.	icmp-echo
Destination Address	The detected IP address.	114.114.114.114
Secondary Destination Address	The secondary detected IP address.	8.8.8.8
Data Size	User-defined data size. Range: 0-1000.	56
Interval (s)	User-defined detection interval. Range: 1-608400.	30
Timeout (ms)	User-defined timeout for response to determine ICMP detection failure. Range: 1-300000.	5000
Packet Loss Count	Define packet loss count in each SLA probe. SLA probe fails when the preset packet loss count is exceeded.	5
Start Time	Detection start time; select from "Now" and blank character. Blank character means this SLA detection doesn't start.	now

Table 3-3-5-1 SLA Parameters

3.3.5.2 Track

Track setting is designed for achieving linkage among SLA module, Track module and Application module. Track setting is located between application module and SLA module with main function of shielding the differences of various SLA modules and providing unified interfaces for application module.

Linkage between Track Module and SLA module

Once you complete the configuration, the linkage relationship between Track module and SLA module will be established. SLA module is used for detection of link status, network performance and notification of Track module. The detection results help track status change timely.

- For successful detection, the corresponding track item is Positive.
- For failed detection, the corresponding track item is Negative.

Linkage between Track Module and Application Module

After configuration, the linkage relationship between Track module and Application module will be established. When any change occurs in track item, a notification that requires corresponding treatment will be sent to Application module.

Currently, the application modules like VRRP and static routing can get linkage with track module.

If it sends an instant notification to Application module, the communication may be interrupted in some circumstances due to routing's failure like timely restoration or other reasons. Therefore, user can set up a period of time to delay notifying application module when the track item status changes.

ID	Type	SLA ID	Interface	Negative Delay(s)	Positive Delay(s)	Operation
1	sla	1	wlan0	0	1	✕
+						

Figure 3-3-5-2

Item	Description	Default
Index	Track index. Up to 10 track settings can be configured. Range: 1-10.	1
Type	The options are "sla" and "interface".	SLA
SLA ID	Defined SLA ID.	1
Interface	Select the interface whose status will be detected.	cellular0
Negative Delay (s)	When interface is down or SLA probing fails, it will wait according to the time set here before actually changing its status to Down. Range: 0-180 (0 refers to immediate switching).	0

Positive Delay (s)	When failure recovery occurs, it will wait according to the time set here before actually changing its status to Up. Range: 0-180 (0 refers to immediate switching).	1
--------------------	----------------------------------------------------------------------------------------------------------------------------------------------------------------------	---

Table 3-3-5-2 Track Parameters

3.3.5.3 WAN Failover

WAN failover refers to failover between Ethernet WAN interface and cellular interface. When service transmission can't be carried out normally due to malfunction of a certain interface or lack of bandwidth, the rate of flow can be switched to backup interface quickly. Then the backup interface will carry out service transmission and share network flow so as to improve reliability of communication of data equipment.

When link state of main interface is switched from up to down, system will have the pre-set delay works instead of switching to link of backup interface immediately. Only if the state of main interface is still down after delay, will the system switch to link of backup interface. Otherwise, system will remain unchanged.

Main Interface	Backup Interface	Startup Delay(s)	Up Delay(s)	Down Delay(s)	Track ID	Operation
Cellular 0	eth 0	30	0	0	1	X

Figure 3-3-5-3

WAN Failover		
Parameters	Description	Default
Main Interface	Select a link interface as the main link.	--
Backup Interface	Select a link interface as the backup link.	--
Startup Delay (s)	Set how long to wait for the startup tracking detection policy to take effect. Range: 0-300.	30
Up Delay (s)	When the primary interface switches from failed detection to successful detection, switching can be delayed based on the set time. Range: 0-180 (0 refers to immediate switching)	0
Down Delay (s)	When the primary interface switches from successful detection to failed detection, switching can be delayed based on the set time. Range: 0-180 (0 refers to immediate switching).	0
Track ID	Track detection, select the defined track ID.	--

Table 3-3-5-3 WAN Failover Parameters

3.3.6 VPN

Virtual Private Networks, also called VPNs, are used to securely connect two private networks together so that devices can connect from one network to the other network via secure channels.

UG67 supports DMVPN, IPsec, GRE, L2TP, PPTP, OpenVPN, as well as GRE over IPsec and L2TP over IPsec.

3.3.6.1 DMVPN

A dynamic multi-point virtual private network (DMVPN), combining mGRE and IPsec, is a secure network that exchanges data between sites without passing traffic through an organization's headquarter VPN server or gateway.

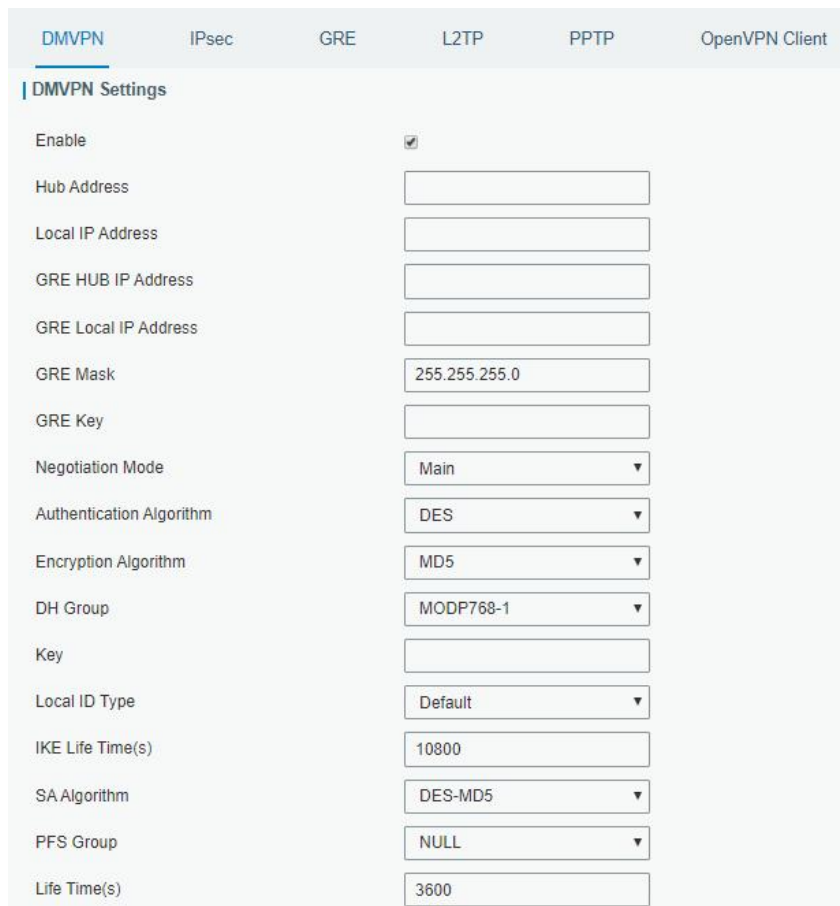

Figure 3-3-6-1



Figure 3-3-6-2

DMVPN	
Item	Description
Enable	Enable or disable DMVPN.
Hub Address	The IP address or domain name of DMVPN Hub.
Local IP address	DMVPN local tunnel IP address.

GRE Hub IP Address	GRE Hub tunnel IP address.
GRE Local IP Address	GRE local tunnel IP address.
GRE Netmask	GRE local tunnel netmask.
GRE Key	GRE tunnel key.
Negotiation Mode	Select from "Main" and "Aggressive".
Authentication Algorithm	Select from "DES", "3DES", "AES128", "AES192" and "AES256".
Encryption Algorithm	Select from "MD5" and "SHA1".
DH Group	Select from "MODP768_1", "MODP1024_2" and "MODP1536_5".
Key	Enter the preshared key.
Local ID Type	Select from "Default", "ID", "FQDN", and "User FQDN"
IKE Life Time (s)	Set the lifetime in IKE negotiation. Range: 60-86400.
SA Algorithm	Select from "DES_MD5", "DES_SHA1", "3DES_MD5", "3DES_SHA1", "AES128_MD5", "AES128_SHA1", "AES192_MD5", "AES192_SHA1", "AES256_MD5" and "AES256_SHA1".
PFS Group	Select from "NULL", "MODP768_1", "MODP1024_2" and "MODP1536-5".
Life Time (s)	Set the lifetime of IPsec SA. Range: 60-86400.
DPD Interval Time (s)	Set DPD interval time
DPD Timeout (s)	Set DPD timeout.
Cisco Secret	Cisco Nhrp key.
NHRP Holdtime (s)	The holdtime of Nhrp protocol.

Table 3-3-6-1 DMVPN Parameters

3.3.6.2 IPsec

IPsec is especially useful for implementing virtual private networks and for remote user access through dial-up connection to private networks. A big advantage of IPsec is that security arrangements can be handled without requiring changes to individual user computers.

IPsec provides three choices of security service: Authentication Header (AH), Encapsulating Security Payload (ESP), and Internet Key Exchange (IKE). AH essentially allows authentication of the senders' data. ESP supports both authentication of the sender and data encryption. IKE is used for cipher code exchange. All of them can protect one and more data flows between hosts, between host and gateway, and between gateways.

The screenshot shows the IPsec configuration interface. At the top, there are navigation tabs: DMVPN, IPsec (active), GRE, L2TP, and PPTP. Below the tabs is the 'IPsec Settings' section. A sub-section titled 'IPsec_1' contains the following configuration items:

- Enable:** A checked checkbox.
- IPsec Gateway Address:** An empty text input field.
- IPsec Mode:** A dropdown menu with 'Tunnel' selected.
- IPsec Protocol:** A dropdown menu with 'ESP' selected.
- Local Subnet:** An empty text input field.
- Local Subnet Mask:** An empty text input field.
- Local ID Type:** A dropdown menu with 'Default' selected.
- Remote Subnet:** An empty text input field.
- Remote Subnet Mask:** An empty text input field.
- Remote ID Type:** A dropdown menu with 'Default' selected.

Figure 3-3-6-3

IPsec	
Item	Description
Enable	Enable IPsec tunnel. A maximum of 3 tunnels is allowed.
IPsec Gateway Address	Enter the IP address or domain name of remote IPsec server.
IPsec Mode	Select from "Tunnel" and "Transport".
IPsec Protocol	Select from "ESP" and "AH".
Local Subnet	Enter the local subnet IP address that IPsec protects.
Local Subnet Netmask	Enter the local netmask that IPsec protects.
Local ID Type	Select from "Default", "ID", "FQDN", and "User FQDN".
Remote Subnet	Enter the remote subnet IP address that IPsec protects.
Remote Subnet Mask	Enter the remote netmask that IPsec protects.
Remote ID type	Select from "Default", "ID", "FQDN", and "User FQDN".

Table 3-3-6-2 IPsec Parameters

IKE Parameter	<input checked="" type="checkbox"/>
IKE Version	IKEv1
Negotiation Mode	Main
Encryption Algorithm	DES
Authentication Algorithm	MD5
DH Group	MODP768-1
Local Authentication	PSK
Local Secrets	
XAUTH	<input type="checkbox"/>
Lifetime(s)	10800
SA Parameter	<input checked="" type="checkbox"/>
SA Algorithm	DES-MD5
PFS Group	NULL
Lifetime(s)	3600
DPD Time Interval(s)	30
DPD Timeout(s)	150
IPsec Advanced	<input checked="" type="checkbox"/>
Enable Compression	<input type="checkbox"/>
VPN Over IPsec Type	NONE

Figure 3-3-6-4

IKE Parameter	
Item	Description
IKE Version	Select from "IKEv1" and "IKEv2".
Negotiation Mode	Select from "Main" and "Aggressive".
Encryption Algorithm	Select from "DES", "3DES", "AES128", "AES192" and "AES256".
Authentication Algorithm	Select from "MD5" and "SHA1"
DH Group	Select from "MODP768_1", "MODP1024_2" and "MODP1536_5".
Local Authentication	Select from "PSK" and "CA".
Local Secrets	Enter the preshared key.
XAUTH	Enter XAUTH username and password after XAUTH is enabled.
Lifetime (s)	Set the lifetime in IKE negotiation. Range: 60-86400.
SA Parameter	
SA Algorithm	Select from "DES_MD5", "DES_SHA1", "3DES_MD5", "3DES_SHA1", "AES128_MD5", "AES128_SHA1", "AES192_MD5", "AES192_SHA1", "AES256_MD5" and "AES256_SHA1".
PFS Group	Select from "NULL", "MODP768_1", "MODP1024_2" and "MODP1536_5".
Lifetime (s)	Set the lifetime of IPsec SA. Range: 60-86400.

DPD Interval Time(s)	Set DPD interval time to detect if the remote side fails.
DPD Timeout(s)	Set DPD timeout. Range: 10-3600.
IPsec Advanced	
Enable Compression	The head of IP packet will be compressed after it's enabled.
VPN Over IPsec Type	Select from "NONE", "GRE" and "L2TP" to enable VPN over IPsec function.

Table 3-3-6-3 IPsec Parameters

3.3.6.3 GRE

Generic Routing Encapsulation (GRE) is a protocol that encapsulates packets in order to route other protocols over IP networks. It's a tunneling technology that provides a channel through which encapsulated data message can be transmitted and encapsulation and decapsulation can be realized at both ends.

In the following circumstances the GRE tunnel transmission can be applied:

- GRE tunnel can transmit multicast data packets as if it were a true network interface. Single use of IPsec cannot achieve the encryption of multicast.
- A certain protocol adopted cannot be routed.
- A network of different IP addresses shall be required to connect other two similar networks.

The screenshot displays the 'GRE Settings' configuration page. At the top, there are tabs for 'DMVPN', 'IPsec', 'GRE' (selected), 'L2TP', and 'PPTP'. Below the tabs, the 'GRE Settings' section is visible, with a sub-section for 'GRE_1'. The settings include:

- Enable:** Checked (checkbox).
- Remote IP Address:** Empty text input field.
- Local IP Address:** Empty text input field.
- Local Virtual IP Address:** Empty text input field.
- Netmask:** Text input field containing '255.255.255.0'.
- Peer Virtual IP Address:** Empty text input field.
- Global Traffic Forwarding:** Unchecked (checkbox).
- Remote Subnet:** Empty text input field.
- Remote Netmask:** Empty text input field.
- MTU:** Text input field containing '1500'.
- Key:** Empty text input field.
- Enable NAT:** Checked (checkbox).

Figure 3-3-6-5

GRE	
Item	Description
Enable	Check to enable GRE function.

Remote IP Address	Enter the real remote IP address of GRE tunnel.
Local IP Address	Set the local IP address.
Local Virtual IP Address	Set the local tunnel IP address of GRE tunnel.
Netmask	Set the local netmask.
Peer Virtual IP Address	Enter remote tunnel IP address of GRE tunnel.
Global Traffic Forwarding	All the data traffic will be sent out via GRE tunnel when this function is enabled.
Remote Subnet	Enter the remote subnet IP address of GRE tunnel.
Remote Netmask	Enter the remote netmask of GRE tunnel.
MTU	Enter the maximum transmission unit. Range: 64-1500.
Key	Set GRE tunnel key.
Enable NAT	Enable NAT traversal function.

Table 3-3-6-4 GRE Parameters

3.3.6.4 L2TP

Layer Two Tunneling Protocol (L2TP) is an extension of the Point-to-Point Tunneling Protocol (PPTP) used by an Internet service provider (ISP) to enable the operation of a virtual private network (VPN) over the Internet.

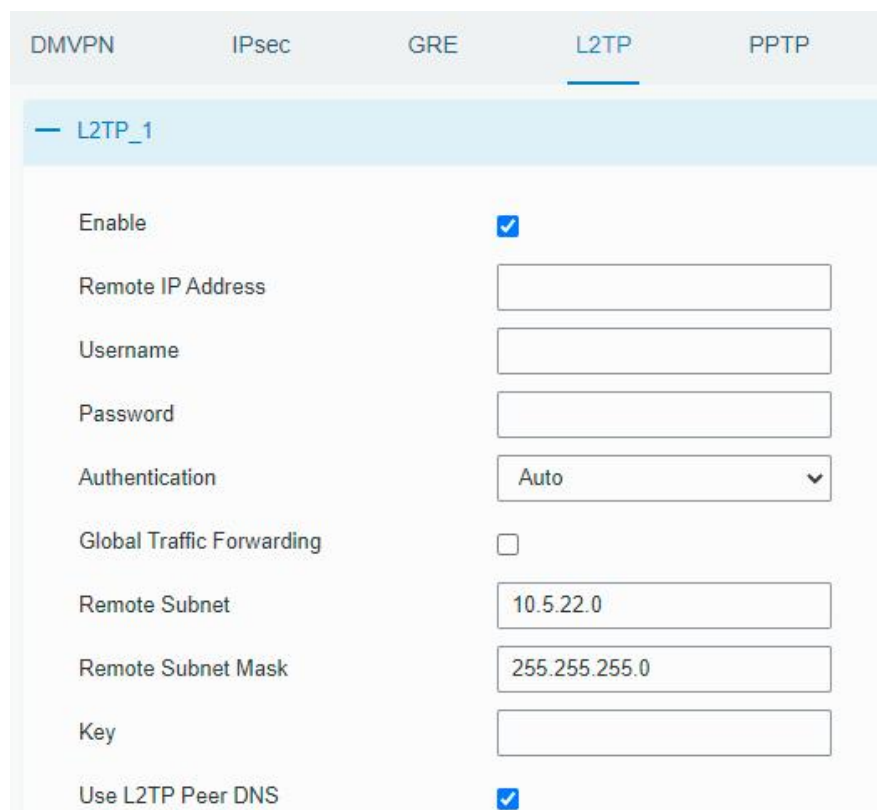

Figure 3-3-6-6

L2TP	
Item	Description
Enable	Check to enable L2TP function.
Remote IP Address	Enter the public IP address or domain name of L2TP server.

Username	Enter the username that L2TP server provides.
Password	Enter the password that L2TP server provides.
Authentication	Select from "Auto", "PAP", "CHAP", "MS-CHAPv1" and "MS-CHAPv2".
Global Traffic Forwarding	All of the data traffic will be sent out via L2TP tunnel after this function is enabled.
Remote Subnet	Enter the remote IP address that L2TP protects.
Remote Subnet Mask	Enter the remote netmask that L2TP protects.
Key	Enter the password of L2TP tunnel.
Use L2TP Peer DNS	Enable to use the DNS address of peer L2TP server .

Table 3-3-6-5 L2TP Parameters

Advanced Settings	<input checked="" type="checkbox"/>
Local IP Address	<input type="text"/>
Peer IP Address	<input type="text"/>
Enable NAT	<input checked="" type="checkbox"/>
Enable MPPE	<input checked="" type="checkbox"/>
Address/Control Compression	<input type="checkbox"/>
Protocol Field Compression	<input type="checkbox"/>
Asyncmap Value	<input type="text" value="ffffff"/>
MRU	<input type="text" value="1500"/>
MTU	<input type="text" value="1500"/>
Link Detection Interval(s)	<input type="text" value="60"/>
Max Retries	<input type="text" value="0"/>
Expert Options	<input type="text"/>

Figure 3-3-6-7

Advanced Settings	
Item	Description
Local IP Address	Set tunnel IP address of L2TP client. Client will obtain tunnel IP address automatically from the server when it's null.
Peer IP Address	Enter tunnel IP address of L2TP server.
Enable NAT	Enable NAT traversal function.
Enable MPPE	Enable MPPE encryption.
Address/Control Compression	For PPP initialization. User can keep the default option.
Protocol Field Compression	For PPP initialization. User can keep the default option.
Asyncmap Value	One of the PPP protocol initialization strings. User can keep the default value. Range: 0-ffffff.

MRU	Set the maximum receive unit. Range: 64-1500.
MTU	Set the maximum transmission unit. Range: 64-1500
Link Detection Interval (s)	Set the link detection interval time to ensure tunnel connection. Range: 0-600.
Max Retries	Set the maximum times of retry to detect the L2TP connection failure. Range: 0-10.
Expert Options	User can enter some other PPP initialization strings in this field and separate the strings with blank space.

Table 3-3-6-6 L2TP Parameters

3.3.6.5 PPTP

Point-to-Point Tunneling Protocol (PPTP) is a protocol that allows corporations to extend their own corporate network through private "tunnels" over the public Internet. Effectively, a corporation uses a wide-area network as a single large local area network.

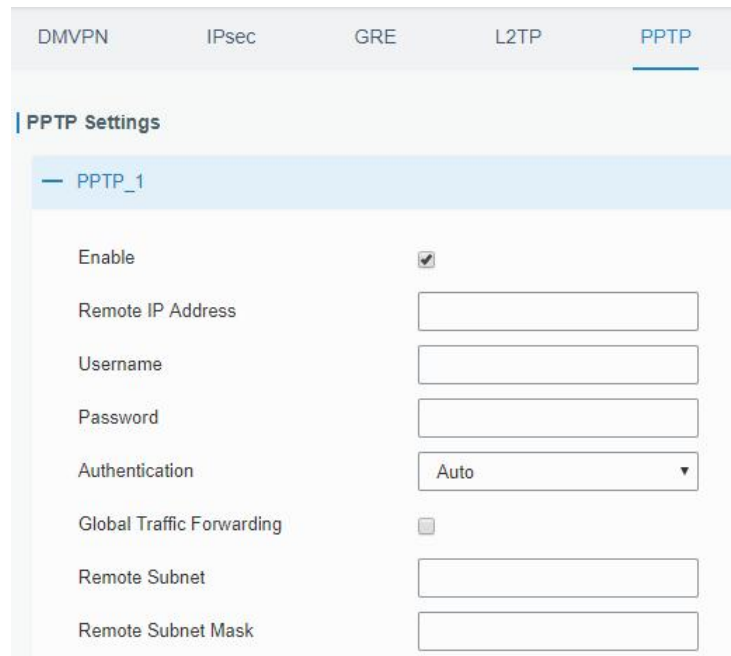

Figure 3-3-6-8

PPTP	
Item	Description
Enable	Enable PPTP client. A maximum of 3 tunnels is allowed.
Remote IP Address	Enter the public IP address or domain name of PPTP server.
Username	Enter the username that PPTP server provides.
Password	Enter the password that PPTP server provides.
Authentication	Select from "Auto", "PAP", "CHAP", "MS-CHAPv1", and "MS-CHAPv2".
Global Traffic Forwarding	All of the data traffic will be sent out via PPTP tunnel once enable this function.
Remote Subnet	Set the peer subnet of PPTP.

Remote Subnet Mask	Set the netmask of peer PPTP server.
--------------------	--------------------------------------

Table 3-3-6-7 PPTP Parameters

Advanced Settings	<input checked="" type="checkbox"/>
Local IP Address	<input type="text"/>
Peer IP Address	<input type="text"/>
Enable NAT	<input checked="" type="checkbox"/>
Enable MPPE	<input checked="" type="checkbox"/>
Address/Control Compression	<input type="checkbox"/>
Protocol Field Compression	<input type="checkbox"/>
Asyncmap Value	<input type="text" value="ffffff"/>
MRU	<input type="text" value="1500"/>
MTU	<input type="text" value="1500"/>
Link Detection Interval(s)	<input type="text" value="60"/>
Max Retries	<input type="text" value="0"/>
Expert Options	<input type="text"/>

Figure 3-3-6-9

PPTP Advanced Settings	
Item	Description
Local IP Address	Set IP address of PPTP client.
Peer IP Address	Enter tunnel IP address of PPTP server.
Enable NAT	Enable the NAT function of PPTP.
Enable MPPE	Enable MPPE encryption.
Address/Control Compression	For PPP initialization. User can keep the default option.
Protocol Field Compression	For PPP initialization. User can keep the default option.
Asyncmap Value	One of the PPP protocol initialization strings. User can keep the default value. Range: 0-ffffff.
MRU	Enter the maximum receive unit. Range: 0-1500.
MTU	Enter the maximum transmission unit. Range: 0-1500.
Link Detection Interval (s)	Set the link detection interval time to ensure tunnel connection. Range: 0-600.
Max Retries	Set the maximum times of retrying to detect the PPTP connection failure. Range: 0-10.
Expert Options	User can enter some other PPP initialization strings in this field and separate the strings with blank space.

Table 3-3-6-8 PPTP Parameters

3.3.6.6 OpenVPN Client

OpenVPN is an open source virtual private network (VPN) product that offers a simplified security framework, modular network design, and cross-platform portability.

Advantages of OpenVPN include:

- Security provisions that function against both active and passive attacks.
- Compatibility with all major operating systems.
- High speed (1.4 megabytes per second typically).
- Ability to configure multiple servers to handle numerous connections simultaneously.
- All encryption and authentication features of the OpenSSL library.
- Advanced bandwidth management.
- A variety of tunneling options.
- Compatibility with smart cards that support the Windows Crypt application program interface (API).

The screenshot displays the 'OpenVPN Client Settings' page. The 'OpenVPN_1' profile is selected. The configuration includes:

- Enable:**
- Protocol:** UDP
- Remote IP Address:** (empty field)
- Port:** 1194
- Interface:** tun
- Authentication:** None
- Local Tunnel IP:** (empty field)
- Remote Tunnel IP:** (empty field)
- Enable NAT:**
- Compression:** LZO
- Link Detection Interval(s):** 60
- Link Detection Timeout(s):** 300
- Cipher:** None
- MTU:** 1500
- Max Frame Size:** 1500
- Verbose Level:** ERROR
- Expert Options:** (empty field)

At the bottom, the 'Local Route' section has a table with columns: Subnet, Subnet Mask, and Operation. A plus sign icon is visible in the bottom right corner of the table area.

Figure 3-3-6-10

OpenVPN Client	
Item	Description
Enable	Enable OpenVPN client. A maximum of 3 tunnels is allowed.

Protocol	Select from "UDP" and "TCP".
Remote IP Address	Enter remote OpenVPN server's IP address or domain name.
Port	Enter the listening port number of remote OpenVPN server. Range: 1-65535.
Interface	Select from "tun" and "tap".
Authentication	Select from "None", "Pre-shared", "Username/Password", "X.509 cert", and "X.509 cert+user".
Local Tunnel IP	Set local tunnel address.
Remote Tunnel IP	Enter remote tunnel address.
Global Traffic Forwarding	All the data traffic will be sent out via OpenVPN tunnel when this function is enabled.
Enable TLS Authentication	Check to enable TLS authentication.
Username	Enter username provided by OpenVPN server.
Password	Enter password provided by OpenVPN server.
Enable NAT	Enable NAT traversal function.
Compression	Select LZO to compress data.
Link Detection Interval (s)	Set link detection interval time to ensure tunnel connection. Range: 10-1800.
Link Detection Timeout (s)	Set link detection timeout. OpenVPN will be reestablished after timeout. Range: 60-3600.
Cipher	Select from "NONE", "BF-CBC", "DE-CBC", "DES-EDE3-CBC", "AES-128-CBC", "AES-192-CBC" and "AES-256-CBC".
MTU	Enter the maximum transmission unit. Range: 128-1500.
Max Frame Size	Set the maximum frame size. Range: 128-1500.
Verbose Level	Select from "ERROR", "WARNING", "NOTICE" and "DEBUG".
Expert Options	User can enter some other initialization strings in this field and separate the strings with semicolon.
Local Route	
Subnet	Set the local route's IP address.
Subnet Mask	Set the local route's netmask.

Table 3-3-6-9 OpenVPN Client Parameters

3.3.6.7 OpenVPN Server

UG67 supports OpenVPN server to create secure point-to-point or site-to-site connections in routed or bridged configurations and remote access facilities.

DMVPN	IPsec	GRE	L2TP	PPTP	OpenVPN Client	OpenVPN Server
OpenVPN Server Settings						
Enable	<input type="checkbox"/>					
Protocol	UDP					
Port	1194					
Listening IP						
Interface	tun					
Authentication	None					
Local Virtual IP						
Remote Virtual IP						
Enable NAT	<input checked="" type="checkbox"/>					
Compression	LZO					
Link Detection Interval	60					
Cipher	None					
MTU	1500					
Max Frame Size	1500					
Verbose Level	ERROR					
Expert Options						

Figure 3-3-6-11

Local Route		
Subnet	Netmask	Operation
		<input style="background-color: #007bff; color: white; border: none; padding: 2px 5px; border-radius: 3px;" type="button" value="+"/>

Account		
Username	Password	Operation
		<input style="background-color: #007bff; color: white; border: none; padding: 2px 5px; border-radius: 3px;" type="button" value="+"/>

Figure 3-3-6-12

OpenVPN Server	
Item	Description
Enable	Enable/disable OpenVPN server.
Protocol	Select from TCP and UDP.
Port	Fill in listening port number. Range: 1-65535.
Listening IP	Enter WAN IP address or LAN IP address. Leaving it blank refers to all active WAN IP and LAN IP address.
Interface	Select from "tun" and "tap".
Authentication	Select from "None", "Pre-shared", "Username/Password", "X.509 cert" and "X.509 cert +user".
Local Virtual IP	The local tunnel address of OpenVPN's tunnel.

Remote Virtual IP	The remote tunnel address of OpenVPN's tunnel.
Client Subnet	Local subnet IP address of OpenVPN client.
Client Netmask	Local netmask of OpenVPN client.
Renegotiation Interval(s)	Set interval for renegotiation. Range: 0-86400.
Max Clients	Maximum OpenVPN client number. Range: 1-128.
Enable CRL	Enable CRL
Enable Client to Client	Allow access between different OpenVPN clients.
Enable Dup Client	Allow multiple users to use the same certification.
Enable NAT	Check to enable the NAT traversal function.
Compression	Select "LZO" to compress data.
Link Detection Interval	Set link detection interval time to ensure tunnel connection. Range: 10-1800.
Cipher	Select from "NONE", "BF-CBC", "DES-CBC", "DES-EDE3-CBC", "AES-128-CBC", "AES-192-CBC" and "AES-256-CBC".
MTU	Enter the maximum transmission unit. Range: 64-1500.
Max Frame Size	Set the maximum frame size. Range: 64-1500.
Verbose Level	Select from "ERROR", "WARNING", "NOTICE" and "DEBUG".
Expert Options	User can enter some other initialization strings in this field and separate the strings with semicolon..
Local Route	
Subnet	The real local IP address of OpenVPN client.
Netmask	The real local netmask of OpenVPN client.
Account	
Username & Password	Set username and password for OpenVPN client.

Table 3-3-6-10 OpenVPN Server Parameters

3.3.6.8 Certifications

User can import/export certificate and key files for OpenVPN and IPsec on this page.

Figure 3-3-6-13

OpenVPN Client	
Item	Description
CA	Import/Export CA certificate file.

Public Key	Import/Export public key file.
Private Key	Import/Export private key file.
TA	Import/Export TA key file.
Preshared Key	Import/Export static key file.
PKCS12	Import/Export PKCS12 certificate file.

Table 3-3-6-11 OpenVPN Client Certification Parameters

OpenVPN Server

— OpenVPN Server

CA	<input type="text"/>	Browse	Import	Export	Delete
Public Key	<input type="text"/>	Browse	Import	Export	Delete
Private Key	<input type="text"/>	Browse	Import	Export	Delete
DH	<input type="text"/>	Browse	Import	Export	Delete
TA	<input type="text"/>	Browse	Import	Export	Delete
CRL	<input type="text"/>	Browse	Import	Export	Delete
Preshared Key	<input type="text"/>	Browse	Import	Export	Delete

Figure 3-3-6-14

OpenVPN Server	
Item	Description
CA	Import/Export CA certificate file.
Public Key	Import/Export public key file.
Private Key	Import/Export private key file.
DH	Import/Export DH key file.
TA	Import/Export TA key file.
CRL	Import/Export CRL.
Preshared Key	Import/Export static key file.

Table 3-3-6-12 OpenVPN Server Parameters

IPsec

— IPsec_1

CA	<input type="text"/>	Browse	Import	Export	Delete
Client Key	<input type="text"/>	Browse	Import	Export	Delete
Server Key	<input type="text"/>	Browse	Import	Export	Delete
Private Key	<input type="text"/>	Browse	Import	Export	Delete
CRL	<input type="text"/>	Browse	Import	Export	Delete

Figure 3-3-6-15

IPsec	
Item	Description
CA	Import/Export CA certificate.
Client Key	Import/Export client key.
Server Key	Import/Export server key.
Private Key	Import/Export private key.
CRL	Import/Export certificate recovery list.

Table 3-3-6-13 IPsec Parameters

3.4 System

This section describes how to configure general settings, such as administration account, access service, system time, common user management, SNMP, event alarms, etc.

3.4.1 General Settings

3.4.1.1 General

General settings include system info, access service and HTTPS certificates.

Figure 3-4-1-1

General		
Item	Description	Default
System		
Hostname	User-defined gateway name, needs to start with a letter.	GATEWAY

Web Login Timeout (s)	You need to log in again if it times out. Range: 100-3600.	1800
Access Service		
Port	Set port number of the services. Range: 1-65535.	--
HTTP	Users can log in the device locally via HTTP to access and control it through Web after the option is checked.	80
HTTPS	Users can log in the device locally and remotely via HTTPS to access and control it through Web after option is checked.	443
TELNET	Users can log in the device locally and remotely via TELNET to access and control it through Web after option is checked.	23
SSH	Users can log in the device locally and remotely via SSH after the option is checked.	22
HTTPS Certificates		
Certificate	Click "Browse" button, choose certificate file on the PC, and then click "Import" button to upload the file into gateway. Click "Export" button will export the file to the PC. Click "Delete" button will delete the file.	--
Key	Click "Browse" button, choose key file on the PC, and then click "Import" button to upload the file into gateway. Click "Export" button will export file to the PC. Click "Delete" button will delete the file.	--

Table 3-4-1-1 General Setting Parameters

3.4.1.2 System Time

This section explains how to set the system time including time zone and time synchronization type.

Note: to ensure that the gateway runs with the correct time, it's recommended that you set the system time when configuring the gateway.

Figure 3-4-1-2

The screenshot shows the 'System Time' settings page. The 'Current Time' is 2019-06-12 20:33:59 Wed. The 'Time Zone' is set to '8 China (Beijing)'. The 'Sync Type' is 'Set up Manually'. The 'Date' is 2019-06-12 and the 'Time' is 20:33:59.

Figure 3-4-1-3

The screenshot shows the 'System Time' settings page. The 'Current Time' is 2019-06-12 20:33:36 Wed. The 'Time Zone' is '8 China (Beijing)'. The 'Sync Type' is 'Sync with NTP Server'. The 'NTP Server Address' is '1.cn.pool.ntp.org'. The 'Enable NTP Server' checkbox is unchecked.

Figure 3-4-1-4

System Time	
Item	Description
Current Time	Show the current system time.
Time Zone	Click the drop down list to select the time zone you are in.
Sync Type	Click the drop down list to select the time synchronization type.
Sync with Browser	Synchronize time with browser.
Browser Time	Show the current time of browser.
Set up Manually	Manually configure the system time.
Sync with NTP Server	Synchronize time with NTP server so as to achieve time synchronization of all devices equipped with a clock on network.
Sync with NTP Server	
NTP Server Address	Set NTP server address (domain name/IP).
Enable NTP Server	NTP client on the network can achieve time synchronization with gateway after "Enable NTP Server" option is checked.

Table 3-4-1-2 System Time Parameters

3.4.1.3 SMTP

SMTP, short for Simple Mail Transfer Protocol, is a TCP/IP protocol used in sending and receiving e-mail. This section describes how to configure email settings.

Figure 3-4-1-5

SMTP	
Item	Description
SMTP Client Settings	
Enable	Enable or disable SMTP client function.
Email Address	Enter the sender's email account.
Password	Enter the sender's email password.
SMTP Server Address	Enter SMTP server's domain name.
Port	Enter SMTP server port. Range: 1-65535.
Enable TLS	Enable or disable TLS encryption.

Table 3-4-1-3 SMTP Setting

Related Topics

[Events Setting](#)

3.4.1.4 Phone

Phone settings involve in call/SMS trigger and SMS alarm for events. This is only applied to gateway with cellular feature.

Name	Number	Operation
List1	654321;123456	✕
		+

Save

Figure 3-4-1-6

Phone	
Item	Description
Phone Number List	
Name	Set phone group name.
Number	Enter the telephone number. Digits, "+" and "-" are allowed. You can divide multiple numbers by ";".

Table 3-4-1-4 Phone Settings

Related Topic

[Connect on Demand](#)

3.4.1.5 Email

Email settings involve email alarm for events.

Name	Email Address	Operation
list1	sam@user.com;hot@gmail.com	✕
		+

Save

Figure 3-4-1-7

Email	
Item	Description
Email List	
Name	Set Email group name.
Email Address	Enter the Email address. You can divide multiple Email addresses by ";".

Table 3-4-1-5 Email Settings

3.4.2 User Management

3.4.2.1 Account

Here you can change the login username and password of the administrator.

Note: it is strongly recommended that you modify them for the sake of security.

The screenshot shows a web interface with two tabs: 'Account' and 'User Management'. The 'Account' tab is active. Below the tabs is a section titled 'Change Account Info'. It contains four input fields: 'Username' with the value 'admin', 'Old Password', 'New Password', and 'Confirm New Password'. A blue 'Save' button is located at the bottom left of the form.

Figure 3-4-2-1

Account	
Item	Description
Username	Enter a new username. You can use characters such as a-z, 0-9, "_", "-", "\$". The first character can't be a digit.
Old Password	Enter the old password.
New Password	Enter a new password.
Confirm New Password	Enter the new password again.

Table 3-4-2-1 Account Information

3.4.2.2 User Management

This section describes how to create common user accounts.

The common user permission includes Read-Only and Read-Write.

The screenshot shows a web interface with two tabs: 'Account' and 'User Management'. The 'User Management' tab is active. Below the tabs is a section titled 'User List'. It contains a table with four columns: 'Username', 'Password', 'Permission', and 'Operation'. There are two rows of user data. The first row has 'steve' as the username, a masked password, 'Read-Write' as the permission, and a delete icon (X). The second row has 'test' as the username, a masked password, 'Read-Only' as the permission, and a delete icon (X). At the bottom right of the table is an add icon (+).

Figure 3-4-2-2

User Management	
Item	Description
Username	Enter a new username. You can use characters such as a-z, 0-9, "_", "-", "\$". The first character can't be a digit.
Password	Set password.

Permission	<p>Select user permission from “Read-Only” and “Read-Write”.</p> <ul style="list-style-type: none"> - Read-Only: users can only view the configuration of gateway in this level. - Read-Write: users can view and set the configuration of gateway in this level.
------------	-------------------------------------------------------------------------------------------------------------------------------------------------------------------------------------------------------------------------------------------------------------------------------------------

Table 3-4-2-2 User Management

3.4.3 SNMP

SNMP is widely used in network management for network monitoring. SNMP exposes management data with variables form in managed system. The system is organized in a management information base (MIB) which describes the system status and configuration. These variables can be remotely queried by managing applications.

Configuring SNMP in networking, NMS, and a management program of SNMP should be set up at the Manager.

Configuration steps are listed as below for achieving query from NMS:

1. Enable SNMP setting.
2. Download MIB file and load it into NMS.
3. Configure MIB View.
4. Configure VCAM.

3.4.3.1 SNMP

UG67 supports SNMPv1, SNMPv2c and SNMPv3 version. SNMPv1 and SNMPv2c employ community name authentication. SNMPv3 employs authentication encryption by username and password.

Figure 3-4-3-1

SNMP Settings	
Item	Description
Enable	Enable or disable SNMP function.
Port	Set SNMP listened port. Range: 1-65535. The default port is 161.
System Name	Fill in the system name to represent the gateway.
SNMP Version	Select SNMP version; support SNMP v1/v2c/v3.
Location Information	Fill in the location information.
Contact Information	Fill in the contact information.

Table 3-4-3-1 SNMP Parameters

3.4.3.2 MIB View

This section explains how to configure MIB view for the objects.

View Name	View Filter	View OID	Operation
All	Included	1	×
system	Included	1.3.6.1.2.1.1	×

Figure 3-4-3-2

MIB View	
Item	Description
View Name	Set MIB view's name.
View Filter	Select from "Included" and "Excluded".
View OID	Enter the OID number.
Included	You can query all nodes within the specified MIB node.
Excluded	You can query all nodes except for the specified MIB node.

Table 3-4-3-2 MIB View Parameters

3.4.3.3 VACM

This section describes how to configure VCAM parameters.

Community	Permission	MIB View	Network	Operation
private	Read-write	All	0.0.0.0/0	X
public	Read-only	none	0.0.0.0/0	X
				+

Figure 3-4-3-3

VACM	
Item	Description
SNMP v1 & v2 User List	
Community	Set the community name.
Permission	Select from "Read-Only" and "Read-Write".
MIB View	Select an MIB view to set permissions from the MIB view list.
Network	The IP address and bits of the external network accessing the MIB view.
Read-Write	The permission of the specified MIB node is read and write.
Read-Only	The permission of the specified MIB node is read only.
SNMP v3 User List	
Group Name	Set the name of SNMPv3 group.
Security Level	Select from "NoAuth/NoPriv", "Auth/NoPriv", and "Auth/Priv".
Read-Only View	Select an MIB view to set permission as "Read-only" from the MIB view list.
Read-Write View	Select an MIB view to set permission as "Read-write" from the MIB view list.
Inform View	Select an MIB view to set permission as "Inform" from the MIB view list.

Table 3-4-3-3 VACM Parameters

3.4.3.4 Trap

This section explains how to enable network monitoring by SNMP trap.

SNMP	MIB View	VACM	Trap	MIB
SNMP Trap				
Enable	<input checked="" type="checkbox"/>			
SNMP Version	SNMPv2			
Server Address	<input type="text"/>			
Port	<input type="text"/>			
Name	<input type="text"/>			

Figure 3-4-3-4

SNMP Trap	
Item	Description
Enable	Enable or disable SNMP Trap function.
SNMP Version	Select SNMP version; support SNMP v1/v2c/v3.
Server Address	Fill in NMS's IP address or domain name.
Port	Fill in UDP port. Port range is 1-65535. The default port is 162.
Name	Fill in the group name when using SNMP v1/v2c; fill in the username when using SNMP v3.
Auth/Priv Mode	Select from "NoAuth & No Priv", "Auth & NoPriv", and "Auth & Priv".

Table 3-4-3-4 Trap Parameters

3.4.3.5 MIB

This section describes how to download MIB files.

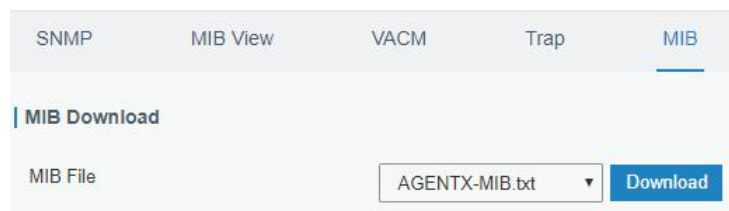

Figure 3-4-3-5

MIB	
Item	Description
MIB File	Select the MIB file you need.
Download	Click "Download" button to download the MIB file to PC.

Table 3-4-3-5 MIB Download

3.4.4 Device Management

You can connect the device to the DeviceHub on this page so as to manage the gateway centrally and remotely. For details refer to DeviceHub User Guide.

Figure 3-4-5-1

DeviceHub	
Item	Description
Status	Show the connection status between the gateway and the DeviceHub.
Disconnected	Click this button to disconnect the gateway from the DeviceHub.
Activation Server Address	IP address or domain of the DeviceHub.
DeviceHub Server Address	The URL address for the device to connect to the DeviceHub, e.g. http://220.82.63.79:8080/acs.
Activation Method	Select activation method to connect the gateway to the DeviceHub server, options are "By Authentication ID" and "By ID".
Authentication Code	Fill in the authentication code generated from the DeviceHub.
ID	Fill in the registered DeviceHub account (email) and password.
Password	

Table 3-4-5-1

3.4.5 Events

Event feature is capable of sending alerts by Email when certain system events occur.

3.4.5.1 Events

You can view alarm messages on this page.

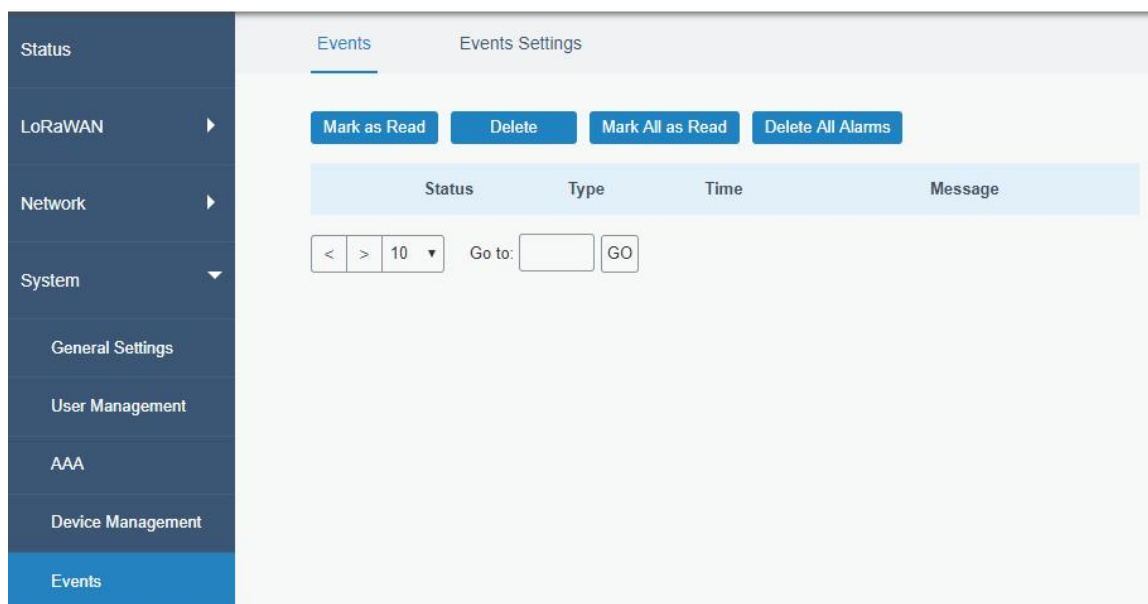

Figure 3-4-6-1

Events	
Item	Description
Mark as Read	Mark the selected event alarm as read.
Delete	Delete the selected event alarm.
Mark All as Read	Mark all event alarms as read.
Delete All Alarms	Delete all event alarms.
Status	Show the reading status of the event alarms, such as "Read" and "Unread".
Type	Show the event type that should be alarmed.
Time	Show the alarm time.
Message	Show the alarm content.

Table 3-4-6-1 Events Parameters

3.4.5.2 Events Settings

In this section, you can decide what events to record and whether you want to receive email and SMS notifications when any change occurs.

Events [Events Settings](#)

Events Settings

Enable

Phone for Notification

Email for Notification

Events	Record	Email Email Setting	SMS SMS Setting
Cellular Up	<input type="checkbox"/>	<input type="checkbox"/>	<input type="checkbox"/>
Cellular Down	<input type="checkbox"/>	<input type="checkbox"/>	<input type="checkbox"/>
WAN Up	<input type="checkbox"/>	<input type="checkbox"/>	<input type="checkbox"/>
WAN Down	<input type="checkbox"/>	<input type="checkbox"/>	<input type="checkbox"/>
VPN Up	<input type="checkbox"/>	<input type="checkbox"/>	<input type="checkbox"/>
VPN Down	<input type="checkbox"/>	<input type="checkbox"/>	<input type="checkbox"/>
Power On	<input type="checkbox"/>	<input type="checkbox"/>	<input type="checkbox"/>
Power Off	<input type="checkbox"/>	<input type="checkbox"/>	<input type="checkbox"/>

Figure 3-4-6-2

Event Settings	
Item	Description
Enable	Check to enable "Events Settings".
Cellular Up	Cellular network is connected.
Cellular Down	Cellular network is disconnected.
WAN Up	Ethernet cable is connected to WAN port.
WAN Down	Ethernet cable is disconnected to WAN port.
VPN Up	VPN is connected.
VPN Down	VPN is disconnected.
Power On	The gateway has powered on.
Power Off	The gateway has powered off.
Record	The relevant content of event alarm will be recorded on "Event" page if this option is checked.
Email	The relevant content of event alarm will be sent out via email if this option is checked.
Email Setting	Click and you will be redirected to the page "Email" to configure the Email group.
SMS	The relevant content of event alarm will be sent out via SMS if this option is checked.
SMS Setting	Click and you will be redirected to the page of "Phone" to configure phone group list.

Phone Group List	Select phone group to receive SMS alarm.
Email Group List	Select Email group to receive Email alarm.

Table 3-4-6-2 Events Parameters

Related Topics

[Email Setting](#)

[Phone Setting](#)

3.5 Maintenance

This section describes system maintenance tools and management.

3.5.1 Tools

Troubleshooting tools includes ping and traceroute.

3.5.1.1 Ping

Ping tool is engineered to ping outer network.

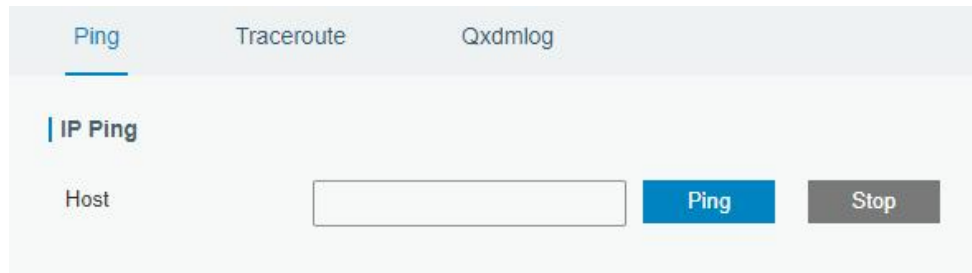

Figure 3-5-1-1

PING	
Item	Description
Host	Ping outer network from the gateway.

Table 3-5-1-1 IP Ping Parameters

3.5.1.2 Traceroute

Traceroute tool is used for troubleshooting network routing failures.

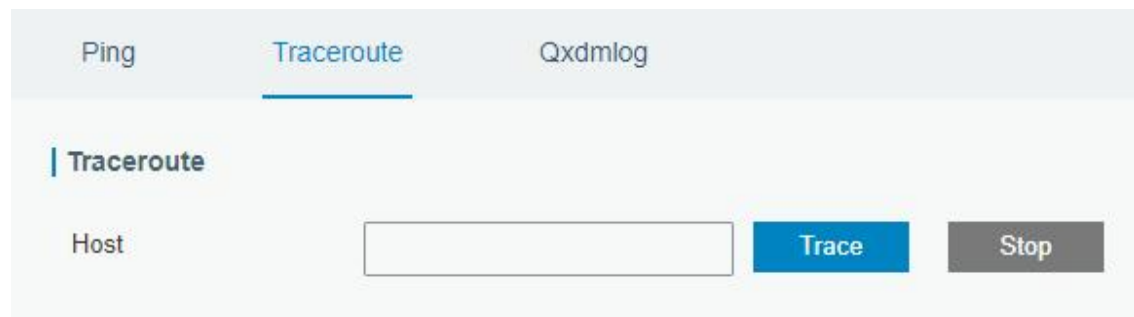

Figure 3-5-1-2

Traceroute	
Item	Description
Host	Address of the destination host to be detected.

Table 3-5-1-2 Traceroute Parameters

3.5.1.3 Qxdmlog

This section allow collecting diagnostic logs via QXDM tool.



Figure 3-5-1-3

3.5.2 Schedule

This section explains how to configure scheduled reboot on the gateway.

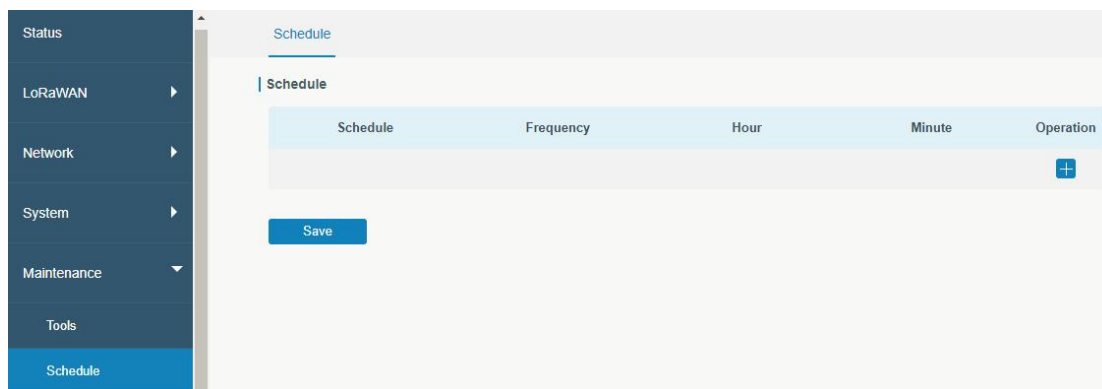

Figure 3-5-2-1

Schedule	
Item	Description
Schedule	Select schedule type.
Reboot	Reboot the gateway regularly.
Frequency	Select the frequency to execute the schedule.
Hour & Minute	Select the time to execute the schedule.

Table 3-5-2-1 Schedule Parameters

3.5.3 Log

The system log contains a record of informational, error and warning events that indicates how the system processes. By reviewing the data contained in the log, an administrator or user troubleshooting the system can identify the cause of a problem or whether the system

processes are loading successfully. Remote log server is feasible, and gateway will upload all system logs to remote log server such as Syslog Watcher.

3.5.3.1 System Log

This section describes how to download log file and view the recent log on web.

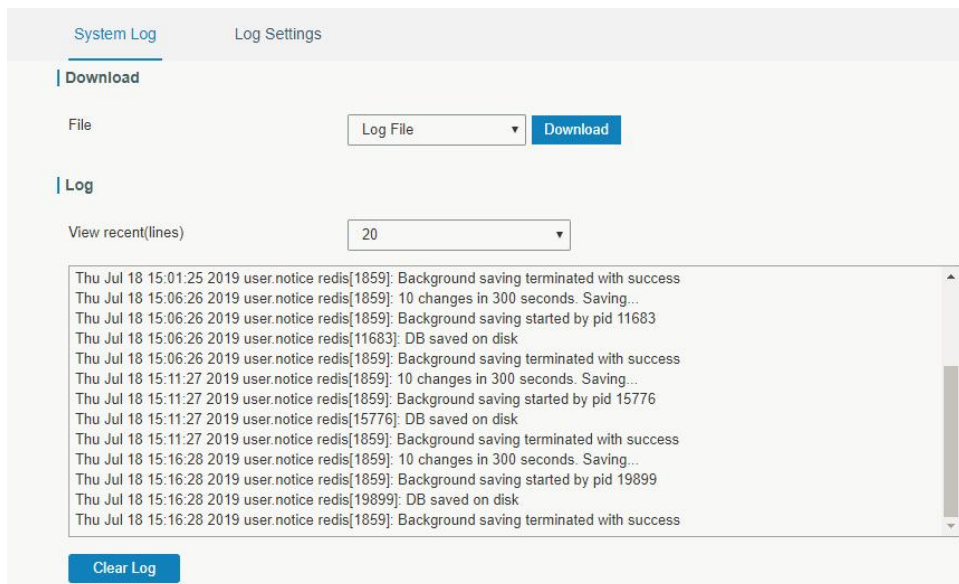

Figure 3-5-3-1

System Log	
Item	Description
Download	Download log file.
View recent (lines)	View the specified lines of system log.
Clear Log	Clear the current system log.

Table 3-5-3-1 System Log Parameters

3.5.3.2 Log Settings

This section explains how to enable remote log server and local log setting.

Figure 3-5-3-2

Log Settings	
Item	Description
Remote Log Server	
Enable	With “Remote Log Server” enabled, gateway will send all system logs to the remote server.
Syslog Server Address	Fill in the remote system log server address (IP/domain name).
Port	Fill in the remote system log server port.
Local Log File	
Storage	User can store the log file in memory or TF card.
Size	Set the size of the log file to be stored.
Log Severity	The list of severities follows the syslog protocol.

Table 3-5-3-2 System Log Parameters

3.5.4 Upgrade

This section describes how to upgrade the gateway firmware via web. Generally you don't need to do the firmware upgrade.

Note: any operation on web page is not allowed during firmware upgrade, otherwise the upgrade will be interrupted, or even the device will break down.

Figure 3-5-4-1

Upgrade	
Item	Description
Firmware Version	Show the current firmware version.
Reset Configuration to Factory Default	When this option is checked, the gateway will be reset to factory defaults after upgrade.
Upgrade Firmware	Click "Browse" button to select the new firmware file, and click "Upgrade" to upgrade firmware.

Table 3-5-4-1 Upgrade Parameters

Related Configuration Example

[Firmware Upgrade](#)

3.5.5 Backup and Restore

This section explains how to create a complete backup of the whole system configurations to a file, replicate parts of important configuration only for batch backup, restore the config file to the gateway and reset to factory defaults.

Figure 3-5-5-1

Backup and Restore	
Item	Description
Config File	Click "Browse" button to select configuration file, and then click "Import" button to upload the configuration file to the gateway.
Full Backup	Click "Full Backup" to export the current configuration file to the PC.
Batch Backup	Click "Batch Backup" to export current configuration except gateway ID of packet forwarder, all embedded NS settings, static IP address of WAN, WLAN settings, user management settings, DeviceHub authentication code, all APP settings.
Reset	Click "Reset" button to reset factory default settings. gateway will restart after reset process is done.

Table 3-5-5-1 Backup and Restore Parameters

Related Configuration Example

[Restore Factory Defaults](#)

3.5.6 Reboot

On this page you can reboot the gateway and return to the login page. We strongly recommend clicking "Save" button before rebooting the gateway so as to avoid losing the new configuration.

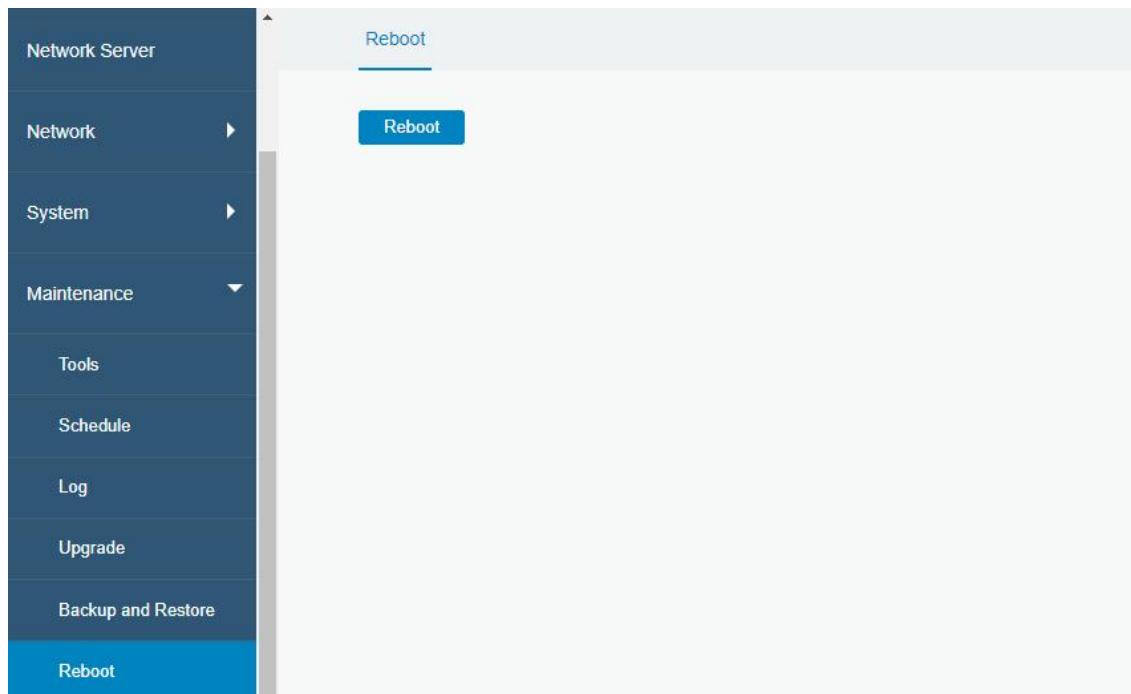

Figure 3-5-6-1

3.6 APP

3.6.1 Python

Python is an object-oriented programming language that has gained popularity because of its clear syntax and readability.

As an interpreted language, Python has a design philosophy that emphasizes code readability, notably using whitespace indentation to delimit code blocks rather than curly brackets or keywords, and a syntax that allows programmers to express concepts in fewer lines of code than it's used in other languages such as C++ or Java. The language provides constructs and intends to enable writing clear programs on both small and large scale.

Users can use Python to quickly generate the prototype of the program, which can be the final interface of the program, rewrite it with a more appropriate language, and then encapsulate the extended class library that Python can call.

This section describes how to view the relevant running status such as App-manager, SDK version, extended storage, etc. Also you can change the App-manager configuration, and import the Python App package from here.

3.6.1.1 Python

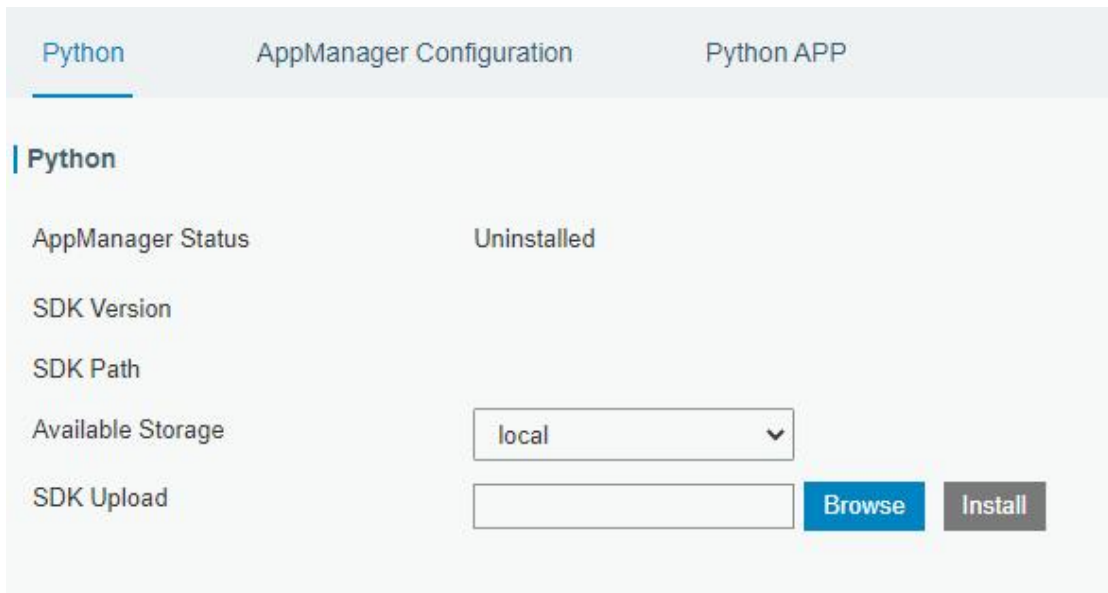

Figure 3-6-1-1

Python	
Item	Description
AppManager Status	Show AppManager's running status, like "Uninstalled", "Running" or "Stopped".
SDK Version	Show the version of the installed SDK.
SDK Path	Show the SDK installation path.
Available Storage	Select available storage to install SDK.
SDK Upload	Upload and install SDK for Python.
Uninstall	Uninstall SDK.

View	View application status managed by AppManager.
------	------------------------------------------------

Table 3-6-1-1 Python Parameters

3.6.1.2 App Manager Configuration

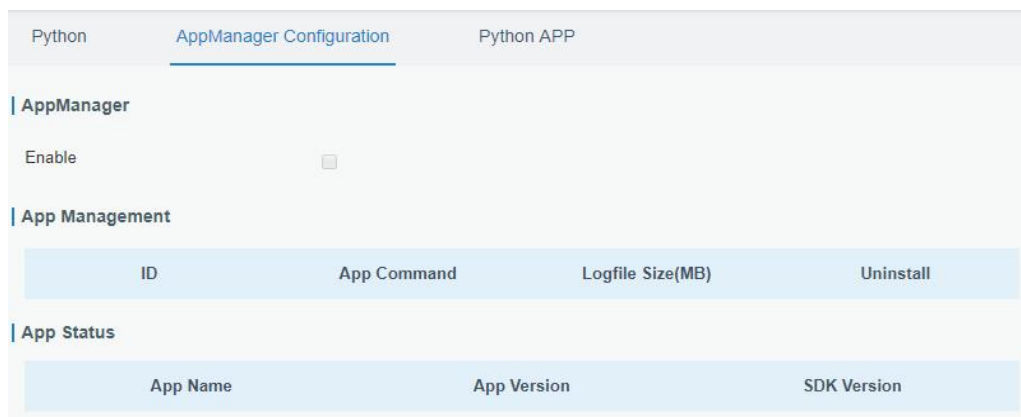

Figure 3-6-1-2

AppManager Configuration	
Item	Description
Enable	After enabling Python AppManager, user can click "View" button on the "Python" webpage to view the application status managed by AppManager.
App Management	
ID	Show the ID of the imported App.
App Command	Show the name of the imported App.
Logfile Size(MB)	User-defined Logfile size. Range: 1-50.
Uninstall	Uninstall APP.
App Status	
App Name	Show the name of the imported App.
App Version	Show the version of the imported App.
SDK Version	Show the SDK version which the imported App is based on.

Table 3-6-1-2 APP Manager Parameters

3.6.1.3 Python App

The screenshot shows the 'Python APP' configuration page. It has three tabs: 'Python', 'AppManager Configuration', and 'Python APP' (which is active). The page is organized into three sections:

- Import App Package:** Contains an 'App Package' input field with a 'Browse' button and an 'Import' button.
- Import App Configuration:** Contains an 'App Name' dropdown menu, an 'App Configuration' input field with a 'Browse' button, and an 'Import' button.
- Debug Script:** Contains a 'Debug File' dropdown menu with an 'Export' button, and a 'Debug Script' input field with 'Browse' and 'Import' buttons.

Figure 3-6-1-3

Python APP	
Item	Description
App Package	Select App package and import.
App Name	Select App to import configuration.
App Configuration	Select configuration file and import.
Debug File	Export script file.
Debug Script	Select Python script to be debugged and import.

Table 3-6-1-3 APP Parameters

3.6.2 Node-RED

Node-RED is a flow-based development tool for visual programming and wiring together hardware devices, APIs and online services as part of the Internet of Things. Node-RED provides a web-browser-based flow editor, which can easily wire together flows using the wide range of nodes in the palette. Besides basic nodes, Milesight gateways provide following customized nodes:

- LoRa Input: receive the LoRa data, please ensure the network server mode is enabled before using this node
- LoRa Output: send downlinks to LoRaWAN® nodes
- Device Filter: filter out the data of one or more specific LoRaWAN® nodes
- Decoder: decode the Milesight LoRaWAN® end nodes data

- GW Info: monitor alarm messages of gateway, please ensure the event detection is enabled in “General -> Events -> Events Settings”
- Email Output: send LoRa data or gateway alarms via email
- SMS Input: receive SMS message. This only works when cellular is connected
- SMS Output: send SMS message. This only works when cellular is connected

3.6.2.1 Node-RED

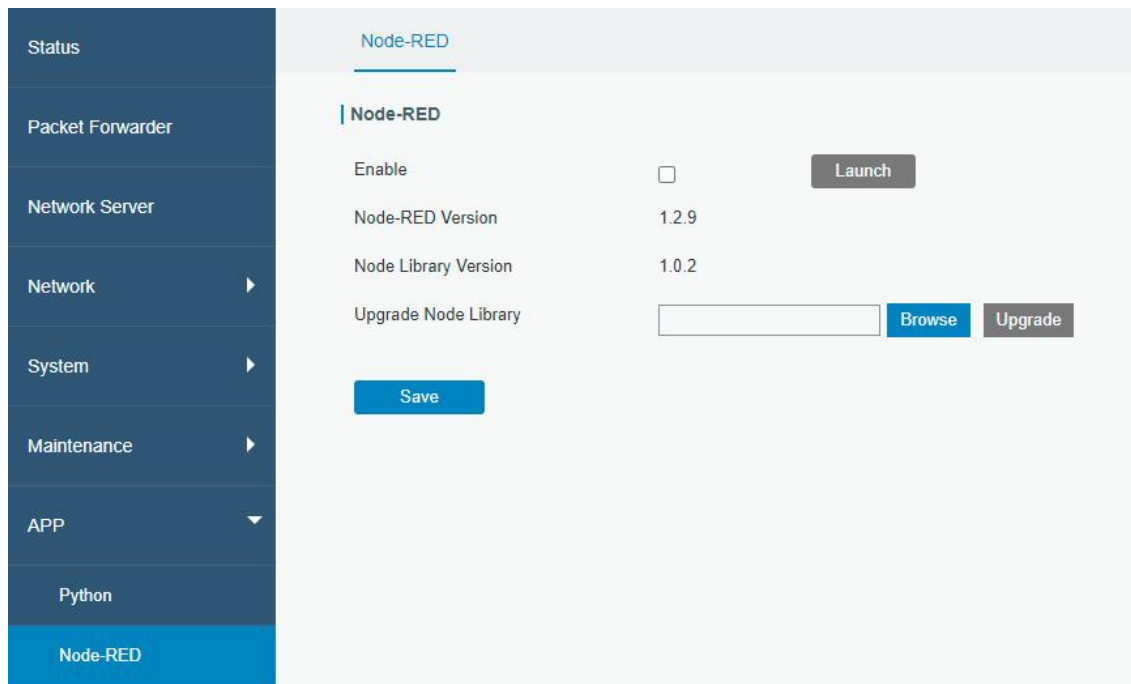

Figure 3-6-2-1

Node-RED	
Item	Description
Enable	Enable the Node-RED.
Launch	Click to launch the web GUI of Node-RED.
Node-RED Version	Show the version of the Node-RED. Node-RED version can be upgraded only when you upgrade the gateway.
Node Library Version	Show the version of the node library.
Upgrade Node Library	Upgrade the node library by importing the library package.

Table 3-6-2-1 Node-RED Parameters

Related Configuration Example

[Node-RED](#)

Chapter 4 Application Examples

4.1 Restore Factory Defaults

4.1.1 Via Web Interface

1. Log in web interface, and go to “Maintenance > Backup and Restore”.
2. Click “Reset” button under the “Restore Factory Defaults”.

You will be asked to confirm if you'd like to reset it to factory defaults. Then click “Reset” button.

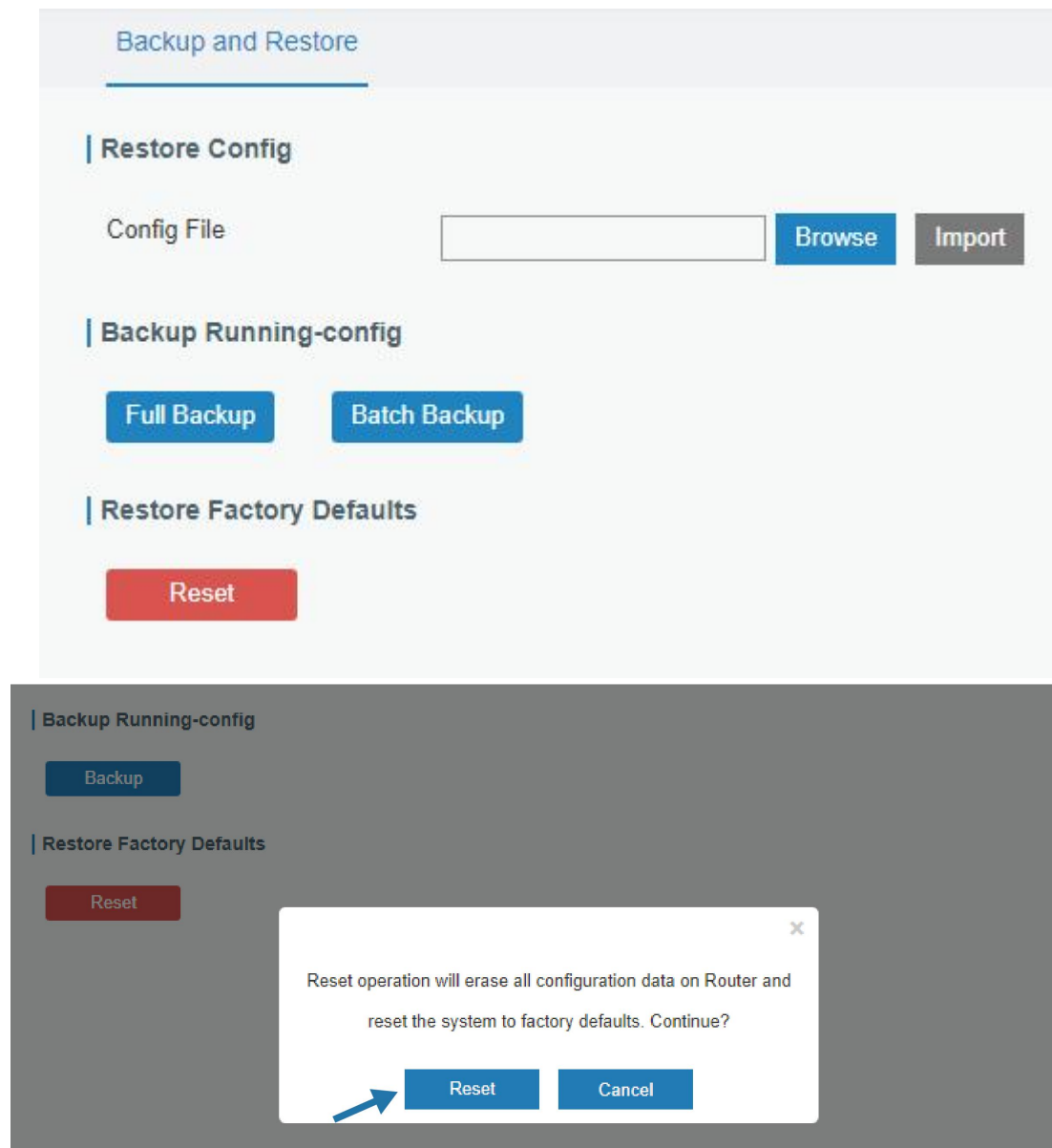

Then the gateway will reboot and restore to factory settings immediately.

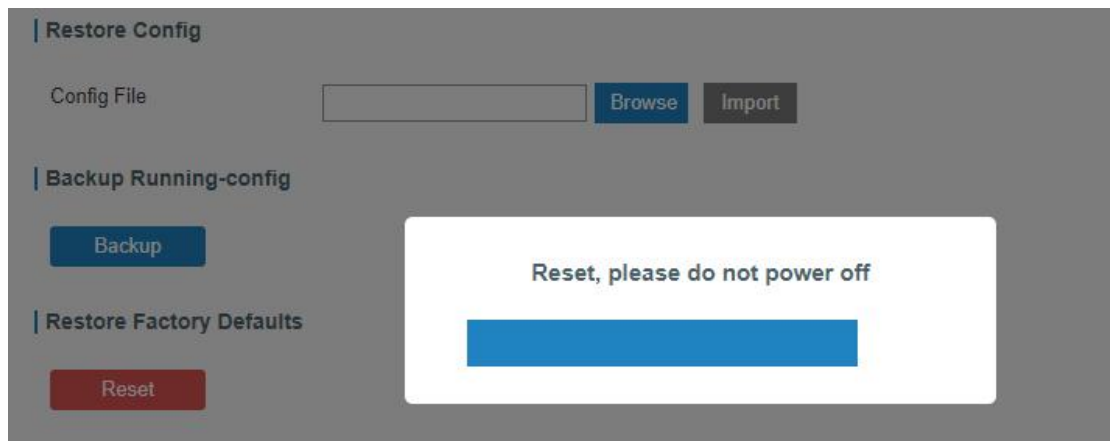

Please wait till SYS light staticly and the login page pops up again, which means the gateway has already been reset to factory defaults successfully.

Related Topic

[Restore Factory Defaults](#)

4.1.2 Via Hardware

Locate the reset button on the gateway, and take corresponding actions based on the status of SYS LED.

SYS LED	Action
Static Green	Press and hold the reset button for more than 5 seconds.
Static Green → Rapidly Blinking	Release the button and wait.
Off → Static Green	The gateway is now reset to factory defaults.

4.2 Firmware Upgrade

It is suggested that you contact Milesight technical support first before you upgrade gateway firmware. Gateway firmware file suffix is ".bin".

After getting firmware file please refer to the following steps to complete the upgrade.

1. Go to "Maintenance > Upgrade".
2. Click "Browse" and select the correct firmware file from the PC.
3. Click "Upgrade" and the gateway will check if the firmware file is correct. If it's correct, the firmware will be imported to the gateway, and then the gateway will start to upgrade.

Upgrade

Upgrade

Firmware Version 60.0.0.33

Reset Configuration to Factory Default

Upgrade Firmware

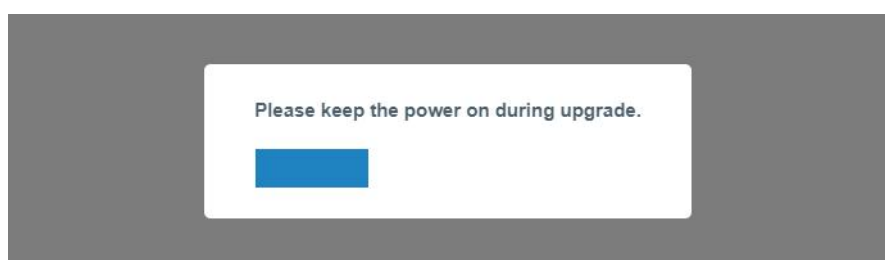

Related Topic

[Upgrade](#)

4.3 Ethernet Connection

1. Go to “Network > Interface > Port” page to select the connection type and configure Ethernet port configuration.
2. Click “Save & Apply” for configuration to take effect.

Port WLAN Cellular Loopback

— Port_1

Port	eth 0
Connection Type	Static IP
IP Address	192.168.22.112
Netmask	255.255.255.0
Gateway	192.168.22.1
MTU	1500
Primary DNS Server	8.8.8.8
Secondary DNS Server	114.114.114.114
Enable NAT	<input checked="" type="checkbox"/>

3. Connect Ethernet port of gateway to devices like router or modem.

4. Log in the web GUI via the newly assigned IP address and go to “Status -> Network” to check Ethernet port status.

Port	Status	Type	IP Address	Netmask	Gateway	DNS	Duration
eth 0	up	Static	192.168.22.112	255.255.255.0	192.168.22.1	8.8.8.8	1days_02h 34m 22s

Related Topic

[Port Setting](#)

4.4 Cellular Connection

1. Go to “Network > Interface > Cellular > Cellular Setting” and configure the cellular info.
2. Choose relevant network type.

Port	WLAN	Cellular	Loopback
Cellular Setting			
Enable		<input checked="" type="checkbox"/>	
Network Type		Auto	
APN			
Username			
Password			
Access Number			
PIN Code			
Authentication Type		Auto	
Roaming		<input checked="" type="checkbox"/>	
SMS Center			
Connection Setting		<input type="checkbox"/>	
Enable NAT		<input checked="" type="checkbox"/>	

Click “Save” and “Apply” for configuration to take effect.

3. Check the cellular connection status by WEB GUI of gateway.

Click “Status > Cellular” to view the status of the cellular connection. If it shows 'Connected', SIM has dialed up successfully.

Overview	Packet Forward	Cellular	Network	WLAN
Modem				
Status	Ready			
Model	EC25			
Version	EC25ECGAR06A07M1G			
Signal Level	23asu (-67dBm)			
Register Status	Registered (Home network)			
IMEI	860425047368939			
IMSI	460019425301842			
ICCID	89860117838009934120			
ISP	CHN-UNICOM			
Network Type	LTE			
PLMN ID				
LAC	5922			
Cell ID	340db83			
Network				
Status	Connected			
IP Address	10.132.132.59			
Netmask	255.255.255.240			
Gateway	10.132.132.60			

4. Check out if network works properly by browser on PC.

Open your preferred browser on PC, type any available web address into address bar and see if it is able to visit Internet via the UG67.

Related Topic

[Cellular Setting](#)

[Cellular Status](#)

4.5 Wi-Fi Application Example

4.5.1 AP Mode

Application Example

Configure UG67 as AP to allow connection from users or devices.

Configuration Steps

1. Go to "Network > Interface > WLAN" to configure wireless parameters as below.

Port	WLAN	Cellular	Loopback
WLAN			
Enable	<input checked="" type="checkbox"/>		
Work Mode	AP		
SSID Broadcast	<input checked="" type="checkbox"/>		
AP Isolation	<input type="checkbox"/>		
Radio Type	802.11n(2.4GHz)		
Channel	Auto		
SSID	Gateway_F1200F		
BSSID	24:e1:24:f1:20:0f		
Encryption Mode	No Encryption		
Bandwidth	20MHz		
Max Client Number	10		

Click “Save” and “Apply” buttons after all configurations are done.

2. Use a smart phone to connect the access point of gateway. Go to “Status > WLAN”, and you can check the AP settings and information of the connected client/user.

Overview	Packet Forward	Cellular	Network	WLAN	VPN
WLAN Status					
Wireless Status		Enabled			
MAC Address		24:e1:24:f1:20:0f			
Interface Type		AP			
SSID		Gateway_F1200F			
Channel		Auto			
Encryption Type		No Encryption			
Status		Up			
IP Address		192.168.1.1			
Netmask		255.255.255.0			
Connection Duration		0 days, 02:40:52			

4.5.2 Client Mode

Application Example

Configure UG67 as Wi-Fi client to connect to an access point to have Internet access.

Configuration Steps

1. Go to “Network > Interface > WLAN” and click “Scan” to search for WiFi access point.

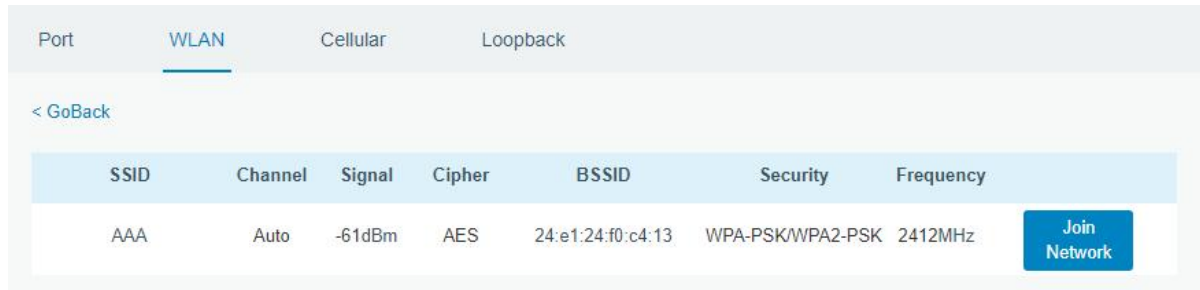

2. Select one access point and click “Join Network”, then type the password of the access point.

The screenshot shows the configuration page for the selected access point. The 'WLAN' section is expanded, showing various settings. The 'Work Mode' is set to 'Client', and the 'Scan' button is visible. The 'IP Setting' section is also visible, with the 'Protocol' set to 'DHCP Client'.

WLAN	Cellular	Loopback
<p>Enable <input checked="" type="checkbox"/></p> <p>Work Mode <input type="text" value="Client"/> <input type="button" value="Scan"/></p> <p>SSID <input type="text" value="AAA"/></p> <p>BSSID <input type="text" value="24:e1:24:f0:c4:13"/></p> <p>Encryption Mode <input type="text" value="WPA-PSK/WPA2-PSK"/></p> <p>Cipher <input type="text" value="AES"/></p> <p>Key <input type="text" value="....."/></p> <p>IP Setting</p> <p>Protocol <input type="text" value="DHCP Client"/></p>		

Click “Save” and “Apply” buttons after all configurations are done.

3. Go to “Status > WLAN”, and you can check the connection status of the client.

Overview	Packet Forward	Cellular	Network	WLAN
WLAN Status				
Wireless Status	Enabled			
MAC Address	24:e1:24:f0:de:14			
Interface Type	Client			
SSID	AAA			
Channel	Auto			
Encryption Type	WPA-PSK/WPA2-PSK			
Cipher	AES			
Status	Connected			
IP Address	192.168.1.145			
Netmask	255.255.255.0			
Connection Duration	0 days, 02:44:45			

Related Topic

[WLAN Setting](#)

[WLAN Status](#)

4.6 Packet Forwarder Configuration

UG67 gateway has installed multiple packet forwarders including Semtech, Basic station, Chirpstack-Generic MQTT broker, etc. Before connecting make sure the gateway has connected to network.

1. Go to "Packet Forwarder" > "General".

General	Radios	Advanced	Custom	Traffic	
General Setting					
Gateway EUI	24E124FFFEF12257				
Gateway ID	<input type="text" value="24E124FFFEF12257"/>				
Frequency-Sync	<input type="text" value="Disabled"/>				
Multi-Destination					
ID	Enable	Type	Server Address	Connect Status	Operation
0	Enabled	Embedded NS	localhost	Connected	

2. Click to add a new network server. Fill in the network server information and

enable this server.

Enable	<input checked="" type="checkbox"/>
Type	Semtech
Server Address	eu1.cloud.thethings.network
Port Up	1700
Port Down	1700

[Save](#)

3. Go to "Packet Forwarder -> Radio" page to configure antenna type, center frequency and channels. The channels of the gateway and network server need to be the same.

Region: US915

Name	Center Frequency/MHz
Radio 0	904.3
Radio 1	905.0

Multi Channels Setting

Enable	Index	Radio	Frequency/MHz
<input checked="" type="checkbox"/>	0	Radio 0	903.9
<input checked="" type="checkbox"/>	1	Radio 0	904.1
<input checked="" type="checkbox"/>	2	Radio 0	904.3
<input checked="" type="checkbox"/>	3	Radio 0	904.5
<input checked="" type="checkbox"/>	4	Radio 1	904.7
<input checked="" type="checkbox"/>	5	Radio 1	904.9
<input checked="" type="checkbox"/>	6	Radio 1	905.1
<input checked="" type="checkbox"/>	7	Radio 1	905.3

4. Add the gateway on network server page. For more details about the network server connection please refer to [Milesight IoT Support portal](#).

5. Go to "Traffic" page to view the data communication of UG67.

General Radios Advanced Custom Traffic

Traffic Setting

[Stop](#) [Clear](#)

Rfch	Direction	Time	Ticks	Frequency	Datarate	Coderate	RSSI	SNR
0	up	05:57:30	212136749 3	903.9	SF10BW125	4/5	-51	13.2
0	up	05:57:29	211944923 1	904.5	SF7BW125	4/5	-95	8.5
0	up	05:57:13	210431205 7	904.6	SF8BW500	4/5	-51	11.5
0	up	05:57:06	209699855 6	903.9	SF7BW125	4/5	-65	14.2

4.7 Connect UG67 to Milesight IoT Cloud

1. Go to “Packet Forwarder->General” page to enable the embedded network server.

General Radios Advanced Custom Traffic

Packet Forwarder

Network Server

Network

System

Maintenance

APP

General Setting

Gateway EUI 24E124FFFEF12257

Gateway ID 24E124FFFEF12257

Frequency-Sync Disabled

Multi-Destination

ID	Enable	Type	Server Address	Connect Status	Operation
0	Enabled	Embedded NS	localhost	Connected	

2. Go to “Packet Forwarder-> Radio” page to select the antenna type, center frequency and channels. The channels of the gateway and nodes need to be the same.

Region US915

Name	Center Frequency/MHz
Radio 0	904.3
Radio 1	905.0

Multi Channels Setting

Enable	Index	Radio	Frequency/MHz
<input checked="" type="checkbox"/>	0	Radio 0	903.9
<input checked="" type="checkbox"/>	1	Radio 0	904.1
<input checked="" type="checkbox"/>	2	Radio 0	904.3
<input checked="" type="checkbox"/>	3	Radio 0	904.5
<input checked="" type="checkbox"/>	4	Radio 1	904.7
<input checked="" type="checkbox"/>	5	Radio 1	904.9
<input checked="" type="checkbox"/>	6	Radio 1	905.1
<input checked="" type="checkbox"/>	7	Radio 1	905.3

3. Go to “Network Server” → “General” page to enable the network server and “Cloud mode”, then select “Milesight IoT Cloud” mode.

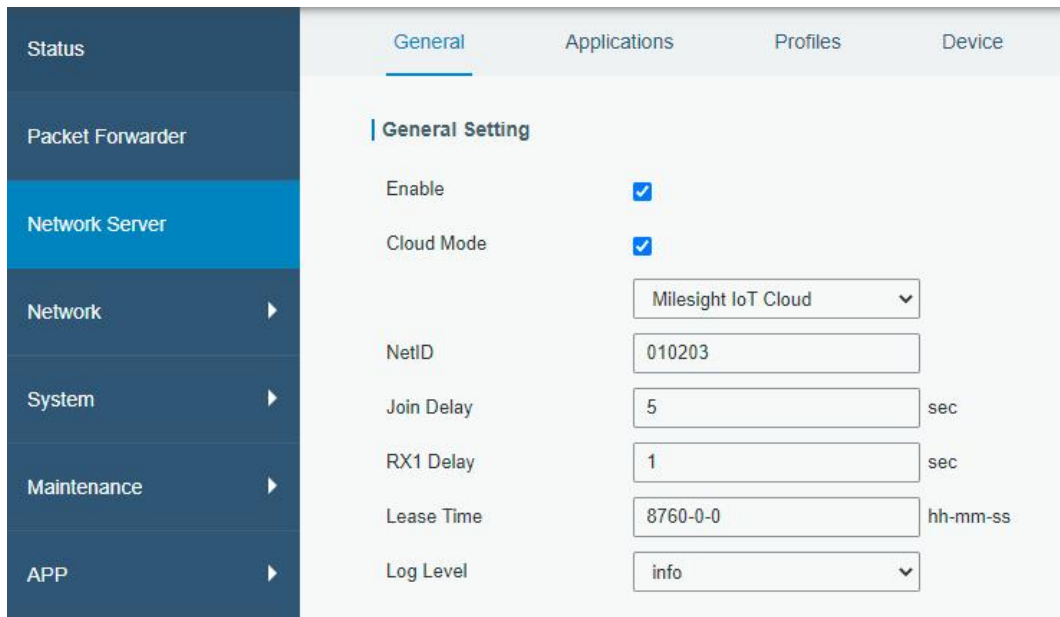

4. Log in the Milesight IoT Cloud. Then go to “My Devices” page and click “+New Devices” to add gateway to Milesight IoT Cloud via SN. Gateway will be added under “Gateways” menu.

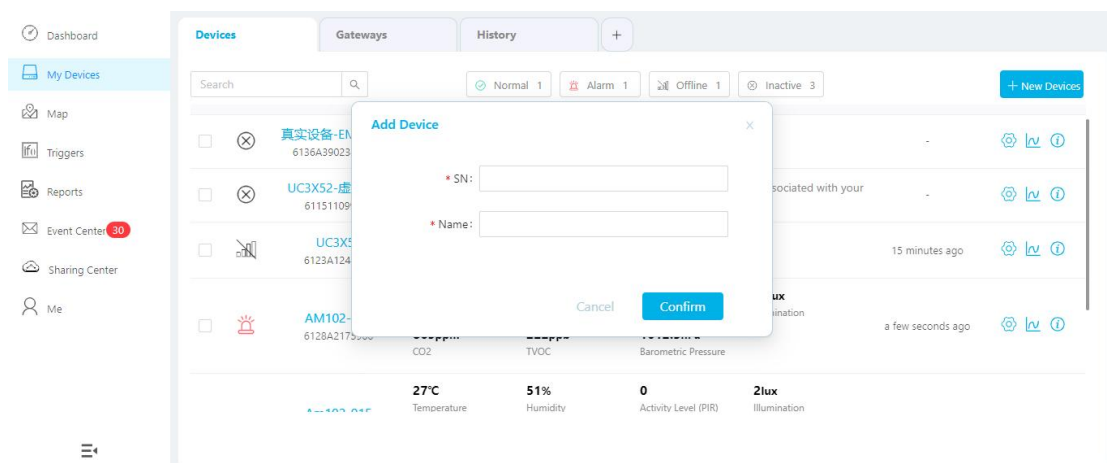

5. The gateway is online on Milesight IoT Cloud.

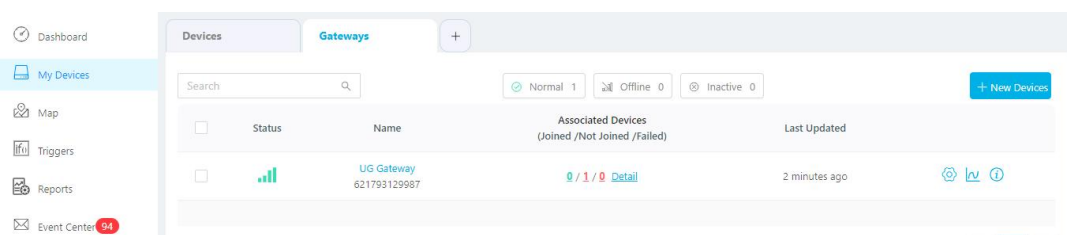

4.8 Application Configuration

You can create a new application on this page, which is mainly used to define the method of decoding the data sent from end-device and choosing the data transport protocol to send data to another server address. The data will be sent to your custom server address using MQTT, HTTP or HTTPS protocol.

1. Go to “Network Server” > “Application”.

2. Click  to enter the configuration page, displayed as the following picture:

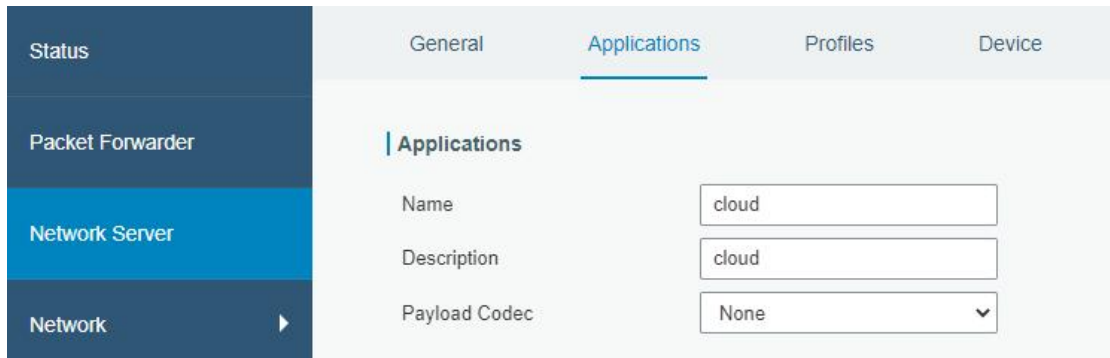

	General	Applications	Profiles	Device
Status				
Packet Forwarder				
Network Server				
Network				
	Applications			
	Name	cloud		
	Description	cloud		
	Payload Codec	None		

3. Click “Save” to create this application.

4. Click  to add a data transmission type.

HTTP or HTTPS:

Step 1: select HTTP or HTTPS as transmission protocol.

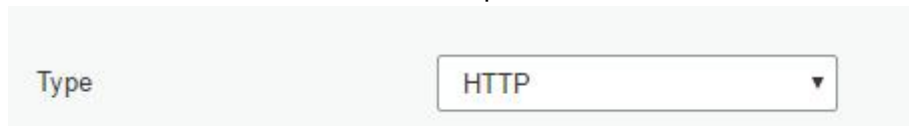

Type

Step 2: Enter the destination URL. Different types of data can be sent to different URLs.

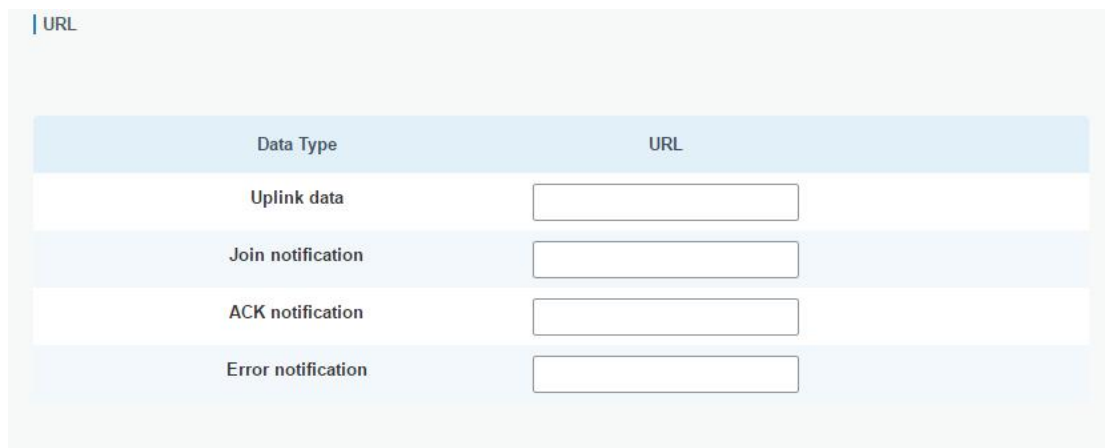

Data Type	URL
Uplink data	<input type="text"/>
Join notification	<input type="text"/>
ACK notification	<input type="text"/>
Error notification	<input type="text"/>

Enter the header name and header value if there is user credentials when accessing the HTTP(s) server.



Header Name	Header Value	Operation
<input type="text"/>	<input type="text"/>	

MQTT:

Step 1: select the transmission protocol as MQTT.

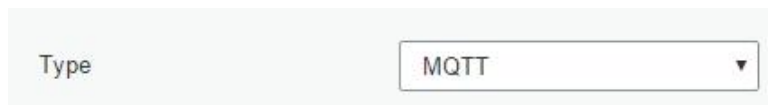

A form element showing a label 'Type' followed by a dropdown menu. The dropdown menu is currently set to 'MQTT' and has a downward-pointing arrow on the right side.

Step 2: Fill in MQTT broker general settings.

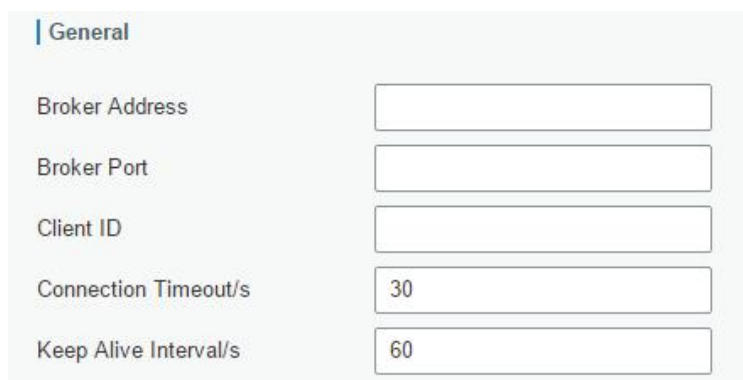

A form titled 'General' with the following fields:

Broker Address	<input type="text"/>
Broker Port	<input type="text"/>
Client ID	<input type="text"/>
Connection Timeout/s	<input type="text" value="30"/>
Keep Alive Interval/s	<input type="text" value="60"/>

Step 3: Select the authentication method required by the server.

If you select user credentials for authentication, you need to enter the username and password for authentication.



A form titled 'User Credentials' with the following fields:

Enable	<input checked="" type="checkbox"/>
Username	<input type="text"/>
Password	<input type="password"/>

If certificate is necessary for verification, please select mode and import CA certificate, client certificate and client key file for authentication.

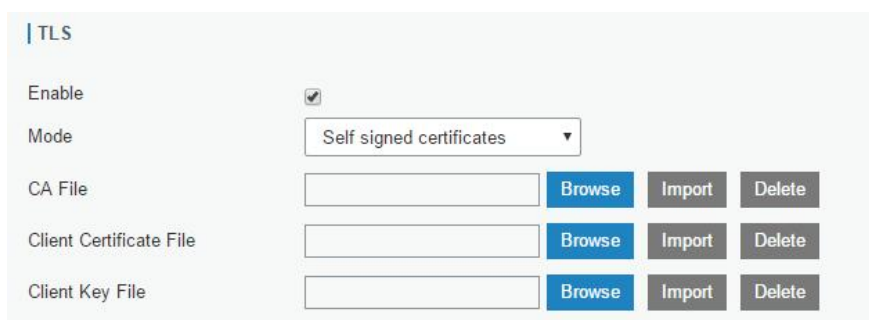

A form titled 'TLS' with the following fields:

Enable	<input checked="" type="checkbox"/>
Mode	<input type="text" value="Self signed certificates"/>
CA File	<input type="text"/> <input type="button" value="Browse"/> <input type="button" value="Import"/> <input type="button" value="Delete"/>
Client Certificate File	<input type="text"/> <input type="button" value="Browse"/> <input type="button" value="Import"/> <input type="button" value="Delete"/>
Client Key File	<input type="text"/> <input type="button" value="Browse"/> <input type="button" value="Import"/> <input type="button" value="Delete"/>

Step 4: Enter the topic to receive data and choose the QoS.

Data Type	topic	
Uplink data	devices/UR67/messages/event	QoS 0
Downlink data		QoS 0
Multicast downlink data		QoS 0
Join notification		QoS 0
ACK notification		QoS 0
Error notification		QoS 0

4.9 Device Configuration

Go to “Device” page and click “Add” to add LoRaWAN® node devices. Please select correct device profile according to device type.

General Applications Profiles **Device** Gateways Packets

Device

Add Bulk Import Delete All

Device Name	Device EUI	Device-Profile	Application	Last Seen	Activated	Operation
No matching records found						

Device Name	<input type="text" value="lora-sensor"/>
Description	<input type="text" value="a short description of your node"/>
Device EUI	<input type="text" value="0000000000000000"/>
Device-Profile	<input type="text" value="OTAA-ClassC"/>
Application	<input type="text"/>
Frame-counter Validation	<input type="checkbox"/>
Application Key	<input type="text"/>
Device Address	<input type="text"/>
Network Session Key	<input type="text"/>
Application Session Key	<input type="text"/>
Uplink Frame-counter	<input type="text" value="0"/>
Downlink Frame-counter	<input type="text" value="0"/>

Save & Apply

You can also click “Bulk Import” if you want to add many nodes all at once.

Click “Template Download” to download template file and add device information to this file. Application and device profile should be the same as you created on web page.

	A	B	C	D	E	F	G	H	I
1	name	description	deveui	application	deviceprofile	appkey	devaddr	appskey	nrkskey
2	24e1242191323266		24e1242191323266	cloud	ClassC-OTAA	112233445566778899aa112233445566			
3									
4									
5									

Import this file to add bulks of devices.

4.10 Send Data to Device

1. Go to “Network Server” > “Packets”, check the packet in the network server list to make sure that the device has joined the network successful.

1122612191	868100000	SF7BW125	-	-	17	0	JnAcc	2019-08-06T09:22:29+08:00	
112261219	868100000	SF7BW125	9.5	-77	18	0	JnReq	2019-08-06T09:22:29+08:00	

2. Fill in the device EUI or select the multicast group which you need to send downlinks. Then fill in the downlink commands, ports.

3. Click “Send”.



4. Check the packet in the network server list to make sure that the device has received this message successful. It’s suggested to enable “Confirmed”. Multicast feature does not support confirmed downlinks.

You can click “Refresh” to refresh the list or set automatic refreshing frequency for the list. **If the device’s class type is Class C, then the device will constantly receive packets.**

This packet’s type is DnCnf (Downlink Confirmed Packet) and if the packet’s color is gray, then it means the packet cannot be transmitted now because at least one message has been in the queue. If the packet record is white, it means the packet has been delivered successfully.

1122612191311123	869525000	SF12BW125	-	-	6	2	DnCnf	2019-08-06T09:22:55+08:00	Success
1122612191311123	0				6	2	DnCnf		Pending

If the device receives this downlink confirmed packet, then the device will reply "ACK" when delivering next.

Device EUI	Frequency	Datarate	SNR	RSSI	Size	Fcnt	Type	Time	Details
1122612191311123	868300000	SF10BW125	-	-	0	3	DnUnc	2019-08-06T09:23:44+08:00	!
1122612191311123	868300000	SF10BW125	10.5	-75	64	2	UpCnf	2019-08-06T09:23:44+08:00	!
1122612191311123	869525000	SF12BW125	-	-	6	2	DnCnf	2019-08-06T09:22:55+08:00	!
1122612191311123	0				6	2	DnCnf		!
1122612191311123	868500000	SF10BW125	-	-	0	1	DnUnc	2019-08-06T09:22:49+08:00	!

Packets Details

Dev Addr	07e7
GwEUI	24e124ff
AppEUI	557240
DevEUI	1122612191311123
Immediately	-
Timestamp	874346044
Type	UpCnf
Adr	false
AdrAckReq	false
Ack	true
Fcnt	21
Fport	55
Modulation	LORA

Ack is "true" means that the device has received this packet.

If the device's class type is Class A, only after the device sends out an uplink packet will the network server sends out data to the device.

Device EUI	Frequency	Datarate	SNR	RSSI	Size	Fcnt	Type	Time	Details
1122612191311123	868300000	SF10BW125	-	-	0	19	DnUnc	2019-08-06T09:49:38+08:00	!
1122612191311123	868300000	SF10BW125	10.8	-76	64	21	ACK	2019-08-06T09:49:38+08:00	!
1122612191311123	868300000	SF10BW125	10.8	-76	64	21	UpCnf	2019-08-06T09:49:38+08:00	!
1122612191311123	868100000	SF10BW125	-	-	6	18	DnCnf	2019-08-06T09:48:43+08:00	Success
1122612191311123	868100000	SF10BW125	9.8	-77	64	20	UpCnf	2019-08-06T09:48:43+08:00	!
1122612191311123	0				6	18	DnCnf		Pending
1122612191311123	868500000	SF10BW125	-	-	0	17	DnUnc	2019-08-06T09:47:38+08:00	!
1122612191311123	868500000	SF10BW125	8.0	-76	64	19	UpCnf	2019-08-06T09:47:38+08:00	!
1122612191311123	868100000	SF10BW125	-	-	0	16	DnUnc	2019-08-06T09:46:38+08:00	!
1122612191311123	868100000	SF10BW125	11.2	-74	64	18	UpCnf	2019-08-06T09:46:37+08:00	!

Manual Refresh

Refresh

Show the signal-noise ratio.

RSSI
Show the received signal strength indicator.

Size
Show the size of packet.

Fcnt
Show the frame counter.

Type
Show the type of the packet:
JnAcc - Join Accept Packet
JnReq - Join Request Packet
UpUnc - Uplink Unconfirmed Packet
UpCnf - Uplink Confirmed Packet - ACK response from network requested
DnUnc - Downlink Unconfirmed Packet
DnCnf - Downlink Confirmed Packet - ACK response from end-device requested

Time
Show the time of packet was sent or received.

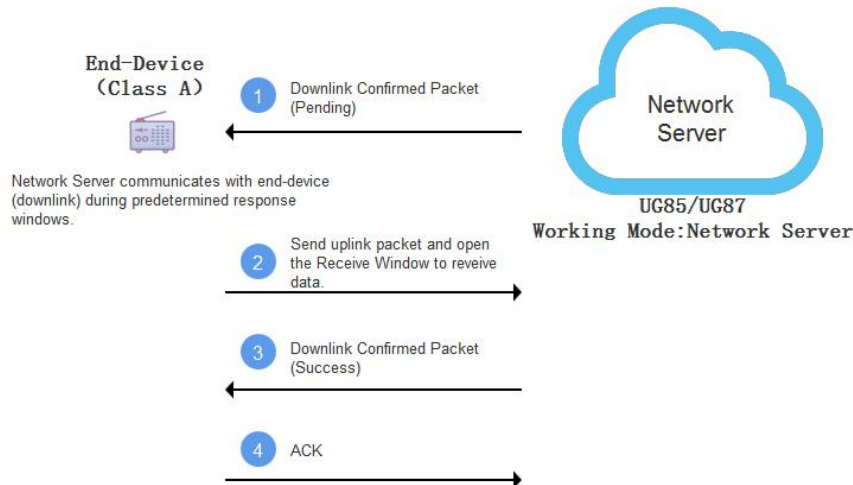

Network Server

Clear

Device EUI	Frequency	Datarate	SNR	RSSI	Size	Fcnt	Type	Time	Details
1122612191311123	868300000	SF10BW125	-	-	0	19	DnUnc	2019-08-06T09:49:38+08:00	!
1122612191311123	868300000	SF10BW125	10.8	-76	64	21	ACK	2019-08-06T09:49:38+08:00	!
1122612191311123	868300000	SF10BW125	10.8	-76	64	20	UpCnf	2019-08-06T09:49:38+08:00	!
1122612191311123	868100000	SF10BW125	-	-	6	18	DnCnf	2019-08-06T09:48:43+08:00	!
1122612191311123	868100000	SF10BW125	9.8	-77	64	20	UpCnf	2019-08-06T09:48:43+08:00	!
1122612191311123	0				6	18	DnCnf		!
1122612191311123	868500000	SF10BW125	-	-	0	17	DnUnc	2019-08-06T09:47:38+08:00	!
1122612191311123	868500000	SF10BW125	8.0	-76	64	19	UpCnf	2019-08-06T09:47:38+08:00	!
1122612191311123	868100000	SF10BW125	-	-	0	16	DnUnc	2019-08-06T09:46:38+08:00	!
1122612191311123	868100000	SF10BW125	11.2	-74	64	18	UpCnf	2019-08-06T09:46:37+08:00	!

Showing 51 to 60 of 355 rows rows per page

means the device has received the packet you send.

Related Topic

[Packets](#)

4.11 Node-RED

4.11.1 Start the Node-RED

1. Go to "App > Node-RED" to enable the Node-RED feature.
2. After enabled, click "Launch" to go to the Node-RED web GUI and to log in with the same username and password as gateway.

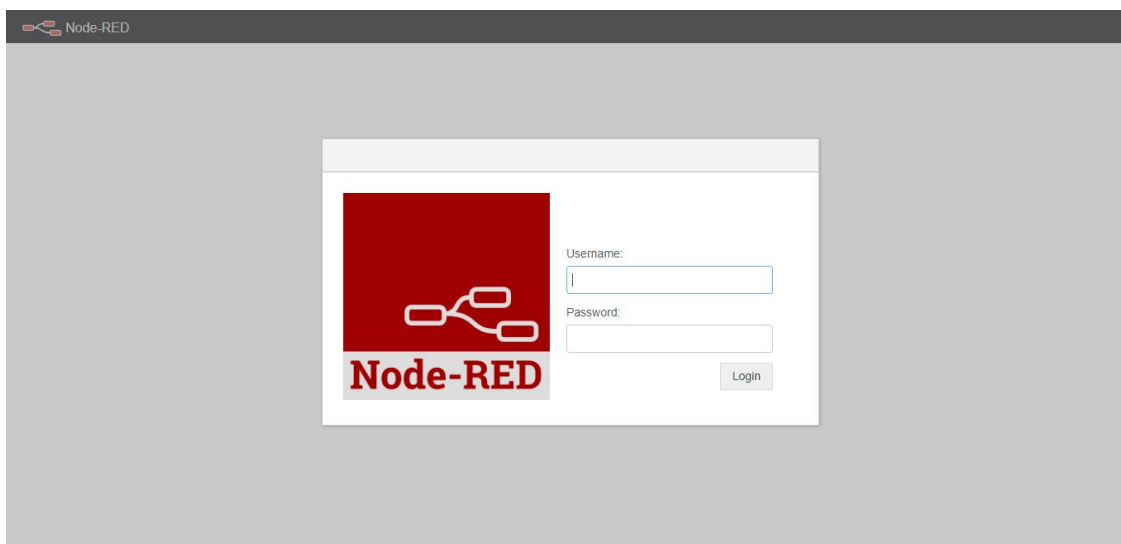

4.11.2 Send Data by Email

Application Example

Send AM104 device data by Email.



Configuration Steps

1. Add a "LoRa Input" node. Before adding please ensure network server mode is enabled and LoRaWAN devices have joined the network.
2. If you add many devices and only need one device data, add "Device Filter" node behind the "LoRa Input" and type the device EUI.

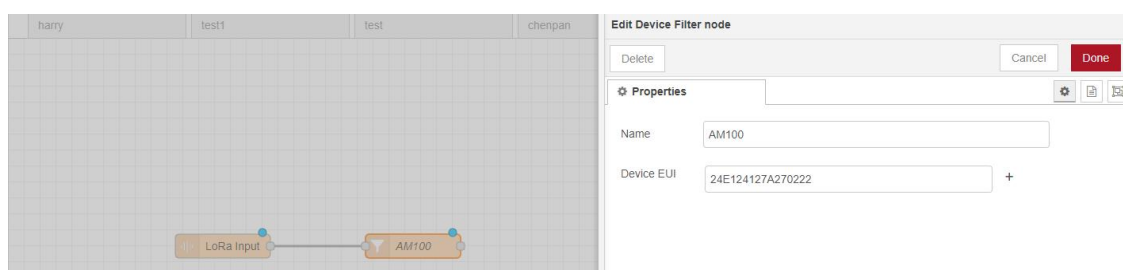

3. Add a "Decoder" node to decode the Milesight sensor data.

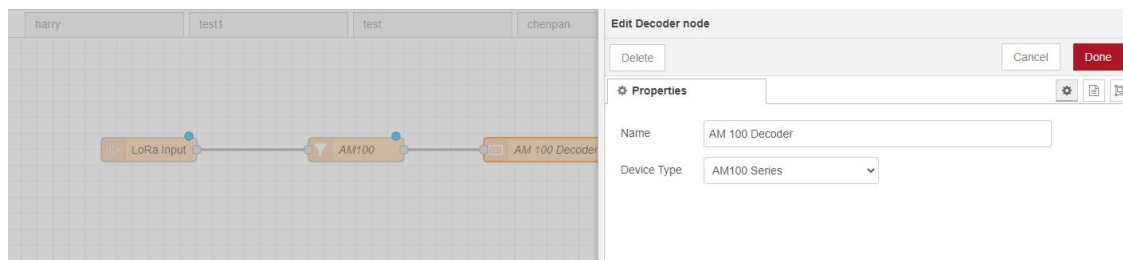

4. Add an “Email Output” and type the SMTP client settings, destination email address and contents. Example content:

The time is {{time}}

Deveui is {{deveui}}

Humidity is {{payload.humidity}}

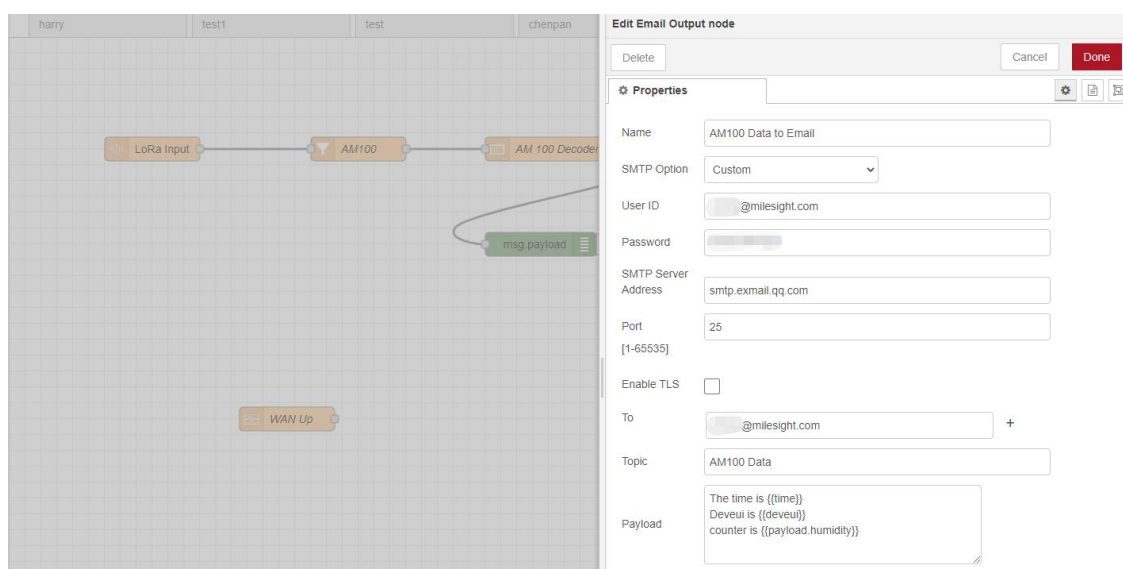

Note:

- 1) When you select SMTP Option as “Same as Gateway”, go to “System -> General Settings -> SMTP” to configure the SMTP clients.
- 2) Basic format to call LoRaWAN node data is `{{property name}}`, you can click “Help” page for more info about the Email or SMS payload format.
- 3) If you need to check the output content in every node, please add debug node.
5. After completing the configuration, click “Deploy” to save all your configuration.

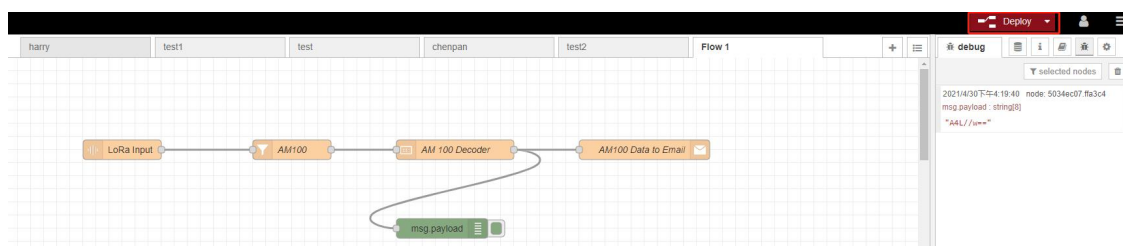

6. When AM104 sends data to gateway, gateway will transfer the data to email.

AM100 Data ★

2021-04

From [redacted]@milesight.com>

To [redacted]@milesight.com>

Time: 2021年4月30日 (周五) 17:13 🕒

Size: 2 KB

The time is 2021-04-30T09:13:13.872942Z Devei is 24e124127a270222 Temperature is 30.4 Humidity is 52

Related Topic[Node-RED](#)**[END]**