



ADT209/210 Loop Calibrator



ADT209/210 Loop Calibrator

User Manual

(Version number: 1609V02)



Additel Corporation.

Statement

This manual is applicable to the ADT209/210 loop calibrator designed and produced by the Additel Corporation. This manual is written in English. If there are any discrepancy in the content of different language versions, the English version shall prevail. This manual subject to change without prior notice.

CONTENTS

| | |
|--|-----------|
| 1. Warning Notice | 1 |
| 2. Product Description | 1 |
| 3. Basic Structure | 2 |
| 4. Keypad function | 3 |
| 5. Display | 4 |
| 6. Boot display | 5 |
| 7. Main Function Operation | 6 |
| 7.1 Measurement/Output Switch..... | 6 |
| 7.2 Backlight Brightness Adjustment..... | 6 |
| 7.3 Keypad Lock..... | 6 |
| 7.4 Voltage Measurement..... | 6 |
| 7.5 Current Output/Simulate Transmitter Output..... | 8 |
| 7.5.1 Range Switching..... | 9 |
| 7.5.2 Function Selection..... | 9 |
| 7.5.3 Output Value Adjustment..... | 9 |
| 7.5.4 Automatic Ramp/step Output..... | 10 |
| 7.6 Current Measurement/Loop Transmitter mA Measurement..... | 10 |
| 7.6.1 Range Switching..... | 10 |
| 7.6.2 Function Selection..... | 11 |
| 8. Menu Operation | 12 |
| 8.1 Menu Structure..... | 12 |
| 8.2 Menu Operation..... | 13 |

| | |
|--|-----------|
| 8.2.1 Enter/Return To Menu | 13 |
| 8.2.2 Switch Menu Items | 13 |
| 8.2.3 Modify Setting Menu Parameter | 13 |
| 8.2.3 Data Entry | 13 |
| 8.3 Auto Shutdown Setting | 13 |
| 8.4 Automatic Shutdown Backlight Setting | 13 |
| 8.5 Measurement Filter Parameter Setting | 14 |
| 8.6 Automatic Ramp/Step Output Setting | 14 |
| 8.6.1 Ramp/Step Switch | 14 |
| 8.6.2 Direction Setting | 14 |
| 8.6.3 Ramp/Step Time Setting | 14 |
| 8.7 Clear Menu Setting | 15 |
| 8.8 Software/hardware Version | 15 |
| 8.9 Self-test | 15 |
| 8.9.1 Self-test Description | 15 |
| 8.9.2 Self-test Item Switch | 15 |
| 8.9.3 Self-test Item Description | 16 |
| 8.10 Calibration | 18 |
| 8.10.1 Calibration Condition | 18 |
| 8.10.2 Calibration Item | 18 |
| 8.10.3 Calibration Process | 18 |
| 8.10.4 Restore Factory Calibration Data | 19 |
| 9 Specification | 19 |
| 9.1 Main Specification | 19 |

| | |
|---|-----------|
| 9.1.1 DC Voltage Measurement..... | 19 |
| 9.1.2 DC mA Measurement/Loop Transmitter Current Measurement..... | 19 |
| 9.1.3 Source/sink DC Current Output..... | 20 |
| 9.1.4 Mechanical/live Switch Measurement..... | 20 |
| 9.2 General Specifications..... | 20 |
| 10. Replace The Battery..... | 22 |
| 11. Manufacturer Information..... | 23 |

I. Warning Notice

- ◆ Before using this instrument, please make sure you have read and understand the user manual.
- ◆ Inspect the calibrator for any damages before use.
- ◆ Do not apply more than 30V between any two terminals or between any terminal and ground.
- ◆ When using the calibrator to measure or output the correct wiring, mode and range must be used.
- ◆ To avoid any potential damage to other devices when testing, please adjust the calibrator to the correct mode before connecting the test leads.
- ◆ Replace the batteries as soon as the battery symbol flashes.
- ◆ Before removing the battery door, remove all test leads from the calibrator.

2. Product Description

ADT209/210 is a multi-function, durable, hand-held loop calibrator. This calibrator offers six primary functions: current output, analog transmitter output, voltage measurement, switch measurement, transmitter loop measurement, and current measurement. Each unit comes in a compact, ergonomic design such that the calibrator can be operated easily with one hand. The large, high contrast VA screen clearly displays the results. Each unit comes standard with an IP54 rating.

The ADT209 provides 0.03%RD accuracy, while the ADT210 provides higher accuracy as 0.01%RD.

3. Basic Structure

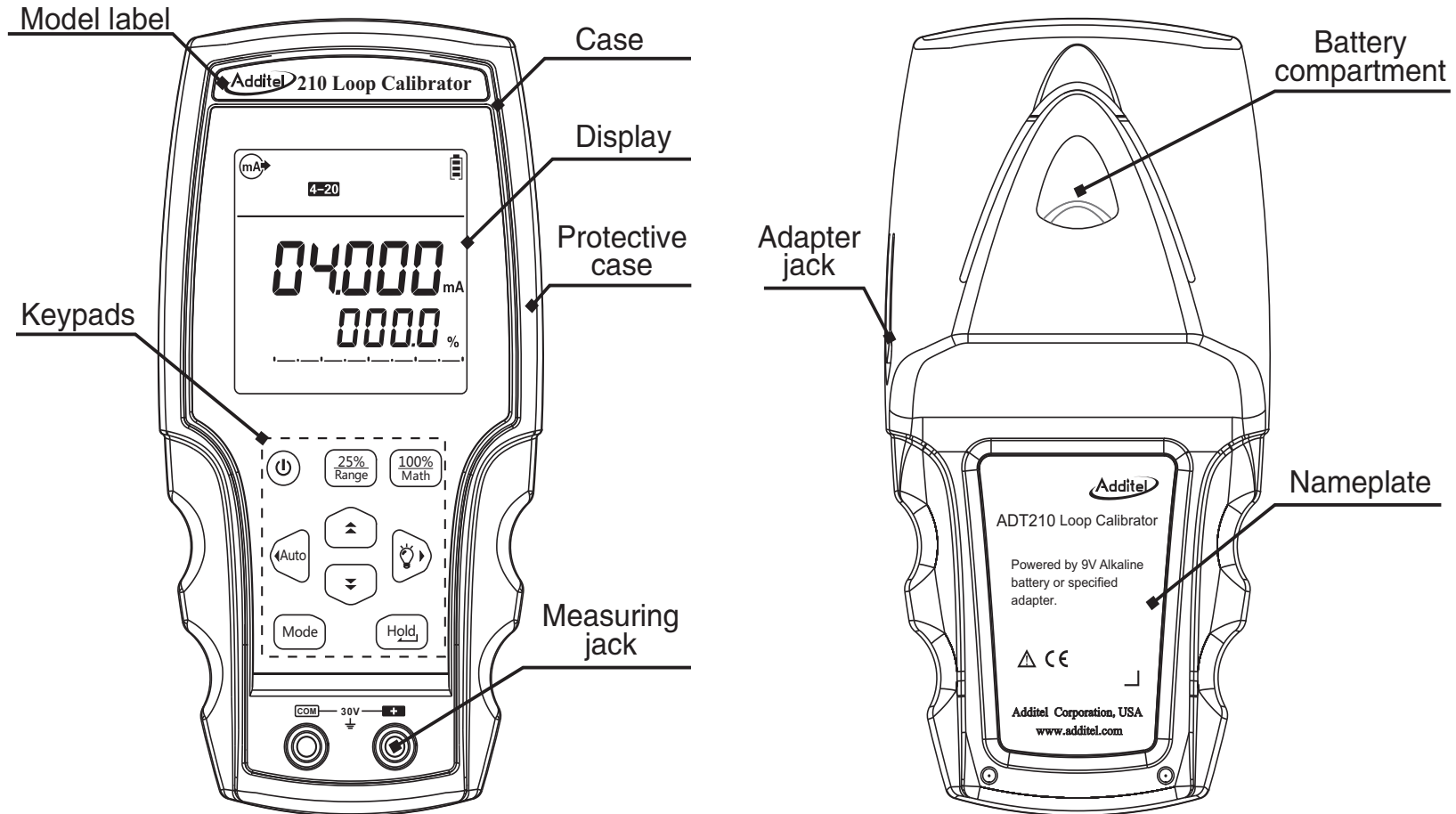

4. Keypad function

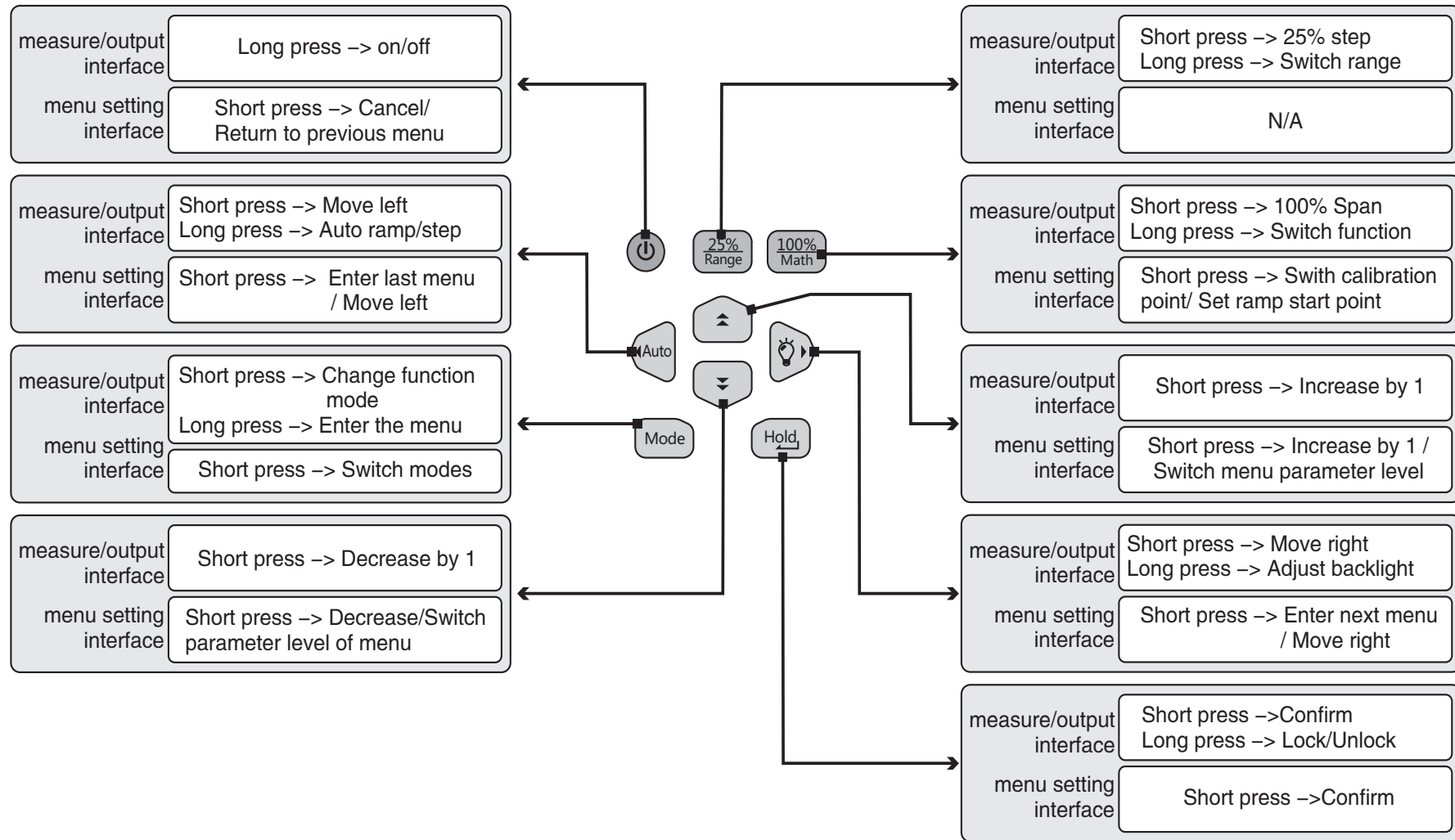

5. Display

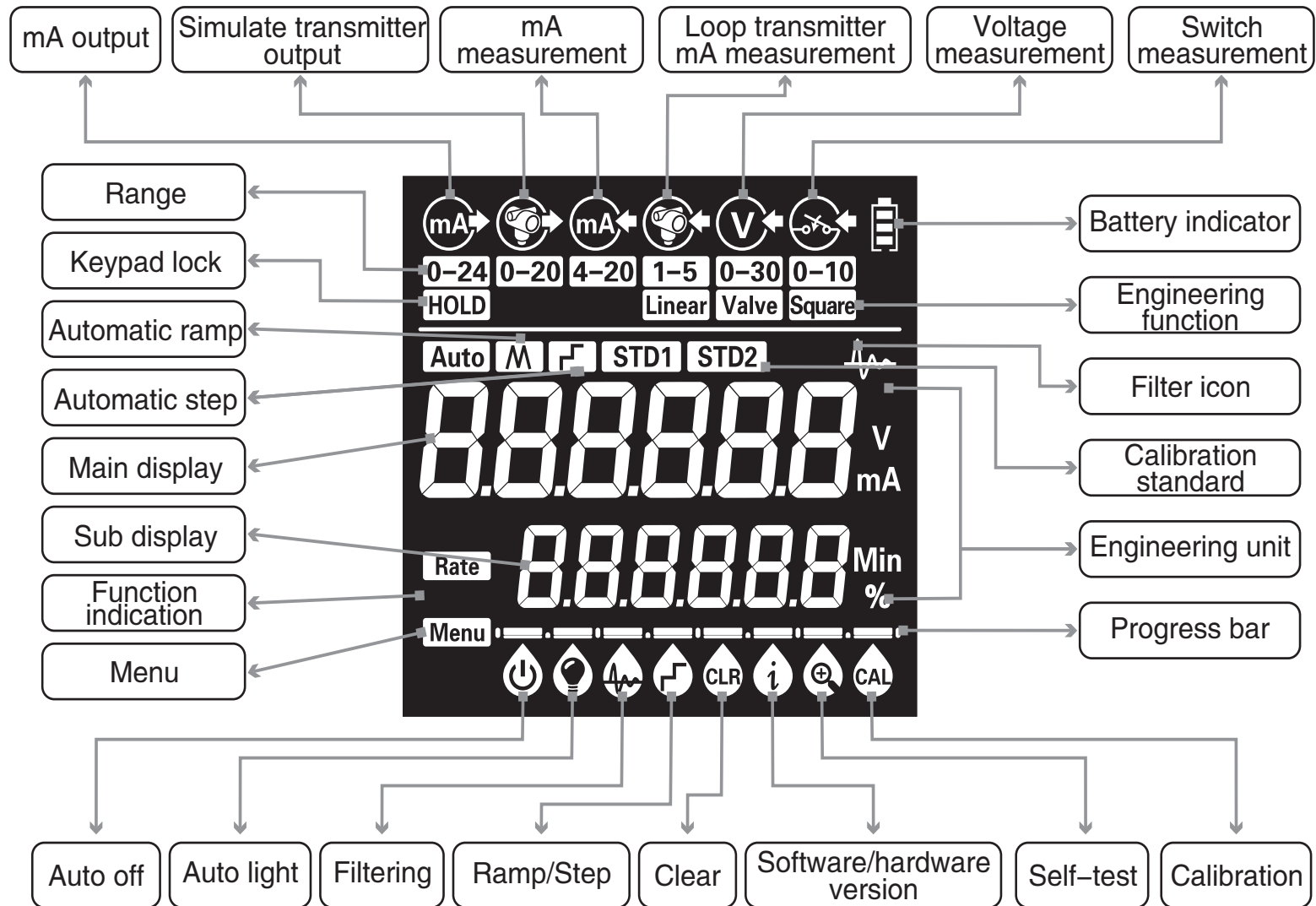

6. Boot display

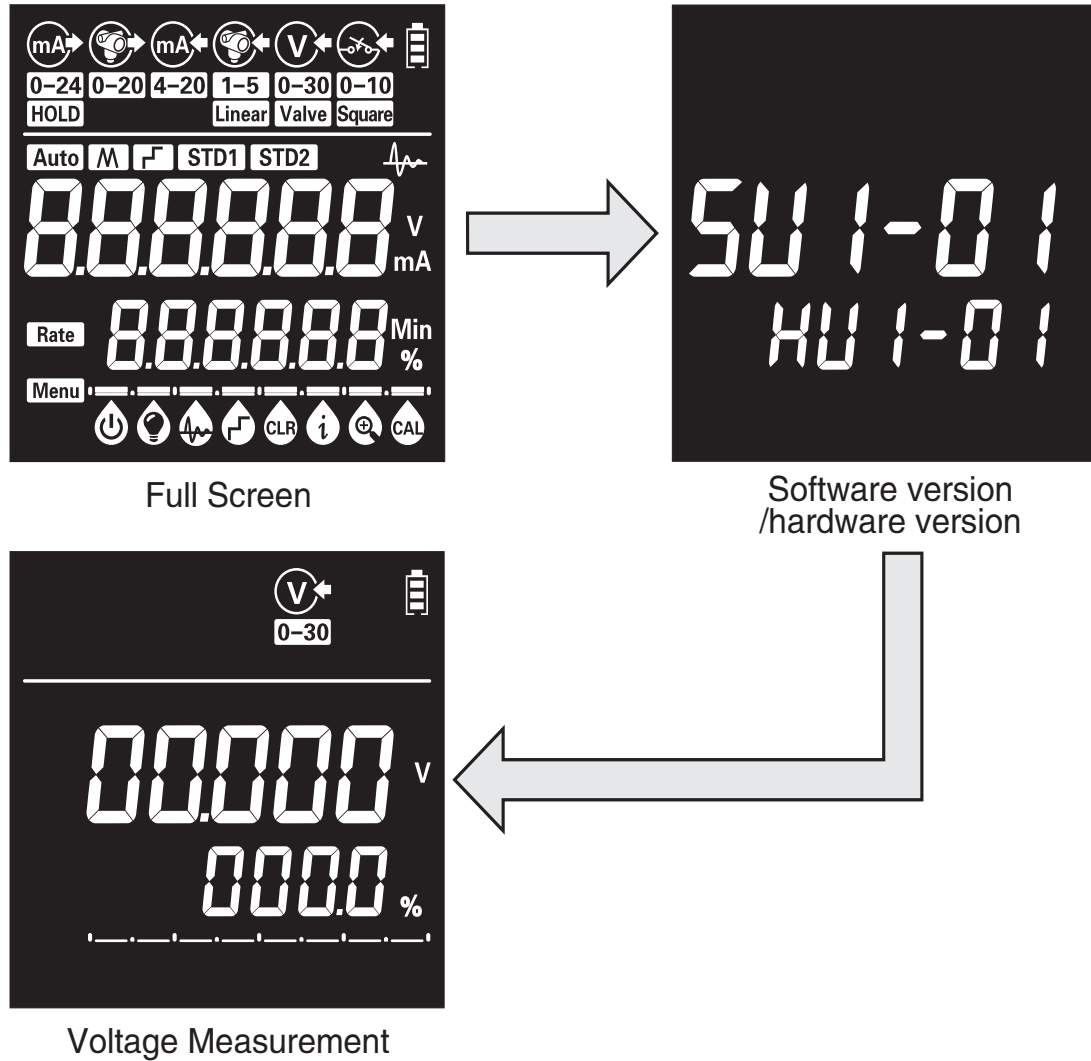

7. Main Function Operation

7.1 Measurement/Output Switch

ADT209 and ADT210 provide the following functions:

- ◆ Voltage Measurement
- ◆ Switch measure
- ◆ Current output
- ◆ Simulate transmitter output
- ◆ Current measurement
- ◆ Loop transmitter current measurement

In the measurement/output interface, you can press  to switch through above functions.

7.2 Backlight Brightness Adjustment

In any non-input screen, you can press and hold  to adjust backlight brightness(3-level brightness adjustment).

7.3 Keypad lock

In the measurement/output interface, you can press and hold  to lock/unlock the keypad.

7.4 Voltage Measurement

Voltage measurement interface can simultaneously display **voltage measurement value and percentage of range**, you can press and hold  to switch the current range, the voltage measurement has 3 ranges:

- ◆ 0 ~ 30V (0% ~ 100%) [default]
- ◆ 1V ~ 5V (0% ~ 100%)
- ◆ 0 ~ 10V (0% ~ 100%)

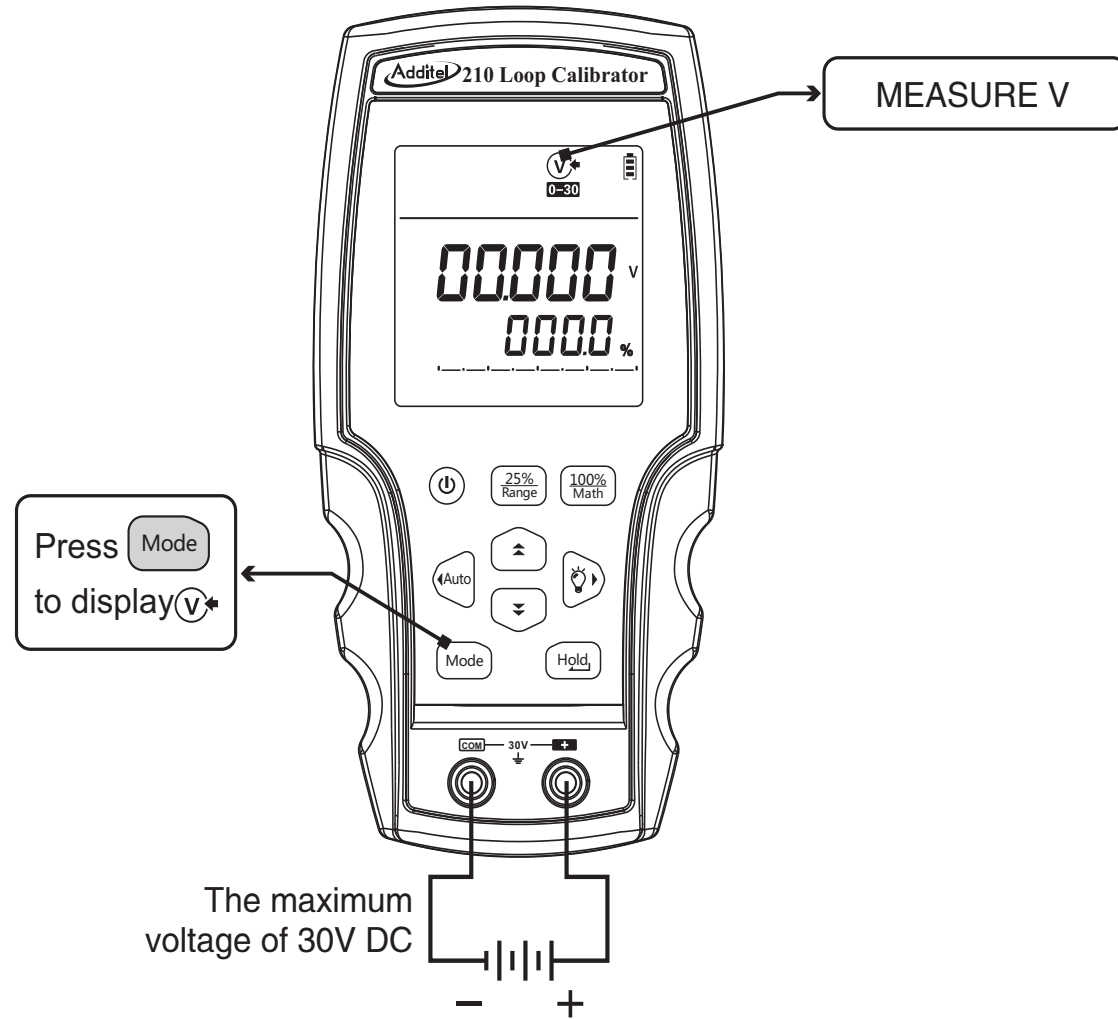

Fig 7.1 Voltage Measurement

7.5 Current Output/Simulate Transmitter Output

In current output mode (As Fig 7.2) , the calibrator supplies DC current with loop power. In simulate transmitter mode (As Fig 7.3) , the calibrator simulates a two-wire transmitter that has external power supply.

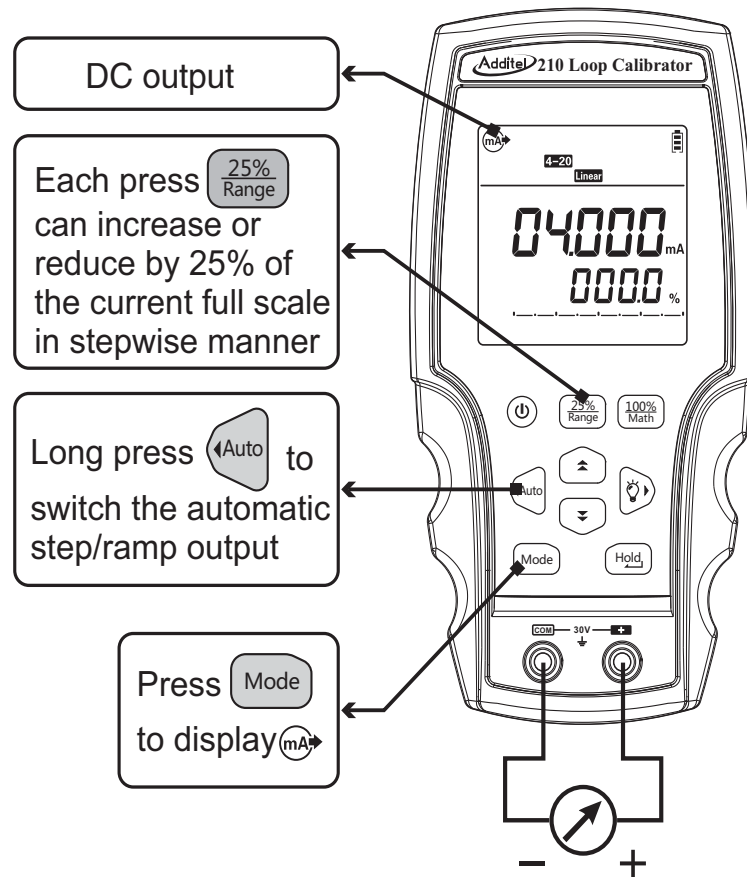

Fig 7.2 Current Output

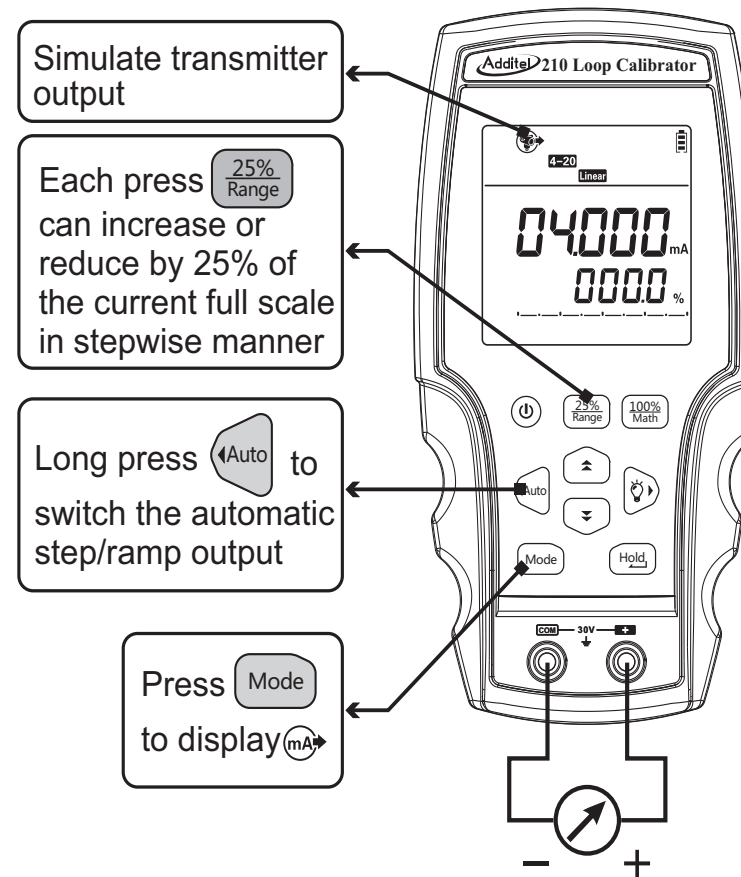



Fig 7.3 Simulate Transmitter Output



7.5.1 Range Switching

In the **current output/simulate transmitter output** interface, you can press and hold  key to switch the current range. **Current output/simulate transmitter output** has 3 ranges:





- ■ ◆ 4 ~ 20mA (0% ~ 100%) [default]
- ■ ◆ 0 ~ 20mA (0% ~ 100%)
- ■ ◆ 0 ~ 24mA (0% ~ 100%)







7.5.2 Function Selection

In the **current output/simulate transmitter output** interface, you can long press  to switch the percentage calculation. **Current output/simulate transmitter output** provides three calculation functions:

- ■ ◆ Linear, [default] 
- ■ ◆ Square 
- ■ ◆ Valve 

7.5.3 Output Value Adjustment

In the **current output/simulate transmitter output** interface, you can press  to adjust the output value by 25% of current range. You can press  key to output 0% and 100% of full scale. Press  key or  key to adjust by an integer by 1mA.

You can press  key or  key, the cursor will blink in the main display. Press  or  to adjust the position of the cursor. Press  or  to increase or decrease the value.

7.5.4 Automatic Ramp/Step Output

In the **current output/simulate transmitter output** function, you can press and hold key to select **auto ramp/automatic step** output. Press and hold key to switch output function. Long press key to switch range and press key to select a starting point.

You can press key to start output, and press again key to pause the output. Press to exit **automatic ramp/automatic step** menu.

7.6 Current Measurement/Loop Transmitter mA Measurement

Loop transmitter mA measurement provides 24V loop power, and also can measure the current value in the loop. In this mode (As Fig 7.4) , the circuit power has series resistor greater than 250Ω, which can be compatible with HART devices without using external resistor.

7.6.1 Range Switching

In the **current measuring/loop transmitter mA measurement** interface, long press key to switch current range. The **current**

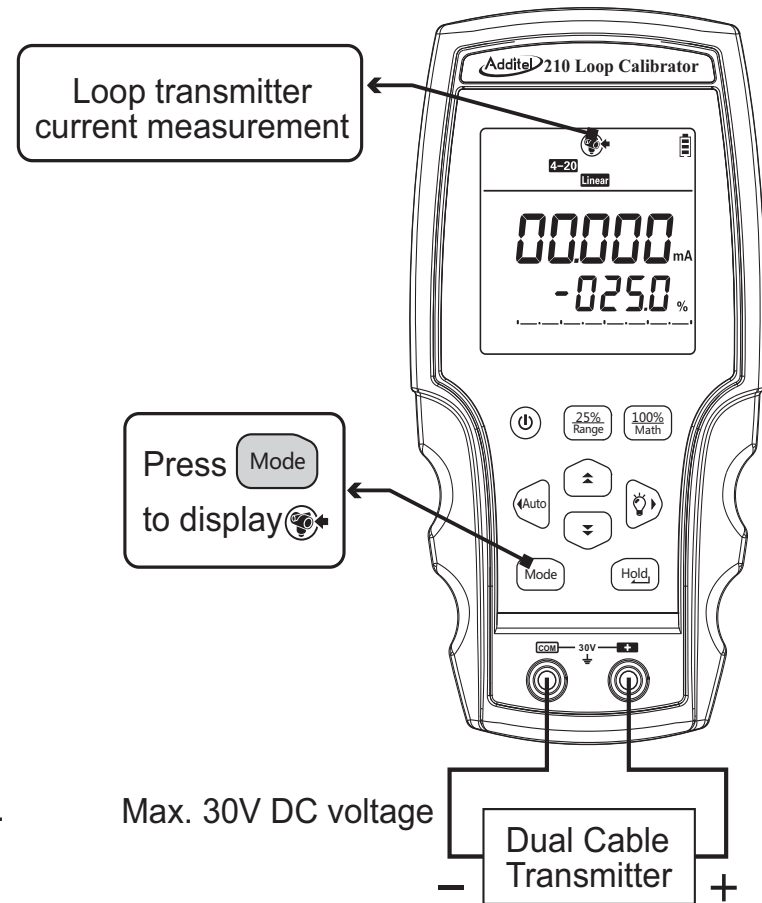





Fig 7.4 Loop Transmitter Current Measurement Configuration

measurement/loop transmitter mA measurement has three ranges:

- ■ ◆ 4 ~ 20mA (0% ~ 100%) [default]
- ■ ◆ 0 ~ 20mA (0% ~ 100%)
- ■ ◆ 0 ~ 24mA (0% ~ 100%)

7.6.2 Function Selection

In the **current measuring/loop transmitter mA measurement** interface, long press  key to switch the percentage calculation function. The **current measurement/Loop transmitter mA measurement** provides two calculation functions:

- ■ ◆ Linear, [default] 
- ■ ◆ Square 

8. Menu Operation

8.1 Menu Structure

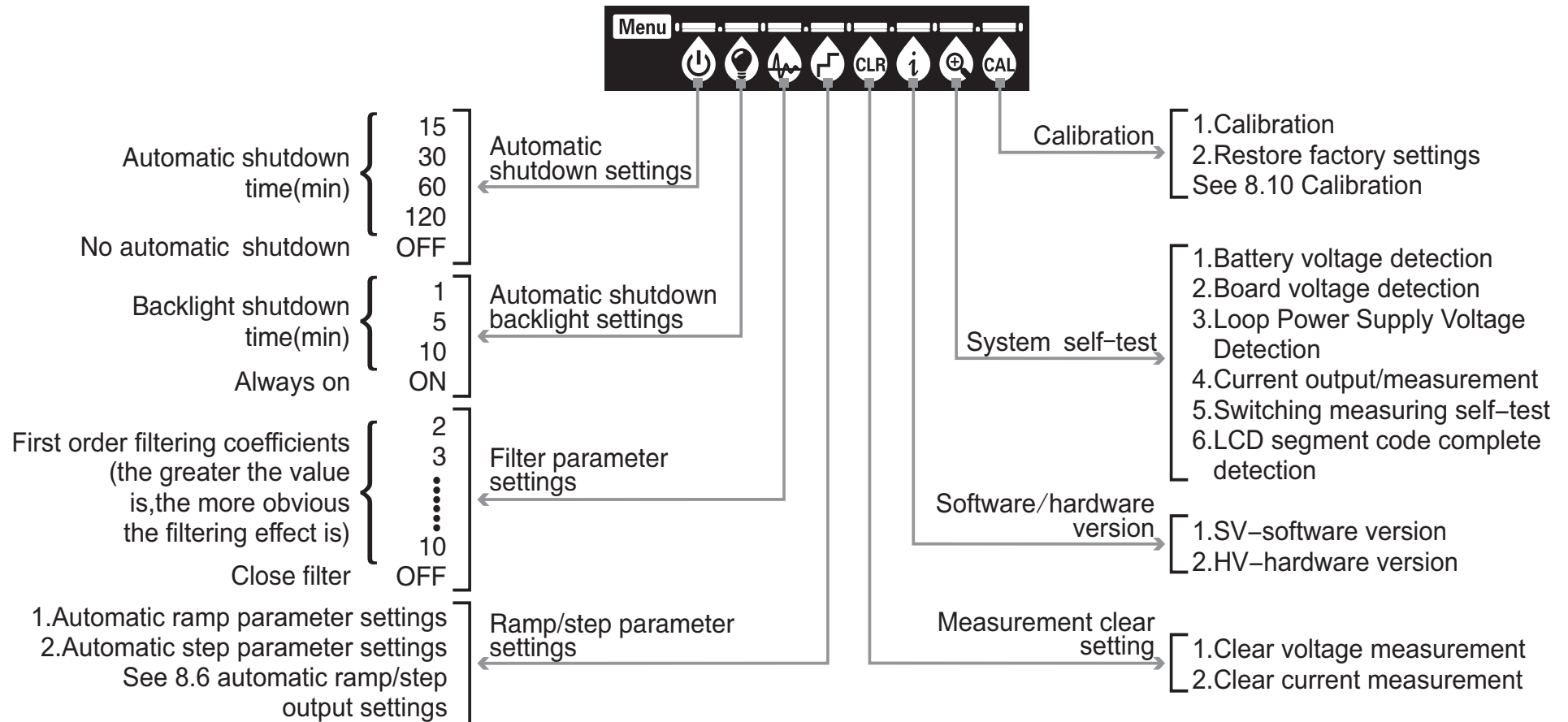

8.2 Menu Operation

8.2.1 Enter/Return to menu

In the measurement/output display interface, long press  key to enter the settings menu.



In any menu button, you can press  key to return to the previous short menu until you exit.

8.2.2 Switch Menu Items







In the menu interface, you can press  or  to toggle the items along the menu bar:





8.2.3 Modify Setting Menu Parameter

You can press  or  to switch the setup parameters of current menu.



8.2.3 Data Entry

- ■ ◆  Confirmation/ enter data
- ■ ◆  Cancel data input
- ■ ◆   Move the cursor left/right
- ■ ◆   Increase/decrease by 1

8.3 Auto Shutdown Setting



In the automatic  shutdown menu, press  or  to select auto shutdown time, 15/30/60/120 minutes are optional, or OFF (no auto shutdown).



8.4 Automatic Shutdown Backlight Setting

In the auto  shutdown backlight menu, you can press  key or  key to select the auto

backlight shutdown time, 1/5/10 minutes are optional, or ON (the backlight is always on).



8.5 Measurement Filter Parameter Setting

In the filter adjustment menu  if the measurement is voltage, current or loop transmitter current, the filter coefficients will be displayed directly. If there are other items, you can press  key to switch between measurement items.

Press  key or  key to select first order filtering coefficients, 2...10 are optional (the larger the value, the more obvious the filtering effect) or OFF (no filter).



8.6 Automatic Ramp/Step Output Setting

8.6.1 Ramp/Step switch







In the **automatic ramp/step setup** menu press  key or   key to switch between **automatic ramp output setting** and **automatic step output setting**.

8.6.2 Ramp Direction Setting

In the **automatic ramp/step setting** menu press  to set **automatic ramp/step direction**.



This icon  means the direction is 0%→100%→0% or 100% →0%→100%, and  means the 0%→100% or 100%→0%.

8.6.3 Ramp/Step Time Setting

In automatic ramp/step setting menu press  key to enter the time setting. Press   key to move the cursor and press   key to increase or decrease by 1 second. By pressing the  key again will confirm the entry or

press  key to cancel the entry.

8.7 Clear Menu Setting

In the clear setting menu , In the voltage measurement clear or current measurement clear menu, you can press  key to perform clear operation, the cleared measurement value will be observed in the main display interface.

8.8 Software/hardware Version



In the software/hardware version browse menu , main display area  indicates that the software version is 1-01, sub display area  indicates the hardware version is 1-01.

8.9 Self-test



8.9.1 Self-test Description



When performing self-test, you will need to short the electrical measuring port. Self Test menu item contains the following self-tests: supply voltage detection, system voltage detection, loop power/voltage measurement self-test, current output/current measurement self-test, switch measurement self-test, and LCD test.

8.9.2 Self-test Item Switch

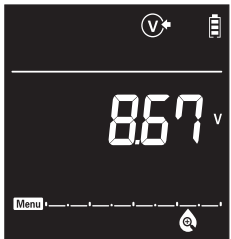
In the self-test menu , you can press  key to toggle self-test items (e.g. supply voltage detection, system voltage detection, etc.).

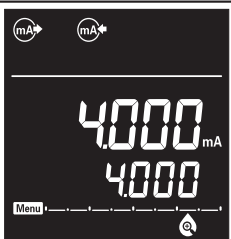
8.9.3 Self-test Item Description

| Test Item | Interface Schematic | Range | Notes |
|--|--|--|---|
| Supply voltage detection |  | Supply voltage: 6V ~ 10V | a.If the power is supplied only by the battery, the displayed voltage will be the battery voltage b.If you insert the power adapter, the displayed voltage will be the adapter voltage |
| System Power Detection |  | a.3.3V Voltage: 3.2V ~ 3.4V b.5V Voltage: 4.8V ~ 5.2V | — |
| Loop supply voltage /voltage measurement self-test |  | 22V~25V | If the range is exceeded additional troubleshooting or calibration may be required. |
| Current Output/Current Measurement Self test –4mA |  | 3.9mA~4.1mA | If the range is exceeded calibration is required. |

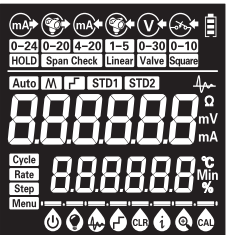
| | | | |
|---|--|---|--|
| <p>Current Output/Current Measurement Self test –20mA</p> |  | <p>19.9mA~20.1 mA</p> | <p>If the range is exceeded calibration is required.</p> |
| <p>Switch measurement self-test – OPEN</p> |  | <p>The main display area displays OPEN</p> | <p>—</p> |
| <p>Switch measurement self-test – CLOSE</p> |  | <p>The main display area displays CLOSE</p> | <p>—</p> |
| <p>LCD Detection</p> |  | <p>All pixels will illuminate</p> | <p>—</p> |

8.10 Calibration

We recommend your calibration standards to be at least four times more accurate than the ADT210.

8.10.1 Calibration Condition

Note: Ensure the following criteria are met during the calibration:



- ■ ◆ Ambient temperature $20^{\circ}\text{C} \pm 2^{\circ}\text{C}$; relative humidity **45%-75%**; atmospheric pressure **86kPa-106kPa**.
- ■ ◆ Allow at least a 15 min warmup time for the ADT210.

8.10.2 Calibration Item

ADT210 2-point calibration:

- ■ ◆ Voltage measurement: calibration points are 0 and 30V
- ■ ◆ Current measurement: calibration points are 4 and 20mA
- ■ ◆ Current output: calibration points are 4 and 20mA



8.10.3 Calibration Process



1) Select the  calibration menu, you can press  key, and enter the password “310” and press  key to confirm.

2) Press  key to toggle between **calibration items**(the first screen is default to **current output calibration item**).

3) Press  to browse the calibration data, and toggle between calibration points.



4) Press  to enter the calibration value.

- ■ ◆ **Current output calibration:** enter the value displayed by the current calibrator by pressing  key to confirm entry or pressing  key to cancel the entry.

- ■ ◆ **Current measurement/voltage measurement calibration:** When sourcing the standard value press the  key to confirm the entry or press  key to cancel the entry.
- 5) Press  to switch to the next calibration point, repeat step 4).

8.10.4 Restore Factory Calibration Data

Note: when restoring factory calibration data, all other settings parameters will be reset to factory settings.

Select the  calibration menu, you can press  to enter, and enter password “310”. Press  key to confirm, the system will reboot.

9 Specification

9.1 Main Specification

- ◆ Specifications are based on 1 year and an environmental temperature of 10°C to 30°C .
- ◆ Temperature coefficient: -10°C~10°C and 30°C~50°C: $\pm 0.005\%FS/^\circ C$

9.1.1 DC Voltage Measurement

- ◆ Range:0~30V
- ◆ Resolution:1mV
- ■ ◆ Input impedance:1M Ω
- ■ ◆ Accuracy:ADT209: $\pm(0.03\%RD + 2mV)$ ADT210: $\pm(0.01\%RD + 2mV)$

9.1.2 DC mA Measurement /Loop Transmitter Current Measurement

- ■ ◆ Range:0~24mA
- ■ ◆ Resolution: 1 μA

□ ■ ◆ Accuracy: ADT209: $\pm(0.03\%RD + 2\mu A)$ ADT210: $\pm(0.01\%RD + 2\mu A)$

□ ■ ◆ Loop transmitter current measurement: maximum load 700 Ω

9.1.3 Source/Sink DC Current Output

□ ■ ◆ Range: 0~24mA

□ ■ ◆ Resolution: 1 μA

□ ■ ◆ Accuracy: ADT209: $\pm(0.03\%RD + 2\mu A)$ ADT210: $\pm(0.01\%RD + 2\mu A)$

□ ■ ◆ Source mode: Maximum load 700 Ω /20mA

□ ■ ◆ Sink mode: External loop voltage nominal 24V, maximum 30V, minimum 12V

9.1.4 Mechanical /Live Switch Measurement

□ ■ ◆ Equipment:

* Input impedance: greater than 500M Ω

□ ■ ◆ Charged:

* Input impedance: greater than 500M Ω

* Trigger level: low <0.3V, high > 2V

9.2 General Specifications

□ ■ ◆ Pressure: Maximum voltage between any terminals and ground or between any two terminals: 30V

□ ■ ◆ Storage Temperature: -20 $^{\circ}C$ ~ 70 $^{\circ}C$

□ ■ ◆ Operating Temperature: -10 $^{\circ}C$ ~ 50 $^{\circ}C$

- ◆Relative Humidity:
 - * 95%/30°C
 - * 75%/40°C
 - * 45%/50°C
- ◆Operating altitude: Maximum 3000m
- ◆Vibration Shock:
 - * Random 2g, 5 to 500Hz
 - * 1m drop
- ◆Power Requirements: A 9V alkaline battery (ANSI/NEDA 1604A or IEC6LR61) or standard DC9V adapter
- ◆Battery Life:
 - * Output mode:18 hours(12mA /500Ω)
 - * Measurement mode:50 hours
- ◆Dimensions: 163mm(L) × 83mm(W) × 41mm(H) (with holster)
- ◆Weight: 350g (with holster)
- ◆Protection class: IP54
- ◆Certification: CE

10. Replace the battery

Warning:

- ◆ To avoid false readings, the battery should be replaced immediately when the display indicates that the battery is low or does not start properly
- ◆ Use a 9V alkaline battery (ANSI/NEDA 1604A or IEC6LR61)

Battery replacement:

- 1) Disconnect test lead from the input signal;
- 2) Long press  key to turn off the calibrator
- 3) Remove the protective cover;
- 4) Open the battery door behind the calibrator;
- 5) Remove the battery;
- 6) Insert the replacement battery to make sure the battery polarity is correct;
- 7) Replace the battery door and determine that the batteries are in place;
- 8) Place the calibrator into the leather.

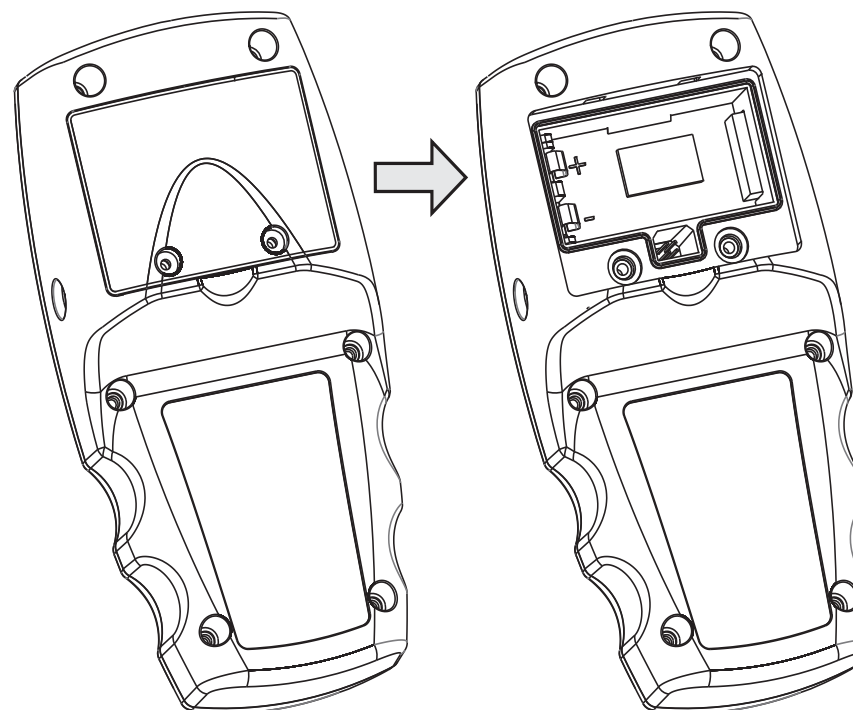

10.1 Replace the battery



11. Manufacturer Information

Additel Corporation

2900 Saturn St #B

Brea, CA 92821, USA

Phone: 714-998-6899

Email: service@additel.com

Website: www.additel.com

