

MX2500 Replacement Electrode (MX2500-ELECTRODE) Installation Instructions

IMPORTANT: The electrode is shipped with the junction and glass bulb in storage solution. *The junction and the glass bulb must be kept in storage solution when not being calibrated or deployed in water.*

IMPORTANT: This new pH electrode is uncalibrated. Once installed, it must be calibrated before configuring and deploying the logger.

1

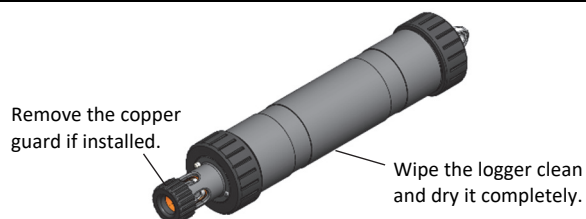

2



3

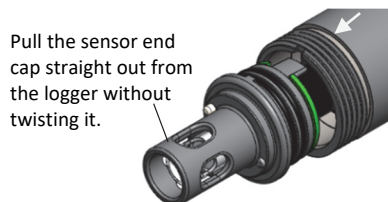

4

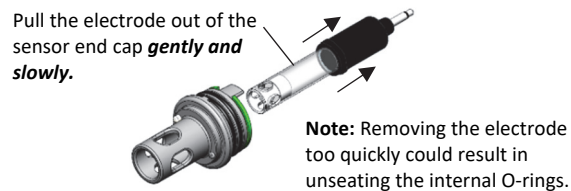

5

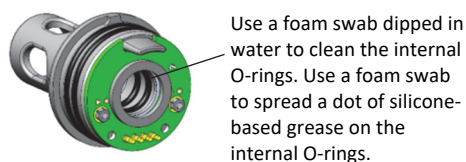

6



22671-C MAN-MX2500-ELECTRODE

7

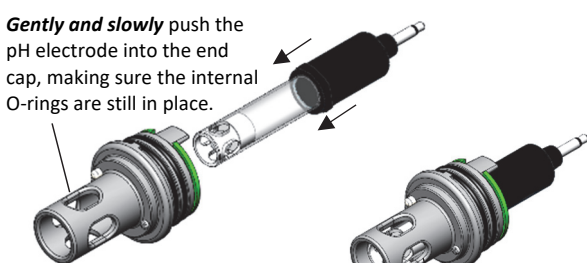

Note: If done too quickly, this process can unseat the internal O-rings.

Gently twist the electrode so the holes in the sensor align with the holes in the end cap

8

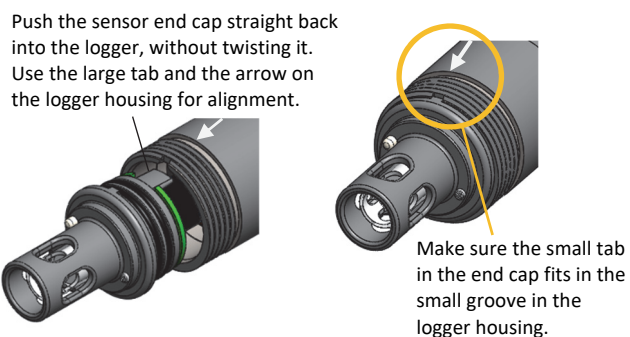

9

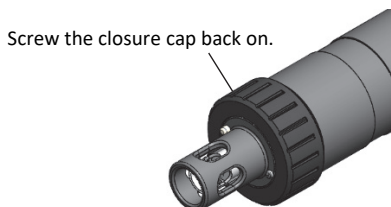

The logger manual is available at www.onsetcomp.com/support/manuals/22511-mx2501-manual.

IMPORTANT: Keep the electrode in storage solution until you are ready to calibrate and to deploy the logger.