



The M-RSA Solar Radiation Shield is recommended for temperature and RH measurement accuracy in locations exposed to direct or reflected solar radiation. It can be mounted on masts between 1 and 1-5/8 inches (25 and 41 mm) in diameter or flat vertical surfaces. The Solar Radiation Shield works with HOBO® Pendant® loggers (UA-00x-xx), the HOBO Water Temp Pro v2 (U22-001), the TidbiT v2 (UTBI-001), HOBO Prov2 Internal Temp/RH data logger (U23-00x), HOBO MX2200 and MX2300 series data loggers, and external temperature sensors for Onset data loggers.

## Tools and Materials Needed

You may need the following tools and materials depending on the logger you are using and how you will be mounting the Solar Radiation Shield. Read this manual before beginning the installation to be sure you have everything you need.

- Small Phillips-head screwdriver and medium slotted-head screwdriver
- Wrench or pliers
- Drill with 3/16 in. drill bit (4.7 mm) to drill pilot holes if attaching solar radiation shield to the top of a post
- Adjustable wrench or 11/32 in. wrench and 7/16 in. wrench to tighten hex nuts (11/32 in. wrench) or to drive lag screws into wall or post (7/16 in. wrench)
- Four 3/4 in. x 1-1/2 in. lag screws (38 mm long) to attach Solar Radiation Shield to a post or wall
- Three #8 x 1 in. screws (25 mm long) to attach Solar Radiation Shield on the top of a post (if #8 x 2-3/4 in. pan head screws provided create clearance problems)
- Hose clamp for mounting to mast greater than 1-5/8"

**Note:** The mounting bracket may contain more holes than depicted in the illustrations.

## Location Recommendations

Use the following guidelines to determine the best location for mounting the Solar Radiation Shield.

- The Solar Radiation Shield works best when in a location with a steady breeze. Mount away from fences, buildings, trees, or other obstructions.
- Install over plants or soil if possible.
- Do not install over or near sprinklers. The Solar Radiation Shield is not designed to protect the sensor from water sprayed upwards.
- If attaching to a building, the preferred location is the north side in the northern hemisphere and the south side in the southern hemisphere.

## Attaching HOBO Loggers or Sensors

1. Remove the mounting bracket from the top plate by unscrewing the hex nuts and removing the washers and spacers from each of the screw ends.
2. Slide the top two plates off the stack.
3. Attach the logger to the underside of the closed plate second from the top. If you will be attaching an external sensor, skip to the next step.

To attach a HOBO Pendant logger (UA-00x-xx) or a TidbiT v2 (UTBI-001) to the Solar Radiation Shield, install the 1/2 in. screw eye into the standoff of the closed plate as shown. Attach the logger with a cable tie.

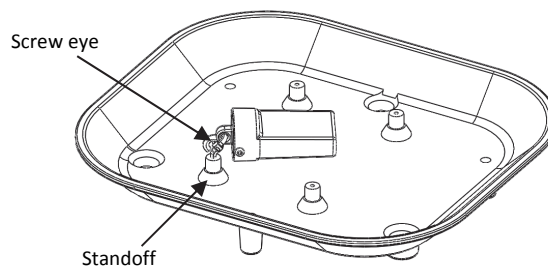

To attach a HOBO Water Temp Pro v2 (U22-001) or a HOBO Pro v2 Internal Temp/RH logger (U23-00x) to the Solar Radiation Shield, place the logger in the clamp provided in the U23 Clamp Kit. Secure the clamp into the standoff on the closed plate as shown with the screw and washer provided in the kit. **Note:** The HOBO Water Temp Pro v2 can be mounted into the shield using the U23 Clamp Kit, but the clamp fit will not be as snug as it is for the HOBO Pro v2 Internal Temp/RH logger.

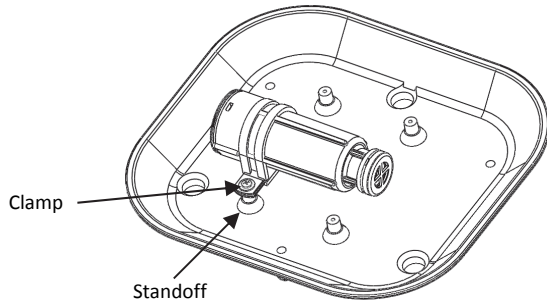

To attach a HOBO MX2200 or MX2300 series logger, use the solar radiation shield bracket (MX2200-RS-BRACKET or MX2300-RS-BRACKET). Attach the logger and bracket to the underside of the closed plate with the screws included as shown below. **Note for MX2202 loggers:** To log both temperature and sunlight, you will need two MX2202 loggers. Place one logger in a solar radiation shield to log temperature and the other mounted flat on top of the solar radiation shield to record sunlight.

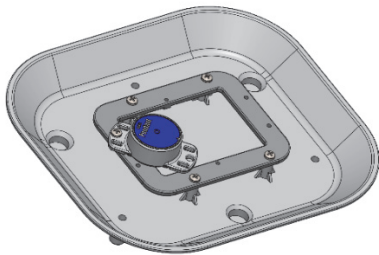

MX2201 Logger

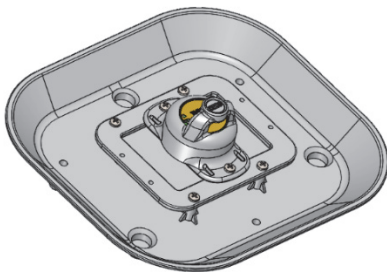

MX2203 Logger

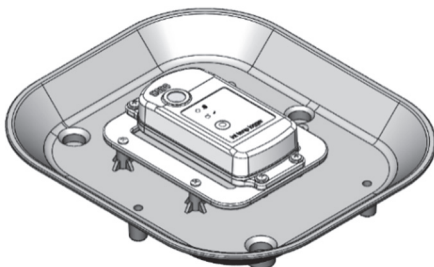

MX2301/MX2305 Logger

4. If attaching an external temperature sensor from a HOBO logger, follow these steps.
  - a. Place the sensor cable into the notch on one of the clip mounts and hold it in place. Hold the clip mount so the raised semi-circle at the top of the notch will face up.
  - b. Position the second clip mount over the first, with the notch facing in the opposite direction, securing the sensor cable between the two notches. When positioning the second clip mount, make sure the raised semi-circle will face down.
  - c. Position the clip mounts over two of the mounting posts on the closed plate. Make sure you orient the clip mounts as shown at right.
  - d. Attach the clip mounts to the mounting posts using two #4 x 1/2 in. pan head self-threading screws and two #4 flat washers.

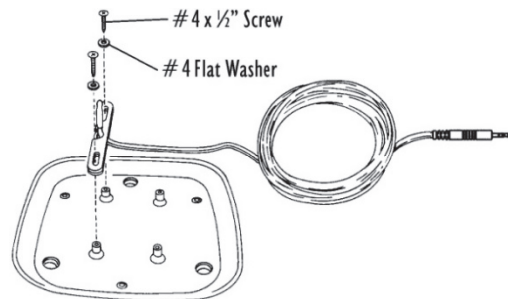

- e. Once secured, adjust the sensor so it and approximately 1/4 in. (6 mm) of cable protrude from the clip mounts.
- f. Place the cable clamp around the sensor cable approximately 8 in. (20 cm) from the sensor.

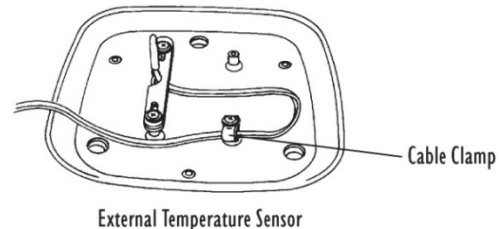

- g. Secure the cable clamp to one of the remaining mounting posts (using a #4 x 1/2 in. pan head self-threading screw and a #4 flat washer) so that a loop of cable is formed. Make sure to mount the clamp so that the flat side will be up and the bulge side down. Tighten the screw completely so that the cable cannot move within the cable clamp.
  - h. Feed the remaining length of cable attached to the closed plate through the open centers of the plates below it.
5. Slide the closed plate over the threaded rod ends protruding from the top of the open plates so that the logger or sensor end is enclosed within the center of the open plates.
  6. Slide the top plate over the threaded rod ends protruding from the closed plate with the logger.
  7. Continue to the applicable mounting instructions for your logger deployment.

## Mounting on the Side of Post/Wall or a Pipe

1. Place the spacers over the protruding rod ends on the top plate of the shield.
2. Orient the bracket in relation to the shield as shown in these examples depending on how you will be mounting the shield.

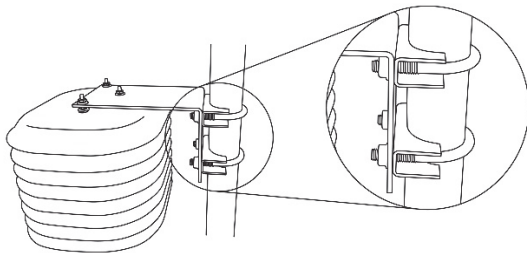
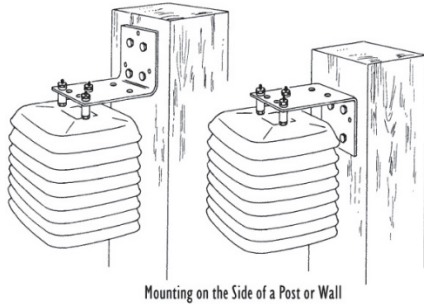

3. If mounting to a post or wall:
  - a. Attach the mounting bracket to the mounting surface in the desired location using four 1/4 in. x 1-1/2 in. lag screws.

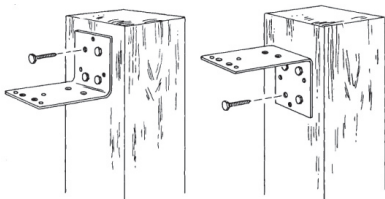

- b. Secure the mounting bracket to the Solar Radiation Shield using the #8 flat washer, #8 split lock washer, and #8 hex nut on each of the screw ends. Tighten until the mounting bracket is firmly attached to the Solar Radiation Shield.

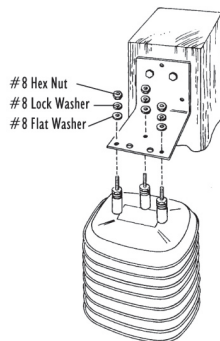

4. If mounting to a pipe or mast with an outside diameter between 1 and 1-5/8 inches (25 and 41 mm):

- a. Secure the mounting bracket to the Solar Radiation Shield using the #8 flat washer, #8 split lock washer, and #8 hex nut on each of the screw ends. Tighten until the mounting bracket is firmly attached to the Solar Radiation Shield.

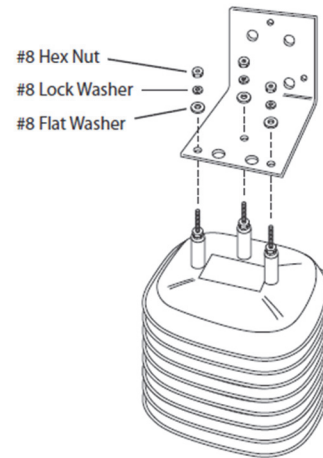

- b. Use the holes and 1-5/8 inch saddle-clamp U-bolts to attach the bracket to a tripod or mast.
- c. If you want to mount on a larger post or mast, there are slots in the bracket for mounting with a hose clamp (user supplied.)

## Mounting on the Top of a Post

Mounting the shield to the top of a post requires that the bracket be attached to the bottom plate of the shield instead of the top as shipped.

### Attaching Mounting Bracket

1. Place the spacers, hex nuts, lock washers, and flat washers on the ends of the threads protruding from the top plate.
2. Turn over the shield and unscrew the wing nuts on the bottom to remove the bottom plate from the stack.
3. Using a drill with a 3/16 in. (4.7 mm) drill bit, drill three holes through the bottom plate in the locations marked by the small dimples on the bottom of the plate.

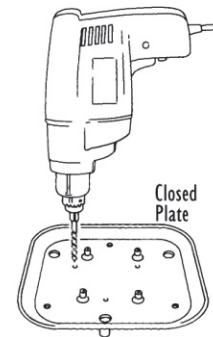

4. Place a #8 flat washer over the end of each of the #8 x 2-3/4 in. pan head screws. If the extra length of the screw end protruding from the bottom of the Solar Radiation Shield creates a clearance problem, you will need to use #8 x 1 in. screws.

5. Slide three #8 x 2-3/4 in. pan head screws (with washers) up through the holes you just drilled.

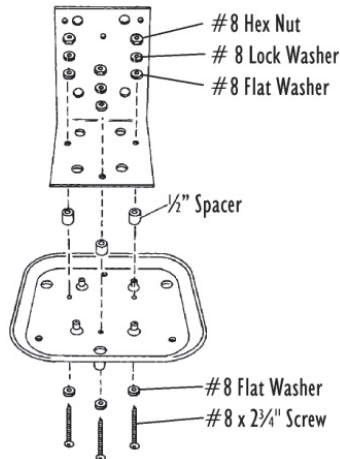

6. Place a 1/2 in. spacer over each of the screw ends protruding from the closed plate.
7. Slide the mounting bracket over the screw ends protruding from the closed plate.
8. Secure the mounting bracket to the closed plate using a #8 flat washer, a #8 split lock washer, and a #8 hex nut on each of the screw ends. Tighten until the mounting bracket is firmly attached to the closed plate.
9. Slide the plate with the mounting bracket back onto the stack.
10. Screw the #8 wing nuts onto the exposed ends of the #8 x 5 in. threaded rods and tighten until snug.
11. Use four 1/4 x 1-1/2 in. lag screws to attach the mounting bracket to the mounting surface in the desired location.

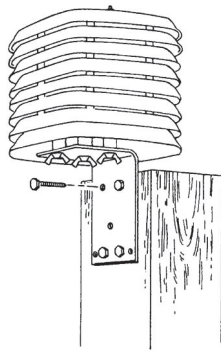

## Reading Out the Logger

To read out HOBO MX series loggers that have been configured with Bluetooth Always Off disabled, stand within communication range of the shield and logger with a mobile device and use HOBOMobile® to connect to the logger and read it out.

For all other loggers and for HOBO MX series loggers that have been configured with Bluetooth Always Off enabled, follow these steps to read out the data from the logger:

1. Remove the bottom plates for a top-mounted shield, or remove the top plates for a bottom-mounted shield.
2. If you are reading out a HOBO Pendant logger (UA-00x-xx) or a TidbiT v2 (UTBI-001), you can keep the logger attached to the shield while offloading data.

If you are reading out a HOBO MX series logger with Bluetooth Always Off enabled, keep the logger attached to the shield. Press the button on the logger to wake up communications. Use HOBOMobile to connect to the logger and read it out.

If you are reading out a HOBO Water Temp Pro v2 (U22-001) or a HOBO Pro v2 Internal Temp/RH logger (U23-00x), unscrew the clamp that secures the logger to the shield and remove the logger. After reading out the logger, place it back in the clamp and screw it back in.

3. Reattach the bottom or top plates as applicable.

## Maintenance Instructions

- The effectiveness of the Solar Radiation Shield will be reduced if the surfaces of the shield become dirty. Wipe the surfaces of the shield using a damp cloth to remove dirt, debris, etc.
- Keep areas between Solar Radiation Shield plates free of debris that may obstruct air flow e.g., leaves, twigs, webs, nests. DO NOT remove nesting insects or animals by spraying insect killer of any kind into the Solar Radiation Shield because this may damage the sensors and the Solar Radiation Shield.