

Important: If you have not already registered the RX3000 station with HOBOLink® and set up the station communications, follow the instructions in the *HOBO RX3000 Remote Monitoring Station Quick Start* before continuing (go to www.onsetcomp.com/resources/documentation/18254-man-qsg-rx3000).

1 Stop the RX3000 station and connect to HOBOLink.

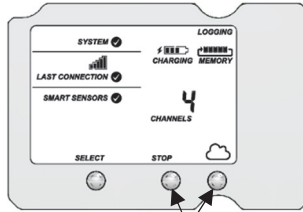

Press the Stop button if the station is currently logging and then press the Connect button to upload the latest data to HOBOLink.

5 Power up the RX3000 station.

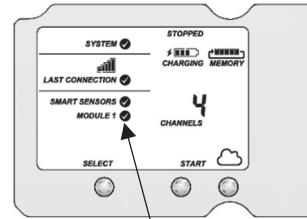

Plug in the battery and then the charging device, and wait for the station to power up. Verify that the new module is listed on the LCD screen with a checkmark. The station should automatically connect to HOBOLink (press the Connect button on the station if it does not).

2 Power down the RX3000 station.

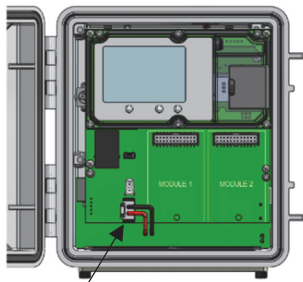

Disconnect the battery and unplug any charging device.

3 Install the RXW Manager module.

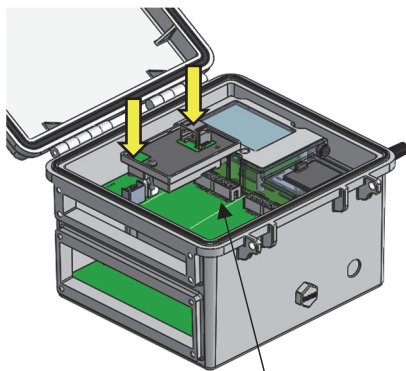

Insert the connector on the back of the module into the receptacle in the left or right module slot. Use a Phillips-head screwdriver to tighten the screw at the bottom of the module.

4 Connect the RXW Manager to the module .

Plug the cable from the RXW Manager into the jack on the module, making sure the cable is inserted through the bottom of the station case. Do not reconnect the power on the station until the RXW Manager is plugged in as shown.

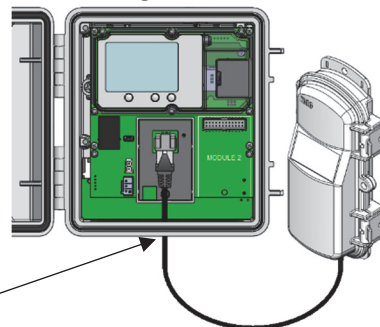

6 Update the RX3000 station firmware.

If you added the module to an RX3000 station that was previously in use, you will need to update the station firmware. If you have a new station, go to step 7.

- a. In HOBOLink, go to Devices, then RX Devices, and click the station name.
- b. On the station page, click Overview and scroll down to Device Information.
- c. On the General tab under the Firmware Version, click the firmware upgrade link.
- d. Select Upgrade on Next Connection and click Save.
- e. Press the Connect button on the station to connect to HOBOLink and start the firmware upgrade.
- f. Wait for the firmware upgrade to complete. The upgrade icon should be gone in HOBOLink once the upgrade is successful. If the station firmware is not successfully installed, it could be because there is an interruption in cellular service or poor signal strength. Contact Onset Technical Support for help.

7 Configure the module in HOBOLink.

Set the logging interval for the module in HOBOLink. Go to Devices, then RX Devices. Select the icon next to your station and select Module/Sensor Configuration. Select Module <1 or 2>: Wireless Sensors Logging, enter a logging interval, and click Save.

Press the Start button on the RX3000 station to begin logging. See the HOBOLink Help for details on how to change connection intervals, view data, check sensor node status, and more.

Installing the Bracket and Sensor Node

1

Orient the bracket so the text TOP is facing upwards.

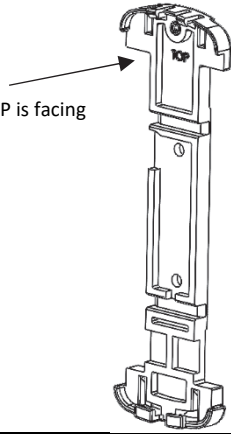

2

To install the bracket onto a wall, use the two long screws included in the package. Screw the bracket to a wall using the two holes on the mid-section of the bracket.

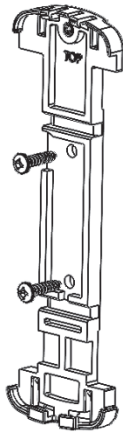

3

To install the bracket onto a pole, slip a cable tie through each of the channels on the bracket and fasten the tie around the pole.

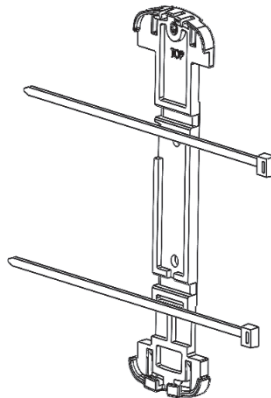

4

Insert the bottom of the sensor node into the retaining clips on the bottom of the bracket then press the top of the sensor node into the clips at the top of the bracket.

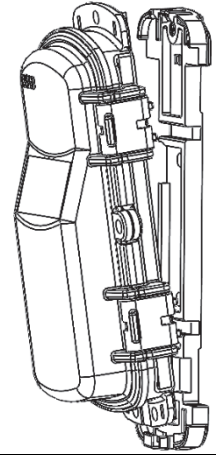

5

Use the short screw included in the package to fasten the sensor node to the bracket.

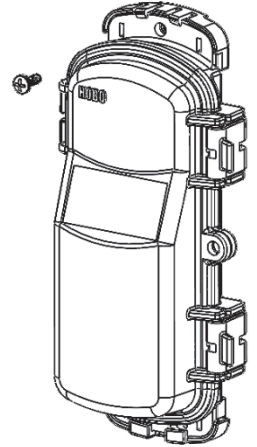

6

Close the sensor node and use a padlock to keep it secure. **Note:** Ensure that the node seal is clean from foreign debris.

Mount the Manager and add Sensor Nodes and repeaters to the network.

- Mount the manager as high as possible above the RX3000 station to increase the radio signal and line of sight.
- Make sure the RXW Manager cable is hanging straight down and not pulled tightly to the side to connect to the station.
- Add sensor nodes and any repeaters to the wireless network and then deploy them.

Follow the tips on the reverse side for setting up the network.

Note: Make sure that the RXW Manager cable and all other cables and wires are routed through weatherproof cable channels. Refer to the RX3000 manual at www.onsetcomp.com/resources/documentation/22248-rxmod-rxw-manual for details.

Tips for Setting up the HOBOnet Wireless Sensor Network

- Stay close to the RX3000 station when adding sensor nodes to the wireless network because you will need to access both the station and the sensor node at the same time. After the sensor node has successfully joined the wireless network, you can then move it to its deployment location.
- Check the signal strength on the sensor node LCD on the location where you want to place the sensor node. If there is only one or two bars on the signal strength indicator, consider moving the sensor node to a location where the signal strength is stronger.
- Make sure sensor nodes are mounted a minimum of 1.8 m (6 feet) above the ground or vegetation to help maximize distance and signal strength as shown at right.
- Consider using plastic poles such as PVC to mount the sensor nodes.
- Make sure each sensor node and repeater is positioned so that the built-in solar panel receives optimal sunlight throughout each season as shown at right. It may be necessary to periodically adjust the sensor node position as the path of the sunlight changes throughout the year or if tree and leaf growth alters the amount of sunlight reaching the solar panel.
- There should not be more than five sensor nodes in any direction at their maximum transmission range from the RXW Manager. Data logged by a wireless sensor must travel or “hop” across the wireless network from one sensor node to the next until it ultimately reaches the RXW Manager at the RX3000 station. To make sure the data can successfully travel across the network, the sensor node should not be more than five hops away from the manager.
- Obstructions between sensor nodes can prevent reliable network communication. If the sensor node is blocked by a small obstruction (e.g. a pole, the RX3000 station, shrubbery), then move the sensor node to a location where the obstruction is not blocking the path to the nearest sensor node. If there is a change in elevation between sensor nodes or a large obstruction is in the way (e.g. a building as shown in the example below or tree), then either reposition the sensor node until there is full line of sight to the next sensor node or add a repeater between them.
- Use the Map feature in HOBOLink for a bird’s eye view of the network and wireless paths. See the HOBOLink Help for details on this and other ways to monitor the status of your network and sensor data.

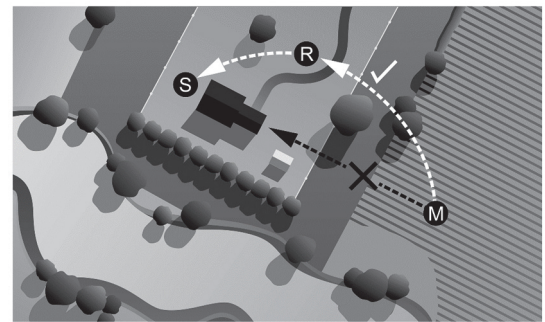
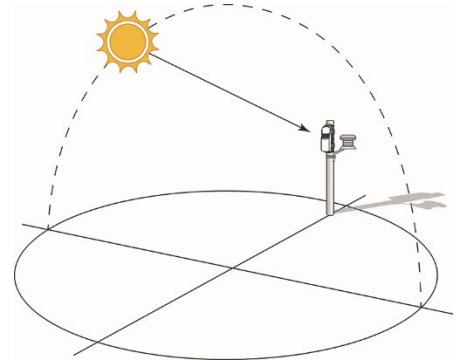
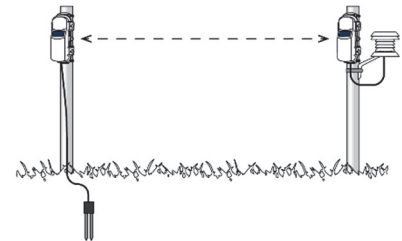

S Station R Repeater M Mote



For instructions on adding a sensor node to the network and complete details on the RX3000 station, scan the code at left or go to www.onsetcomp.com/resources/documentation/18255-rx3000-manual.



For specifications and other details about the RXW Manager, refer to the full product manual. Scan the code at left or go to www.onsetcomp.com/resources/documentation/22248-rxmod-rxw-manual.

For all HOBOnet Wireless Sensor Network product manuals including specific sensor nodes, go to www.onsetcomp.com/resources.