

JUMO miroTRON

Electronic thermostat with PID two-state controller function



Operating Manual



70109000T90Z001K000

V1.00/EN/00771097/2022-12-01

Further information and downloads



qr-701090-en.jumo.info

1	Safety	7
1.1	Symbols and signal words	7
1.2	Intended use	7
1.3	Safety information	8
1.4	Qualification of personnel	8
2	Description	9
2.1	General overview	9
2.2	Brief description	9
2.3	Identifying the device version	10
2.3.1	Nameplate	10
2.3.2	Order details	11
2.3.3	Scope of delivery	11
2.3.4	Accessories	11
2.4	Block diagram	12
2.5	Thermostat and controller function	12
2.5.1	Thermostat	12
2.5.2	PID two-state controller	12
2.5.3	Autotuning	12
2.6	Inputs and outputs	13
2.6.1	Analog and digital input	13
2.6.2	Digital output	13
2.6.3	Micro USB connection	14
2.7	Timer	14
2.8	Temperature display	14
2.9	Limit value monitoring	15
3	Acceptance of goods, storage, and transport	17
3.1	Checking the delivery	17
3.2	Important information about storage and transport	17
3.3	Returning goods	17
3.4	Disposal	18
4	Mounting	19
4.1	Installation instructions	19
4.2	Dimensions	20
4.2.1	Type 701090	20
4.2.2	Type 701091	21
4.2.3	Installation dimensions	21
4.3	Panel mounting	22

Contents

5	Electrical connection	23
5.1	Installation notes	23
5.2	Connection elements and connectors	24
5.3	Connection diagram	25
5.3.1	Type 701090 (Ø 60) and Type 701091 (Ø 80)	25
5.4	Galvanic isolation	26
6	Operation	27
6.1	Display and control elements	27
6.1.1	Operating overview	28
6.1.2	The level concept	30
6.2	Device response when switching on	30
6.3	Handling input errors	31
6.4	Language selection	31
6.5	Basic status	32
6.6	User level	32
6.7	Level inhibit	33
6.8	Autotuning – only with controller function	33
6.9	Manual mode – only for controller function	34
6.10	Standby mode	34
6.11	Time formats	34
7	Configuration	35
7.1	Selectors	35
7.1.1	Digital selector	35
7.1.2	Analog selector	36
7.2	Setup program	36
7.2.1	Online parameters	37
7.2.2	Start-up parameters	38
7.2.3	Customized linearization	38
7.3	Configuration – Menu	40
7.3.1	System data	40
7.3.2	Display and operation	41
7.3.3	Analog input	44
7.3.4	Digital input	45
7.3.5	Thermostat	45
7.3.6	Controller	46
7.3.7	Controller parameters	47
7.3.8	Limit value monitoring	49

7.3.9	Service53
7.3.10	Digital control signals53
7.3.11	Timer55
7.3.12	Digital output57
7.4	Device info – Menu57
8	Maintenance, cleaning, troubleshooting.	59
8.1	Service59
8.2	Maintenance59
8.3	Cleaning59
8.4	Troubleshooting60
8.4.1	Types of errors60
8.4.2	Error messages60
9	Technical data	61
9.1	Analog input61
9.2	Digital input61
9.3	Digital output61
9.4	Display62
9.5	Electrical data62
9.6	Environmental influences63
9.7	Housing63
9.8	Approvals and approval marks63

Contents

1.1 Symbols and signal words

General

This manual contains information that must be observed in the interest of your own safety and to avoid material damage. This information is supported by symbols which are used in this manual as indicated.

Please read this manual before starting up the device. Store this manual in a place that is accessible to all users at all times.

If difficulties occur during startup, please do not intervene in any way that could jeopardize your warranty rights!

Warning symbols



DANGER!

This symbol indicates that **personal injury from electrocution** may occur if the appropriate precautionary measures are not taken.



WARNING!

This symbol in connection with the signal word indicates that **personal injury** may occur if the respective precautionary measures are not carried out.



CAUTION!

This symbol in connection with the signal word indicates that **material damage or data loss** will occur if the respective precautionary measures are not taken.



CAUTION!

This symbol indicates that **components could be destroyed** by electrostatic discharge (ESD = Electro Static Discharge) if the respective cautionary measures are not taken.

Only use the ESD packages intended for this purpose to return device inserts, assembly groups, or assembly components.

Note symbols



NOTE!

This symbol refers to **important information** about the product, its handling, or additional benefits.



FURTHER INFORMATION!

This symbol is used in tables and indicates that **further information** is provided after the table.



DISPOSAL!

At the end of its service life, the device and any batteries present do not belong in the trash! Please ensure that they are **disposed of** properly and in an **environmentally friendly** manner.

1.2 Intended use

The device is designed for use in an industrial environment as specified in the technical data. Other uses beyond those defined are not viewed as intended uses.

1 Safety

The device has been manufactured in compliance with applicable standards and directives as well as the applicable safety regulations. Nevertheless, improper use may lead to personal injury or material damage.

To avoid danger, only use the device:

- For the intended use
- When in good order and condition
- When taking the technical documentation provided into account

Risks resulting from the application may arise, e.g. as the result of missing safety provisions or wrong settings, even when the device is used properly and as intended.

1.3 Safety information



DANGER!

Risk to life due to electric shock

Risk of injury when touching live parts!

- ▶ Only qualified electricians are allowed to connect and install an electrical device that is not already ready to use.
 - ▶ Before working on the system or device, switch off the voltage and secure it so that it cannot switch on again.
 - ▶ Do not touch electronic components when they are live.
 - ▶ Always observe the relevant accident prevention regulations and safety requirements for electrical devices.
-



CAUTION!

Risk of device damage

If the device is not supplied with the voltage specified on the nameplate, this could cause damage to the device.

- ▶ Only supply voltage from a voltage source that matches the specifications on the nameplate.
-



CAUTION!

The front of the device and housing have different protection types!

The protection type IP65 (front-side) is only guaranteed if the seal is flush and even.

- ▶ Use the mounting frame or both mounting elements as shown in the figure and ensure an even attachment!
-

1.4 Qualification of personnel

This document contains the necessary information for the intended use of the device to which it relates.

It is intended for staff with technical qualifications who have been specially trained and have the appropriate knowledge in the field of automation technology.

The appropriate level of knowledge and the technically fault-free implementation of the safety information and warnings contained in the technical documentation provided are prerequisites for risk-free mounting, installation, and startup as well as for ensuring safety when operating the described modules. Only qualified personnel have the required specialist knowledge to correctly interpret and implement the safety information and warnings contained in this document in specific situations.

2.1 General overview

The device is available in the following versions:

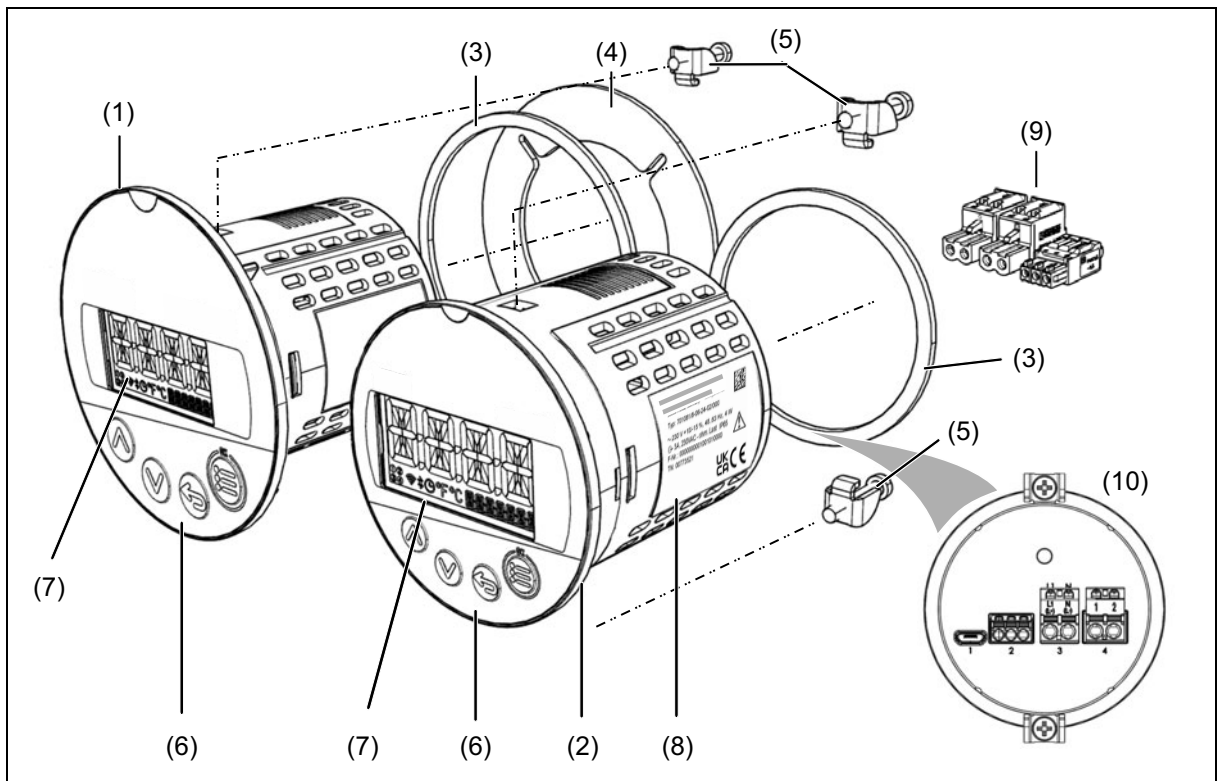

1	Type 701091, front panel 88 mm	2	Type 701090, front panel 68 mm
3	Seal	4	Adapter plate
5	Panel fasteners	6	Front panel with membrane keyboard, chapter 6.1 "Display and control elements", Page 27
7	Display	8	Nameplate, chapter 2.3.1 "Nameplate", Page 10
9	Pluggable terminal strips	10	Rear view with pluggable terminal strips chapter 5.2 "Connection elements and connectors", Page 24

2.2 Brief description

The electronic thermostat can be used as a heating or cooling thermostat or optionally as a PID two-state controller. It acquires the process variables via an RTD temperature probe. When used as a PID two-state controller, the controller structures P, I, PD, PI, and PID are possible. The device is equipped with a relay output (16 A).

The difference between the two types of devices is the diameter of the front panel: Type 701090 Ø 60.5 mm, Type 701091 Ø 80.5 mm. The round housing design allows the device to be used wherever round dial instruments were previously in use.

The device is characterized by simple, clearly structured operation supported by texts in English, German, French, and Spanish. Process values, texts, and parameters are shown in two 18-segment LCD displays. Additional display elements inform about the switch position of the output, the timer status, and temperature unit.

Pluggable terminal strips with PUSH IN technology enable fast electrical installation.

2 Description



Operation, parameterization, and configuration are carried out via a membrane keyboard with four keys. The setup program on a PC allows the device to be configured without any problems. No separate voltage supply is required when configuring via the USB interface (USB-powered).

2.3 Identifying the device version

2.3.1 Nameplate

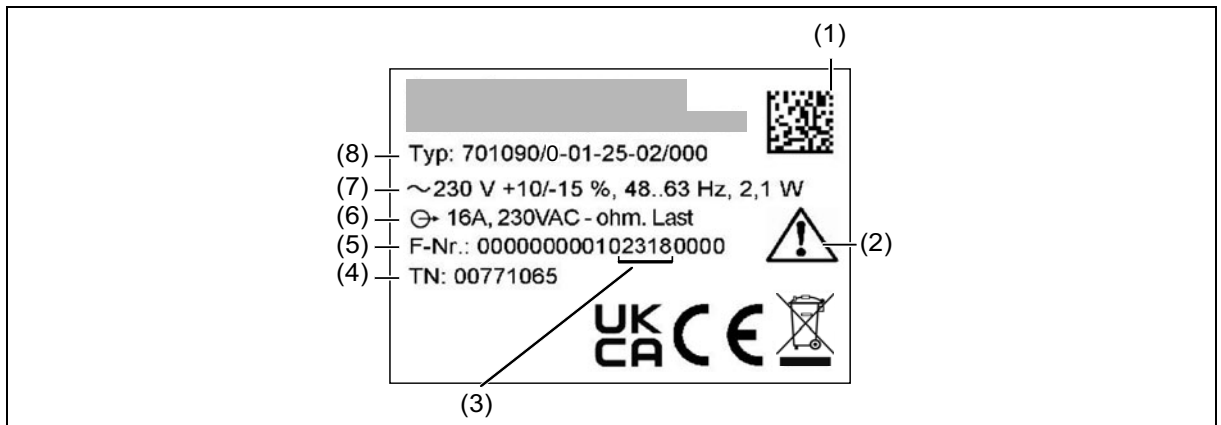
The specifications on the nameplate are for device identification purposes. It is stuck on the side of the device and contains the following information:



1	Data matrix code (for manufacturing purposes only)	2	Note "Read the operating manual"
3	Production date, Pos. 12-15 of F no.: Year number, calendar week	4	Part no.
5	Fabrication number (F no.)	6	Switching capacity (relay output)
7	Voltage supply - Direct voltage  - Alternating voltage 	8	Type, corresponds to the order details

2.3.2 Order details

(1) Basic type	
701090	Type 701090 with 1 relay, format (Ø 60 x 80) mm
701091	Type 701091 with 1 relay, format (Ø 80 x 80) mm
(2) Version	
0	Standard version
1	Customized hardware
2	Customized software
3	Customized hardware and software
(3) Input (measurement input group)	
01	1 RTD temperature probe Pt100, Pt1000 in two-wire circuit, 1 digital input
(4) Output	
25	1 relay (normally open contact AC 250 V, 16 A) resistive load
(5) Voltage supply	
02	AC 230 V, +10/-15 %, 48 to 63 Hz
05	AC 115 V, +10/-15 %, 48 to 63 Hz ^a
30	DC 12 to 24 V +15/-15 %
(6) Extra codes	
000	None
033	PID two-state controller

^a Minimum order quantity 50 pieces

	(1)	(2)	(3)	(4)	(5)	(6)					
Order code	<input type="text"/>	/	<input type="text"/>	-	<input type="text"/>	-	<input type="text"/>	-	<input type="text"/>	/	<input type="text"/>
Order example	701090	/	0	-	01	-	25	-	02	/	033

2.3.3 Scope of delivery

1 device in the ordered version
1 quick start guide
2 panel fasteners
Pluggable terminal strips

2.3.4 Accessories

Description	Part no.
Setup program	00777355
USB cable, A connector to Micro-B connector, length 3 m	00616250
Activation for PID two-state controller (setup program required)	00777354

2 Description

2.4 Block diagram

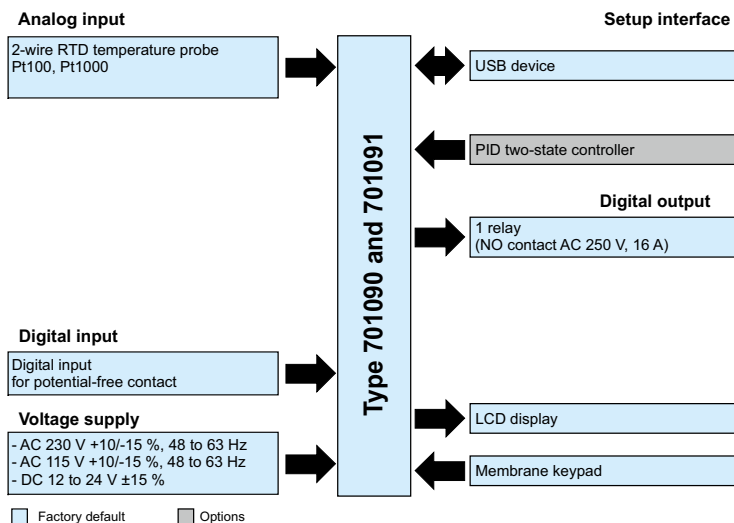

2.5 Thermostat and controller function

In addition to the standard thermostat function, the devices can also be used as PID two-state controllers, including autotuning according to the oscillation method.

The PID two-state controller can be ordered as an extra code or can be activated retrospectively via the setup program.

2.5.1 Thermostat

The thermostat function monitors the analog input to check it keeps to the configured thermostat setpoint value and, at the thermostat output, based on the function for heating or cooling, gives the signal for switching off or on, e.g. for a device downstream of the digital output (e.g. heating or cooling unit).



NOTE!

In order not to overload downstream units, both the minimum switch-on period and the minimum switch-off period can be configured. See "Thermostat", Page 45

2.5.2 PID two-state controller

The PID two-state controller implemented in the device has a switching output and can be parametrized with

P, I, PD, PI, or PID transmission behavior. In order for the controller structure to take effect, the proportional band must be $X_p > 0$.

2.5.3 Autotuning

For the purpose of using the device as a two-state controller, an autotuning function has been integrated into the device software. The autotuning function works according to the oscillation method. With this method, the device sets the output level alternately to 100 % and 0 %, which produces oscillation of the control variable.

In the case of a large control deviation between the setpoint value and actual value (for example, in the startup phase), the controller determines a switching line around which the control variable performs a forced oscillation during autotuning. The switching line is determined so that the actual value does not exceed the setpoint value if possible.

In the case of minor control deviation (e.g. if the control loop is in a steady state during operation), oscillation is forced around the setpoint value. In this respect, the setpoint value is definitely exceeded. The controller automatically chooses between the two procedures depending on the extent of the control deviation:

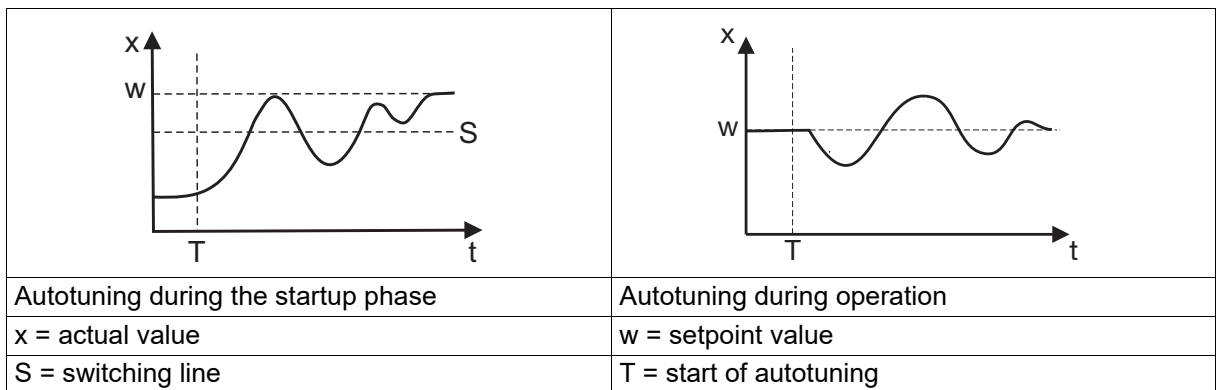

NOTE!

The autotuning function is started and stopped using the keypad or by a digital signal. It is not possible to start the autotuning function from manual mode.

Autotuning can be carried out as often as desired.

In the oscillation method, the output value limits Y1, Y2 are not active during the optimization for switched outputs and solid state outputs. However, these are taken into account when determining the parameters.

2.6 Inputs and outputs

2.6.1 Analog and digital input

The device is equipped with an analog input and a digital input.

Analog input

The analog input provides the actual value for the thermostat or controller function.



NOTE!

A customer-specific linearization of the analog input can be configured in the setup program with a formula or a table with max. 40 value pairs.

Digital input

The digital input is for the purpose of activating various different functions, such as setpoint changeover. The digital input can be operated through closing and opening an external potential-free contact.

2.6.2 Digital output

The device can switch actuators, such as power contactors, via the output. The device has the following output configuration:

Order code	Description
25	1 x normally open contact relay AC 250 V, 16 A, resistive load

2 Description

2.6.3 Micro USB connection

The device has a type B micro USB socket, which functions as a setup interface. This socket can be used to establish a connection to a PC or Notebook on which the setup program has been installed. The setup program can be used to configure the device, for which there is an extensive range of configuration options.



NOTE!

The setup interface (USB) is not intended to be used for a permanent connection. Always disconnect the USB cable from the device as soon as you have finished working with the setup program.

The length of the USB cable should not exceed 5 m.

It is not possible to establish the connection via a USB hub.

2.7 Timer

The device has a timer. The timer signal can be output via digital outputs or used for internal functional links. A relative timer time can be configured. Following start of the timer via the keypad or a digital signal, a signal is output for the timer runtime. Once the timer has ended, the device provides a timer end signal.

The timer start time can be delayed by setting a lead time. The timer end signal can also be set as infinite. With this setting, the timer must be acknowledged in order to be ended.

The timer start time can be delayed through a tolerance band around the setpoint value. Monitoring of the tolerance band during the timer runtime can be configured.

The timer signal to be output can be inverted.



NOTE!

The digital signals are inactive after power ON. No timer values are saved beyond power failure.

2.8 Temperature display

The temperature unit can be set to °C, °F or "none" via a global parameter. Internally, the device always works in °C. After being changed to °F, the device converts all of the values for operation, display, and the interfaces.



NOTE!

The device converts the entire configuration, such that even a configuration set up in °C works that same when changed to °F.

For this, the following parameters are converted when shown on the display:

- Measured value
- Offset
- Setpoint values, setpoint limits, switching differentials, proportional band
- Limit values, switching differential
- Tolerance band

If the parameter is configured to "none", the icons for °C and °F are hidden on the display. (purely for timer applications).

For all variables for which the unit is clearly a temperature, this is known to the firmware. There is no configuration setting. For variables that the device is unable to clearly assign as a temperature value, the unit is set by a "temperature none/relative/absolute" configuration parameter.

The device always selects the correct, appropriate unit for showing the measured value on the display.

2.9 Limit value monitoring

This function can be used to monitor any analog signal with different switching functions. All in all, there are 8 alarm functions (AF) with different switching characteristics stored on the device.

The switching functions are split into:

- Setpoint-related switching functions (limit value based on the setpoint)
- Limit-value-related switching functions (absolute limit value)

For the limit value monitoring function, the following additional functions are also available:

Switch on/off delay	<ul style="list-style-type: none"> • After the AF event has occurred, the switch-on delay starts to elapse; the AF output remains unchanged • After the switch-on delay has elapsed, the AF event is passed on to the AF output • If the AF actual value goes out of the "invalid range" during this delay time, the time countdown restarts each time the value goes beyond the limit value • Switch-off delay (behavior similar to switch-on delay) 	
Pulse function	<ul style="list-style-type: none"> • The AF output is automatically reset if the value goes beyond the limit value after the set pulse time • If the AF actual value goes into the "valid range" during this time, the pulse time is reset • The pulse function has priority over the switch-off delay; a programmed switch-off delay has no effect 	
Startup alarm suppression	OFF	The alarm function is always active. The limit value exceedance is also immediately transmitted to the output signal in the switch-on phase or in the event of parameter changes
	ON	The AF output only becomes active when the "valid range" has been reached for the first time. If, for example, the setpoint value is changed or the device is switched on, the limit value exceedance is not transmitted to the output signal.
Lock	OFF	Lock is not active: <ul style="list-style-type: none"> • The AF output is reset as soon as the AF event no longer applies
	ON	Lock is active: <ul style="list-style-type: none"> • The AF output is retained, even if the AF event no longer applies • The AF output can only be acknowledged if the AF event no longer applies • Acknowledgement via: keypad, binary signal
	Always acknowledgeable	Lock is active: <ul style="list-style-type: none"> • The AF output can always be acknowledged • Acknowledgement via: keypad, binary signal

2 Description

3 Acceptance of goods, storage, and transport

3.1 Checking the delivery

- Ensure that the packaging and its contents are undamaged.
- Check the delivery for completeness against the packing slip and order details.
- Inform the supplier immediately if there is any damage.
- Store damaged parts until clarification is received from the supplier.

3.2 Important information about storage and transport

- Store the device in a dry, clean environment. Observe the admissible ambient conditions (see "Technical data")
- Protect the device from shock during transport
- The original packaging provides optimum protection for storage and transport

3.3 Returning goods

If repairs are needed, return the complete device in clean condition.

Use the original packaging to return goods.

Accompanying letter for repair

Please include the completed accompanying letter for repair when returning goods.

Do not forget to state the following:

- Description of the application and
- Description of the error that has occurred

The accompanying letter for repair (supplementary sheet for product returns) can be downloaded online from the manufacturer's website:

<http://productreturn.jumo.info>

Protection against electrostatic discharge (ESD)

(ESD = electrostatic discharge)

To prevent damage due to ESD, electronic modules or components must be handled, packaged, and stored in an ESD-protected environment. Measures that protect against electrostatic discharge and electric fields are described in DIN EN 61340-5-1 and DIN EN 61340-5-2 "Protection of electronic devices from electrostatic phenomena".

When sending back electronic modules or components, please note the following:

- Pack sensitive components only in an environment providing protection against ESD. Workspaces such as this divert electrostatic charges to ground in a controlled manner and prevent static charges due to friction.
- Use only packaging intended specifically for ESD-sensitive modules/components. These must consist of conductive plastics.

No liability can be assumed for damage caused by ESD.



CAUTION!

Electrostatic charges occur in non-ESD-protected environments.

Electrostatic discharges can damage modules or components.

- ▶ For transport purposes, use only the ESD packaging provided.
-

3 Acceptance of goods, storage, and transport

3.4 Disposal

Disposing of the device



DISPOSAL!

Devices and/or replaced parts should not be placed in the refuse bin at the end of their service life as they consist of materials that can be recycled by specialist recycling plants.

Dispose of the device and the packaging material in a proper and environmentally friendly manner.

For this purpose, observe the country-specific laws and regulations for waste treatment and disposal.

Disposing of the packaging material

The entire packaging material (cardboard packaging, inserts, plastic film, and plastic bags) is fully recyclable.

4.1 Installation instructions



WARNING!

The device is not designed for use in potentially explosive areas.

Explosion hazard.

- ▶ Only deploy the device outside of potentially explosive areas.

Mounting site

The device is designed for installation in a panel cut-out within a closed switch cabinet. The front of the device and housing have different protection types (see technical data).

Climatic conditions

The ambient temperature and the relative humidity at the mounting site must correspond to the technical data. Aggressive gases and vapors have a negative effect on the operating life of the device. The mounting site must be free from dust, powder, and other suspended solids.

Installation position

The device can be installed in any position.

The maximum admissible ambient temperature only applies for the installation with the display in a vertical position.

Technical data

⇒ chapter 9 "Technical data", Page 61

4 Mounting

4.2 Dimensions

4.2.1 Type 701090

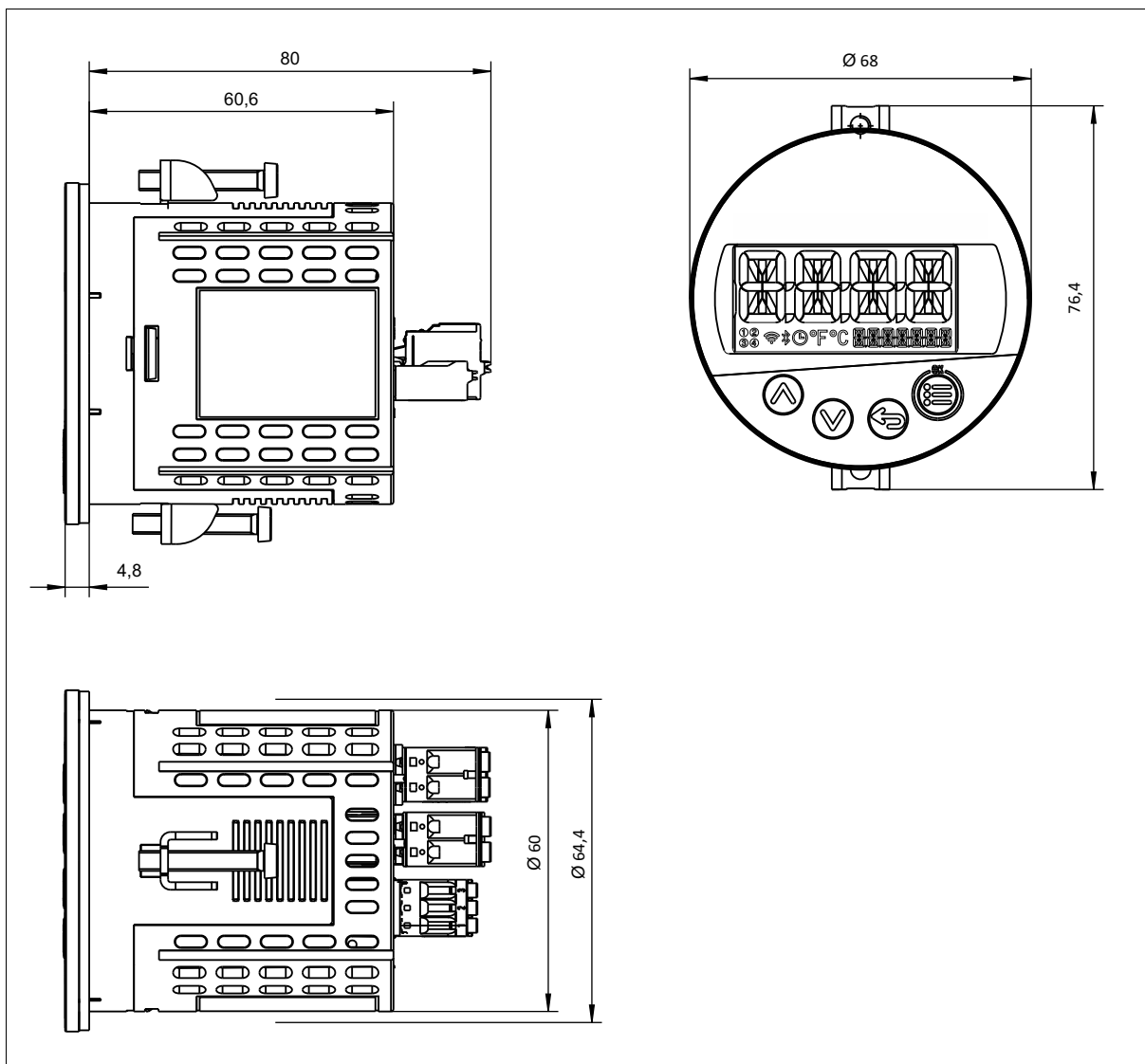

4.2.2 Type 701091

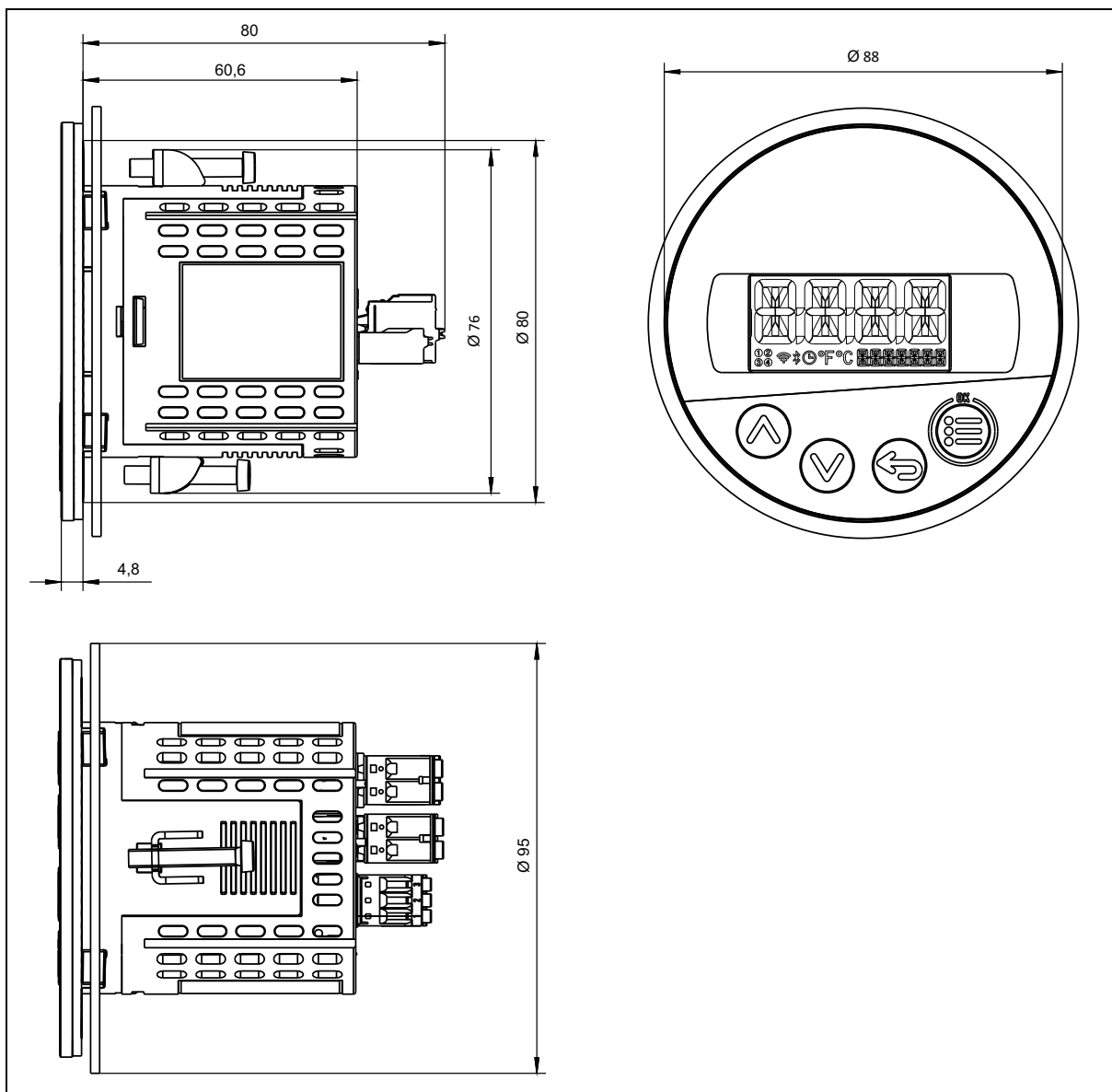

4.2.3 Installation dimensions

Type	Panel cut-out Ø	Mounting depth without seal	Minimum spacing of panel cut-outs (for close mounting)	
			Horizontal	Vertical
701090	60.5 +0.5 mm	80 mm	15 mm	30 mm
701091	80.5 +0.5 mm			

4 Mounting

4.3 Panel mounting



CAUTION!

The front of the device and housing have different protection types!

The protection type IP65 (front-side) is only guaranteed if the seal is flush and even.

- ▶ Use the mounting frame or both mounting elements as shown in the figure and ensure an even attachment!

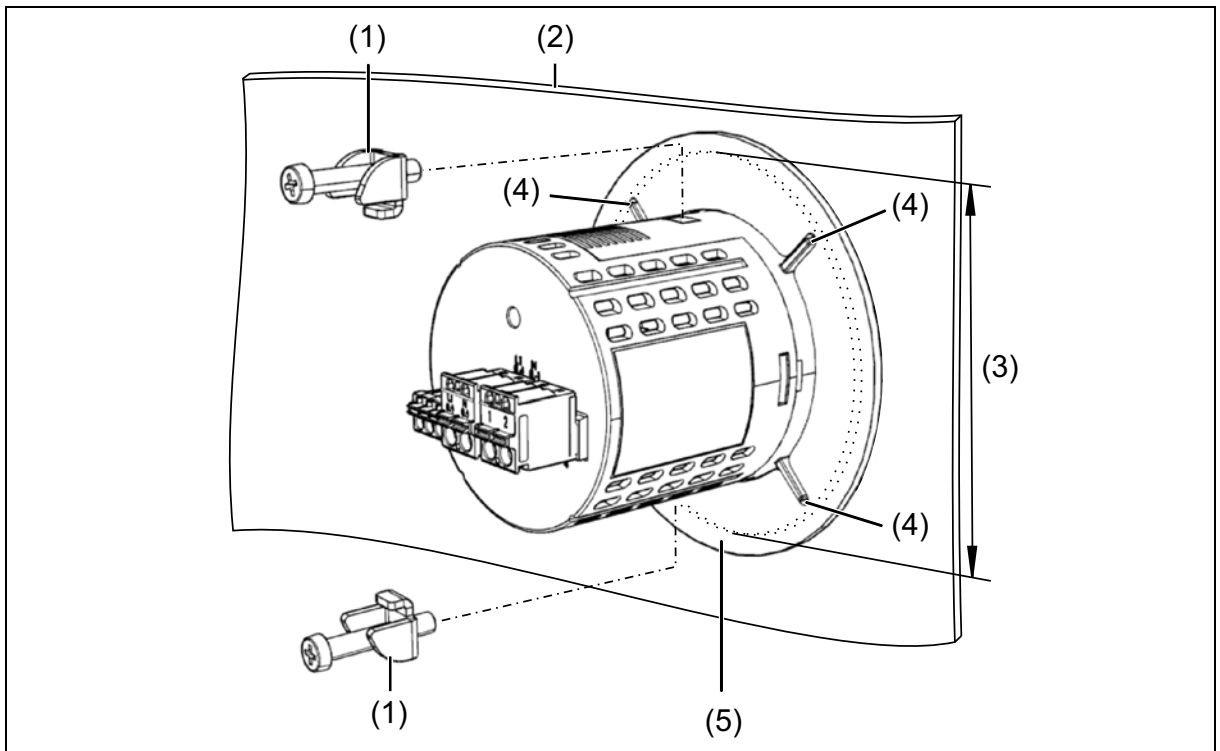

1	Panel fasteners	2	Panel
3	Panel cut-out	4	Supporting lugs
5	Adapter plate		

1. Create panel cut-out (see installation dimensions).
2. Insert the device from the front into the panel cut-out and ensure that the seal is correctly positioned.
3. Only for device with diameter 80 mm: First, on the back of the panel, slide the adapter plate onto the device from behind.
4. Insert the upper panel fastener into the device body and turn the screw in by hand until it reaches the adapter plate.
5. Insert the lower panel fastener into the device body and turn the screw in by hand until it reaches the adapter plate.
6. Tighten both screws with a Phillips screwdriver.

The mechanical installation is completed.

5.1 Installation notes

Requirements for personnel

- Work on the device must only be carried out to the extent described and, like the electrical connection, only by qualified personnel.
- Before plugging and unplugging connecting cables, it must be ensured that the acting person is electrostatically discharged (by touching grounded metallic parts, for example).

Cables, shielding, and grounding

- When selecting the electrical wiring material as well as when installing and connecting the device electrically, comply with the requirements of DIN VDE 0100 "Low-voltage electrical installations" and the applicable country-specific regulations (for example, based on IEC 60364).
- It may be necessary to adhere to special notes relating to the heat resistance of cables (see connection diagram).
- Route input, output, and supply lines separately and not parallel to one another.
- Only use shielded and twisted probe and interface cables. Do not route the lines close to current-carrying components or cables.
- For temperature probes, ground the shielding on one side in the control cabinet.
- Do not perform loopthroughs on the grounding cables, but instead route the cables individually to a shared grounding point in the control cabinet; in doing so, ensure that the cables are as short as possible.
Ensure that the potential equalization is correct.

Electrical safety

- The device is intended to be installed in control cabinets or plants. Ensure that the customer's fuse protection does not exceed 20 A. Disconnect the device from the mains voltage on all poles prior to starting service or repair work.
- The relay's load circuit can be operated with a hazardous electrical voltage (e.g. 230 V). De-energize the load circuit during mounting/dismounting and electrical connection.
- To prevent the relay contacts being destroyed in the case of an external short-circuit in the load circuit, the latter must be fuse-protected as per the maximum admissible relay current (see technical data).
- The device is not suitable for installation in potentially explosive areas.
- In addition to a faulty installation, incorrectly set values on the device can also impair the correct function of the downstream process. Therefore, ensure that safety devices independent of the device, e.g., overpressure valves or temperature limiters/monitors, are present and that it is only possible for qualified personnel to define settings. Please observe the corresponding safety regulations in this context.

References to other information

- The electromagnetic compatibility conforms to the standards and regulations cited in the technical data.
- In general, please observe the specifications regarding electrical isolation.

5 Electrical connection



DANGER!

Risk to life due to electric shock

Risk of injury when touching live parts!

- ▶ Only qualified electricians are allowed to connect and install an electrical device that is not already ready to use.
- ▶ Before working on the system or device, switch off the voltage and secure it so that it cannot switch on again.
- ▶ Do not touch electronic components when they are live.
- ▶ Always observe the relevant accident prevention regulations and safety requirements for electrical devices.

5.2 Connection elements and connectors



NOTE!

Please refer to the sticker on the device for the correct terminal assignment.

As a general rule, use ferrules when connecting stranded cables.

Both device types are equipped with pluggable terminal strips with push-in spring connection. The connections are consolidated by type into four groups:

- 1 - Micro USB (setup interface)
- 2 - Analog input (sensor) and digital input
- 3 - Voltage supply (see nameplate)
- 4 - Digital output (relay)

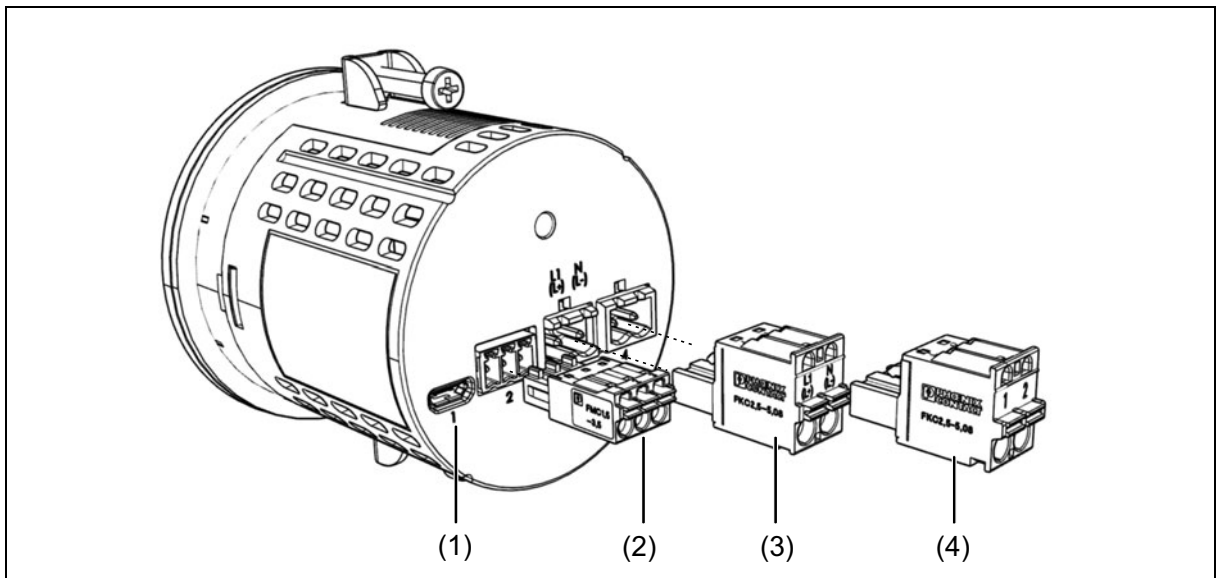

5.3 Connection diagram



CAUTION!

Risk of device damage

If the device is not supplied with the voltage specified on the nameplate, this could cause damage to the device.

- ▶ Only supply voltage from a voltage source that matches the specifications on the nameplate.



CAUTION!

In unfavorable conditions, the temperature may exceed 60 °C at the terminals.

As a result, the insulation of the lines connected at the terminals may be damaged.

- ▶ The affected cables must be heat-resistant up to at least 80 °C.
- ▶ Relay (16 A): the affected cables must be heat-resistant up to at least 95 °C.



NOTE!

Only copper conductors are allowed to be connected to the terminals.

5.3.1 Type 701090 (Ø 60) and Type 701091 (Ø 80)

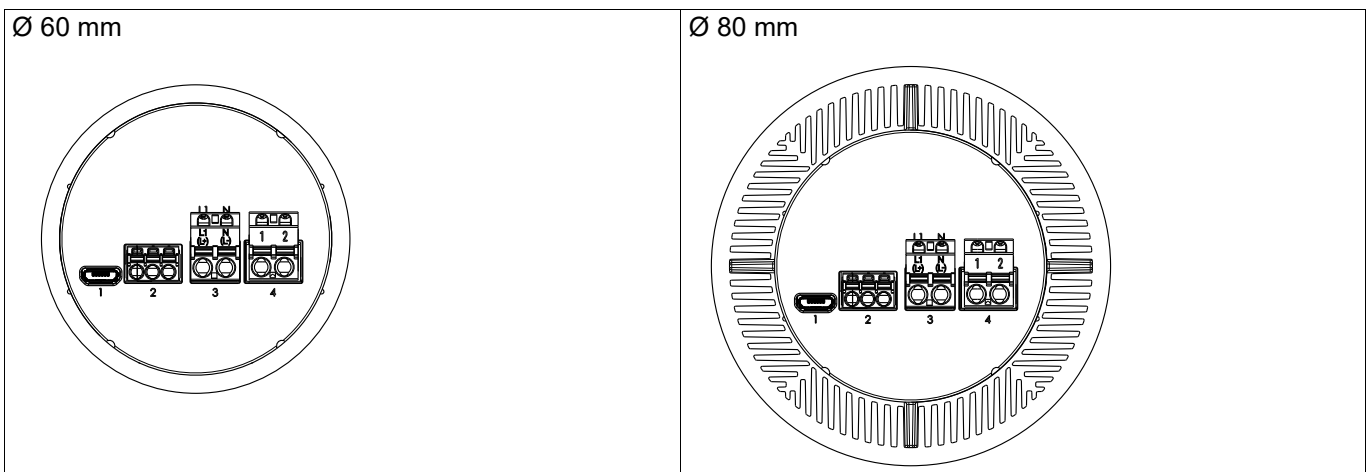

Terminal strip 2 Analog input, digital input

RTD temperature probe in two-wire circuit and digital input

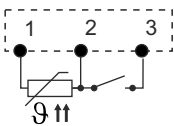

Terminal strip 3 L1(L+), N(L-)

Voltage supply (see nameplate)
AC 230 V, 48 to 63 Hz
or
AC 115 V, 48 to 63 Hz
or
DC 12 to 24 V

Terminal strip 4 Digital output

1 relay normally open contact

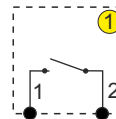

5 Electrical connection

5.4 Galvanic isolation

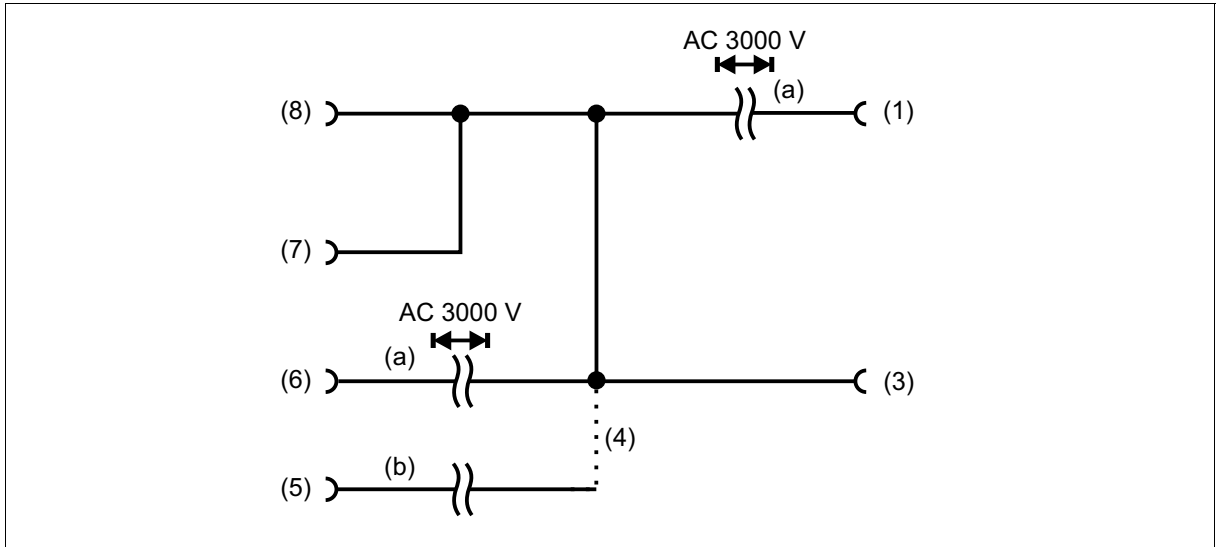

a	The voltage specifications correspond to the test voltages (alternating voltage, rms values) according to DIN EN 61010-1 (VDE 0411-1):2020-03	b	Functional galvanic isolation for connecting SELV or PELV electrical circuits
1	Relay output		
3	USB interface	4	or
5	Voltage supply DC 12 V to 24 V	6	Voltage supply 230 V, 48 to 63 Hz 115 V, 48 to 63 Hz
7	Digital input	8	Analog input



CAUTION!

The analog input and the USB interface are not galvanically isolated.

- ▶ Do not connect the USB with a grounded sensor if the ground of the PC is also grounded (e.g. a desktop PC).

The primary operator interface on the device is the front side membrane keyboard with the display. It enables users to quickly operate and configure the device at the device installation location. Non-relevant parameters, sub-parameters, selector and selection settings are hidden by the software for operation of the device if

- the device does not have the hardware,
- the option is not enabled,
- the function is switched off,
- the function does not match the parameter.

The individual parameters for device setting are organized in different levels that can be inhibited. A level inhibit helps to prevent accidental or unauthorized operation.

As soon as a value can be edited, it starts flashing on the display. If you click the "OK/Menu" key, the device accepts the set value. You can abort the process and retain the old value by pressing the "BACK" key.

The 30-day test version of the setup program allows you to easily configure the device using a PC. The following functions can only be configured with the setup program.

- User level
- Customer-specific linearization

The setup program is available to download. The license number for the full version of the setup program is available for a fee and can be requested from your sales partner.

6.1 Display and control elements

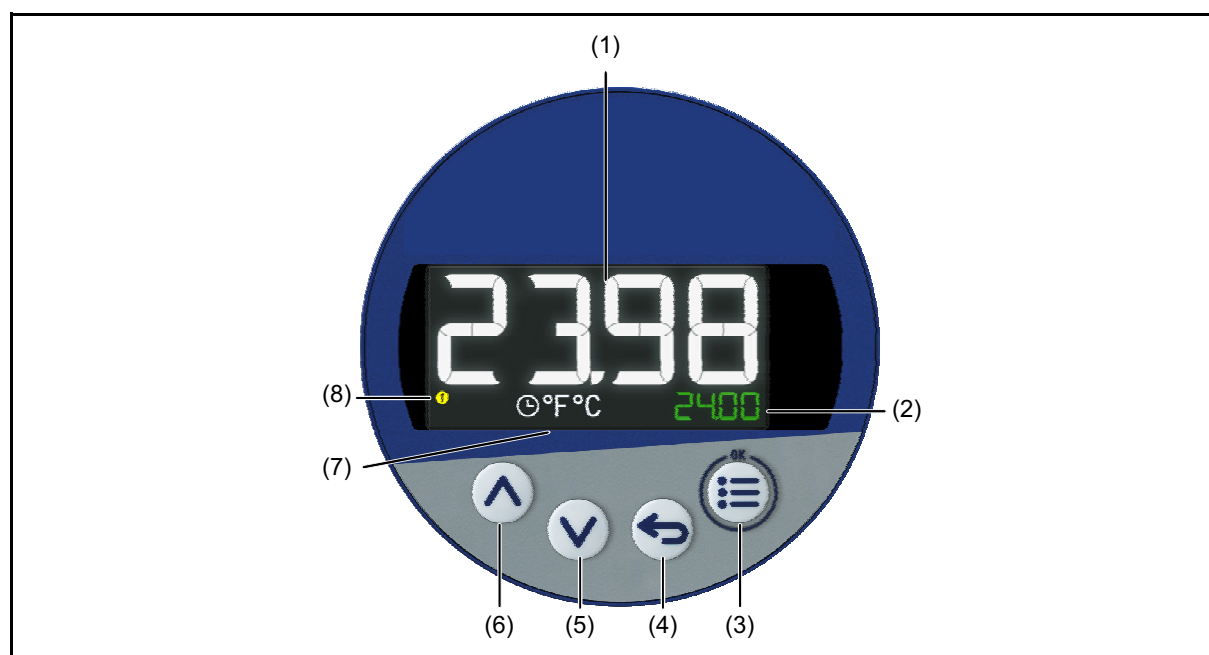

1	Display 1 - 18-segment LCD display (e.g. actual value), 4-digit, white; also for displaying menu items, parameters and text	2	Display 2 - 18-segment LCD display (e.g. setpoint value), 7-digit green; also for displaying menu items, parameters, values, and text
3	Menu/OK (call up main menu, switch to sub-menu/level, switch to editing mode, exit editing mode with change)	4	Back (in menu: back to previous menu level, exit editing mode without change; in basic status: configurable function)
5	Down (in the menu: reduce value, select next menu item or parameter; reduce setpoint value or, in manual mode, output level)	6	Up (in the menu: increase value, select previous menu item or parameter; increase setpoint value or, in manual mode, output level)

6 Operation

7	Timer (illuminated = on, flashing = started), Temperature Unit	8	Switch position of the digital outputs (yellow = active)
---	---	---	---



NOTE!

As display 1 and display 2 are restricted to 4 or 7 characters, menu titles and indicators are displayed as running text. The speed of the running text can be adjusted in the menu > "Configuration/Display/Operation/Running speed" to one's personal requirements.

The text runs when the menu item or the function is called up. Once the text has run all the way through, display 1 remains at the first 4 characters. The text in display 2 continues running as long as the text is longer than 7 characters.

If the function from display 2 is selected with the Menu/OK key, the display flashes.







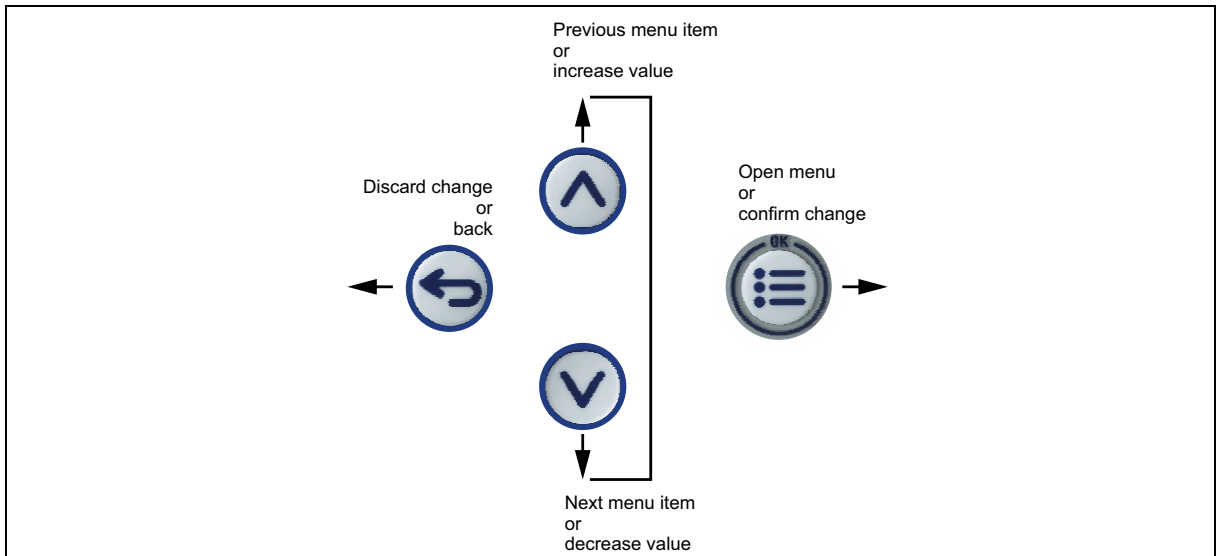

The display stops flashing when the function is aborted with the "Back" button or selected/confirmed with the "Menu/OK" key.

6.1.1 Operating overview

Navigation



Button functions

Button or button combination (permanent)	In basic status	Function	
		When navigating	When editing
Up 	Increase setpoint value In manual mode: increase output level	Select previous menu item or parameter	Increase value or go up in picklist
Down 	Decrease setpoint value In manual mode: reduce output level	Select next menu item or parameter	Decrease value or go down in picklist
Back short (< 3 s) 	Function configurable (default setting: no function)	Move to menu level above	Leave editing mode without changes
Back long (> 3 s) 	Function configurable (default setting: without function)	---	---
Menu/OK short (< 3 s) 	Call up main menu	Call up sub-menu or switch to editing mode	Leave editing mode with changes
Up + Down long (> 3 s)  + 	Start/stop autotuning	---	---
Down + Menu/OK very long (> 5 s)  + 	Call up menu for level inhibit	---	---

6 Operation

6.1.2 The level concept

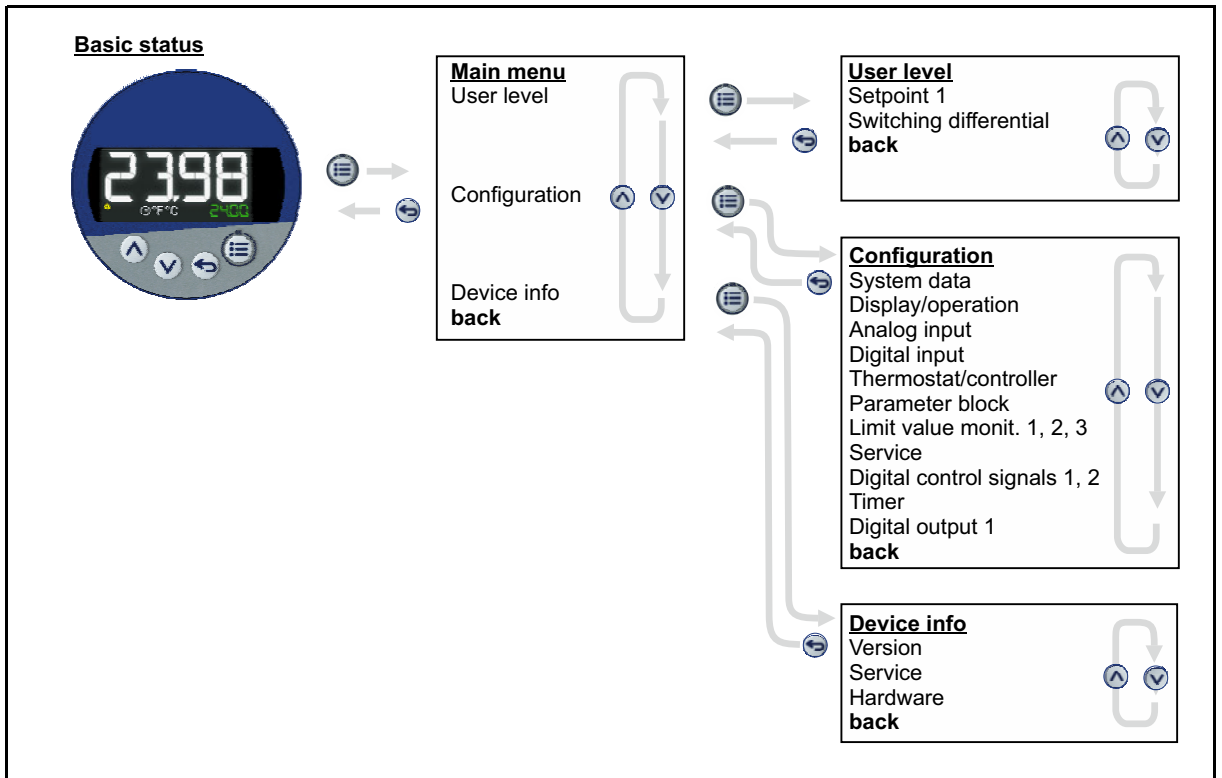

6.2 Device response when switching on

Once the voltage supply is switched on, the controller first starts a test routine. All of the segments on the display briefly light up. Then the device displays the currently configured settings.

These are:

- the measured temperature,
- the setpoint value,
- the displayed measurand (°C/°F),
- the symbol for the timer function (if activated),
- if applicable, the symbol of the controlled outputs.



NOTE!

The device saves the configured display values. If the voltage supply to the device was interrupted and re-established, the device displays the previously parameterized values.

If a start-up delay is configured, the remaining running time of the start-up delay is shown in the 1st display, and "WAIT" appears in the 2nd display.

6.3 Handling input errors

Operating level input errors via device buttons

The software checks the value range and length of input values in the operating level. Invalid values are not accepted.

Checking values of configuration data

A potential error source can be the input and specification of incorrect configuration and parameter data.

- The device software checks the value range all of the entries on the device upon data transfer (keypad, setup interface).
- The setup program itself checks the value range of entries and disallows the input of implausible values.

The device software does not carry out a full plausibility check if, within the configuration level, data is input via the device keypad or the setup program.



NOTE!

The person who carries out the configuration should first plan how the device is to be configured and then carry out the configuration carefully.

Retrospective changes should be performed by a person who can assess the effects on other configuration parameters and program settings.

6.4 Language selection

After switching on the device for the first time, the user can either confirm the flashing displayed language with "OK" or select another language using the "Up"/"Down" buttons and then confirm this with "OK".

After applying a language, the device automatically sets this parameter to "OFF", meaning that language selection is not necessary the next time the device is switched on.

If, at a later point, another user is also to have the option of selecting a language, the configuration parameter "LANGUAGE SELECT. POWER ON" can be set to "ON" in the menu (Configuration > System data).

The language of the device texts can be changed at any time in the configuration settings. This is irrespective of the language selection after switching on the device.

6 Operation

6.5 Basic status

Following "power on" and initialization, if applicable with a configured start-up delay, the device reaches the basic status.

Default setting:

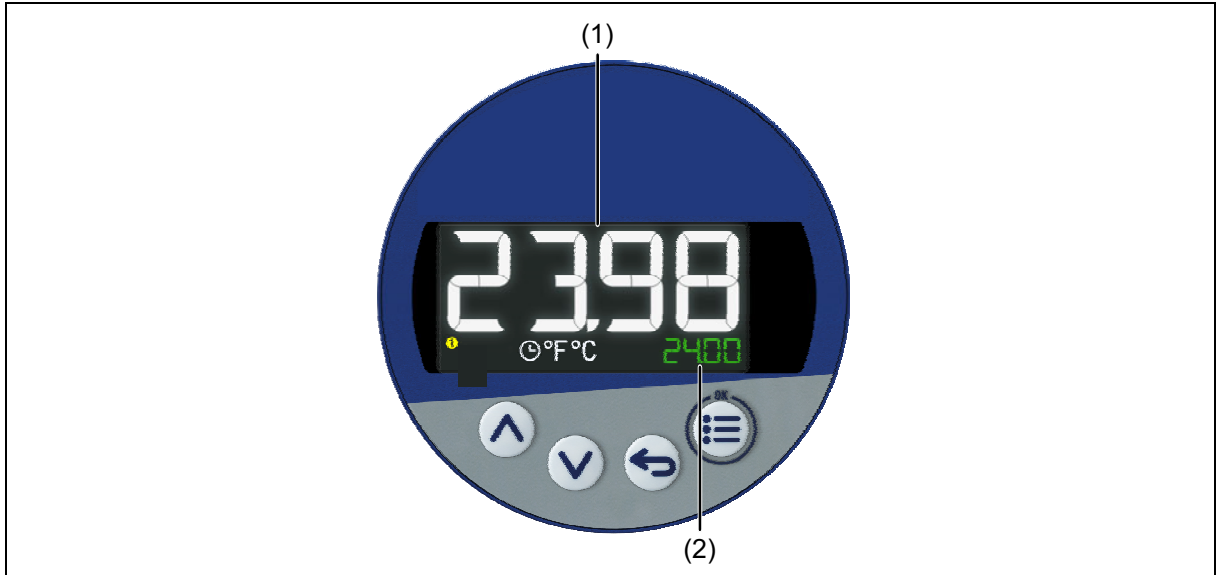

1	Display 1 - analog input	2	Display 2 - 1st setpoint value
---	--------------------------	---	--------------------------------

Timer runtime/timer remaining running time

If the timer is on and the function "Change display upon timer start" has been configured, display 2 shows the previously finished timer runtime or the remaining running time.

6.6 User level

Any of up to 8 parameters can be selected via the setup program. In the default setting, the first setpoint value and the switching differential are preset and can be changed using the buttons on the device.

Changing the setpoint value in the user level:

1. Press OK/Menu button twice.
*Display 1 shows "1st SETPOINT VALUE",
Display 2 shows the currently parametrized setpoint value.*
2. Press OK/Menu button once.
The setpoint value flashes.
3. Adjust the desired setpoint value by pressing the "Up"/"Down" button.
4. Press OK/Menu button once.
The setpoint value is set.

Changing the switching differential in the user level:

1. Press OK/Menu button twice.
*Display 1 shows "1st SETPOINT VALUE",
Display 2 shows the currently parametrized setpoint value.*
2. Press the "Down" button once.

3. Press OK/Menu button once.
*Display 1 shows "SWITCHING DIFFERENTIAL",
 Display 2 shows the currently parametrized switching differential.
 The numeric value of the switching differential flashes.*
4. Set the desired switching differential by pressing the "Up"/"Down" button.
 Press OK/Menu button once.
The switching differential is set.

6.7 Level inhibit

Access to the individual levels can be inhibited. To activate the level inhibit, press and hold the "Menu/OK" and "Down" buttons at the same time for longer than 5 seconds.

The desired degree of inhibition can be selected using the "Up" and "Down" buttons and confirmed using the "Menu/OK" button.

Inhibited levels
NONE (all levels free; default setting)
CONFIGURATION
COMPLETE (USER LEVEL, CONFIGURATION, DEVICE INFO)

When the configuration is locked, it is also not possible to reset the device to the default setting (Device info > Service > Default setting).

6.8 Autotuning – only with controller function

If the device is operated as a two-state controller, autotuning can be started and stopped either manually on the device, or via a digital signal (positive edge).

Manually starting autotuning:

1. Press and hold "Up" and "Down" simultaneously (>3 s).
 - a) The 2nd display shows "AUTOTUNING".

Autotuning has started.

Manually cancelling autotuning:

1. Press and hold "Up" and "Down" simultaneously (>3 s).
 - a) The display returns to the basic status.

Autotuning has ended.



NOTE!

If the controller is switched to manual mode or the actual value goes into "Out of Range", the device cancels the autotuning process. When autotuning is cancelled, the device retains the set parameters.

Optional settings:

- Deactivating optimization of the cycle time by entering a parameter.
- Locking the autotuning function in the configuration.
- Configuring the controller output type that is to be optimized via a parameter.
 (Relay or solid state/logic)

6 Operation

6.9 Manual mode – only for controller function

Manual mode is only possible if the device is operated in the controller function. After the changeover to manual mode, either the current output level or a specific, adjustable output level is displayed and output (configurable).

During manual mode, "MANUAL MODE" flashes in the 2nd display, alternating with the manual output level. The "Up" and "Down" buttons can be used to change the output level.

With the corresponding configuration (Configuration > Display/Operation), the "Back" key can be used to switch to manual mode.

Manual mode can be generally inhibited in the configuration. It is also possible to change over to manual mode, and also to inhibit manual mode, through a digital signal.



NOTE!

The controller automatically changes to manual mode in the event of overrange or underrange, even if manual mode is disabled or inhibited.

6.10 Standby mode

In standby mode, the device controller sets all of the digital outputs to inactive/deactivated and switches the controller off. The device initiates standby mode via a configurable digital signal. If the digital signal = high, standby mode is active.

The device signals standby mode via the flashing 2nd display "STANDBY".

6.11 Time formats

The time format can be configured for the timer function:

MM:SS - Minutes:Seconds

HH:MM - Hours:Minutes

DD:HH - Days:Hours

Time formats on the device are configured in the menu
>CONFIGURATION/TIMER/TIME DISPLAY.

It is only possible to set these when the timer is switched on.

1. Navigate to the CONFIGURATION/TIMER/TIME DISPLAY menu.
2. Press OK/MENU.
The 2nd display with the time format flashes.
3. Use DOWN or UP to select the desired time format.
4. Press OK/MENU.
The 2nd display stops flashing.
5. Press the Back button 3 x to return to the basic display.
The time format for the timer is set



NOTE!

How the individual menu items on the device are displayed always depends on the hardware that is used and on the device function.

7.1 Selectors

The purpose of selectors is to connect the output variables of a device function with the input measurands of another device function. The device differentiates between digital and analog selectors. The selectors contain all of the relevant process values that are present in the device.

Process values that are not present in the present device configuration are hidden by the device.

7.1.1 Digital selector

The digital functions listed below are available for the configuration (digital selector).

Function	Note
No selection	
Digital input	
Thermostat output	
Controller output	Only with extra code "PID two-state controller"
Limit value output 1	
Limit value output 2	
Limit value output 3	
Timer output	
Timer tolerance band signal	
Timer end signal	
Timer stop signal	
1st digital control signal	
2nd digital control signal	
Service signal	
Short return key <3 s	
Long return key >3 s	

7 Configuration

7.1.2 Analog selector

The following list of analog functions are available to select from in the configuration (analog selector).

Function	Note
No selection	
Analog input	
Setpoint value 1	
Setpoint value 2	
Current setpoint value	
Controller output	Only with extra code "PID two-state controller"
Output level display	
Timer runtime	
Timer remaining running time	
Timer value	
Service counter	Not configurable for display 1
Operating time	

7.2 Setup program

The setup program helps users to easily configure the devices. It comes with the following language options: German, English, French, and Spanish.

The setup program can be used to create the configuration data of the devices, save them in a file, and transfer them to the device. It is also possible to extract the configuration data of the device. Data is transferred serially using the USB interface (setup interface). The data can be printed off for use as system documentation.

A 30-day test version of the setup program is available for download. The license number for the full version is available for a fee and can be requested from your sales partner.

7.2.1 Online parameters

An active connection between the setup program and the device is required for executing these functions.

Fine adjustment

You can use this function to correct the measured values of the analog input. In contrast to measured value offsetting, which is used to specify a constant correction value for the entire characteristic line, fine adjustment can also be used to change the gradient of the characteristic line.

This function is identical to the fine adjustment in the device (see configuration of the analog input).

Approval of extra codes

You can use this function to activate additional functions (extra codes) for the device via the setup program.

Action	Version	Description
Generate code number	To generate a code number, click the function to select it and then click the "Next" button. Follow the other instructions.	This function is used to generate a code number to activate an extra code. The code number is required to obtain an activation code from a sales partner.
Enter activation code	To enter an activation code, click the function to select it and then click the "Next" button. Follow the other instructions.	This function is used to activate an extra code. This requires the activation code received from the sales partner.
Reset extra codes	To reset extra codes, click the function to select it and then click the "Next" button. Follow the other instructions.	This function can be used to lock an extra code that has been activated. Locked extra codes can only be activated by re-enabling. This procedure is subject to charge.

Calibrate/test

The following functions are available in this menu:

- **Hardware/software:** This window displays the hardware and software status of the device.
- **Calibration constants:** This window displays the calibration constants of the analog input.
- **Analog input:** This function tests the analog input. For this, the signal or sensor must be connected to the analog input.
- **Digital input:** This function displays the logical status at the digital input. Any inversion activated in the configuration is not considered.
- **Digital outputs:** This function is used to set the logical statuses at the digital outputs. Any inversion activated in the configuration of the respective digital output is not considered.
- **Display:** This function is used to activate or deactivate all display elements of the device.
- **Keypad:** This function checks all the keys on the device. After pressing "Read keys", each press of a key on the device is shown by a red circle around the corresponding key in the setup program.

7 Configuration

7.2.2 Start-up parameters

The start-up function allows the visualization and recording of process values in real time. This considerably simplifies the startup of a system, for example. The maximum recording duration is 24 hours. The files that are created when the data is recorded can be saved and printed out.

Process values

Up to 13 process values for the visualization, recording, and display in the online data window of the setup program are selected in this window ("Process values for start-up" tab). These are analog and digital signals from the selectors.

Display

This window displays the selected process values as a line chart (analog curve or digital trace).

Various functions are available via a context menu (right mouse button):

- Zoom function
- Print function
- Setting channel properties (process values) for the visualization
- Setting diagram properties
- Setting input signals (according to the function under "Process values")
- Starting and stopping recording (active connection between the setup program and the device required)
- Loading recorded measurement data for the visualization

Protocol

This function is used to log and print the recorded diagram (startup protocol).

There are some text entry fields that can be used for the description at the bottom edge of the diagram. Alternatively, the texts from the file info of the setup file can also be used here. There is also one field for the date (editable) and one for the signature.

There is a print function, incl. print preview and printer selection, available via a context menu (right mouse button). The features for the protocol to be printed are also defined here (page margins, line type, use of texts from the file info header).

7.2.3 Customized linearization

The user can create an individual linearization characteristic line for the analog input with the customer-specific linearization. Two procedures are available for this (type of linearization): formula or grid points (value pairs).

The text entered under "designation" is not used at another point in the setup program, but serves merely as text in the sense of a brief description.

Formula

Linearization is specified using a formula with five coefficients (4th order polynomial).

Polynomial: $y = X4 \cdot x^4 + X3 \cdot x^3 + X2 \cdot x^2 + X1 \cdot x + X0$

Parameter	Selection/text/value	Description
Measuring range start	-1999 to 9999 (0)	Start value of the y axis (linearized value)
Measuring range end	-1999 to 9999 (100)	End value of the y axis (linearized value)
X0	-1999 to 9999 (0)	Absolute component of the polynomial (point of intersection with the y axis)
X1	-1999 to 9999 (0)	Coefficient of the linear component (x)
X2	-1999 to 9999 (0)	Coefficient of the quadratic component (x ²)
X3	-1999 to 9999 (0)	Coefficient of the cubic component (x ³)

Parameter	Selection/text/value	Description
X4	-1999 to 9999 (0)	Coefficient of the quartic component (x^4)

"Display graphic" button (displaying linearization on a graphic):

Use this button to create a graphic of the linearization.

The graphic includes the characteristic lines for both types of linearization where applicable, namely the formula and the grid points (table).

The display range for the graphic is initially determined by the "measuring range start" and "measuring range end" values (y values); it can be temporarily changed in the display by entering different x values.

Grid points

Linearization is specified by entering up to 40 grid points (pairs of values X,Y). The value X stands for the physically measured value (resistance in Ω or voltage in mV) for a RTD temperature probe or thermocouple. With the other signal types, the input variable is scaled to 0 to 100% (for voltage/current signal of measuring range, for resistance/potentiometer of resistance Rx, for resistance transmitter of overall resistance). The value Y is the linearized value (e.g., temperature in $^{\circ}\text{C}$).

Parameter	Selection/text/value	Description
Measured value (X)	-1999 to 9999 (0)	Value of the relevant grid point on the x axis
Linearized value (Y)	-1999 to 9999 (0)	Value of the relevant grid point on the y axis

 button (calculating the polynomial using the grid points):

After entering the value pairs, use this button to calculate a polynomial that describes the progression of the linearization characteristic line.

The calculated coefficients are incorporated into the formula. The characteristic lines for both types of linearization then correspond to each other.

If the x values do not increase in a straight line, the linearization is not applied. In this case, it is impossible to display the graphic or calculate the polynomial.

"Display graphic" button (displaying linearization on a graphic):

Use this button to create a graphic of the linearization.

The graphic includes the characteristic lines for both types of linearization where applicable, namely the grid points (table) and the formula.

The display range for the graphic is initially determined by the smallest and largest grid points; it can be temporarily changed in the display by entering different x values.

7 Configuration

7.3 Configuration – Menu

7.3.1 System data

System data with the setup program and on the device

The basic settings of the device can be specified in this menu.

Parameter	Value	Default setting	Description
Device name	<Device name> (editable)	<Name>	Device designation (in the "Device information" menu)
Language	German	German	National language of display texts
	English		
	French		
	Spanish		
Language select. aft. Power-On		Off	Language selection after switching on the next time
	Off		Selecting "Off" means that language selection is not necessary the next time the device is switched on. After selecting a language, this parameter is automatically set to "No".
	On		If "On" is selected, the user can select the language for the device texts the next time the device is switched on - following the change to the configuration.
Temperature unit	Deg. Celsius	Deg. Celsius	Temperature unit for the display on the device and in the setup program (automatic conversion from °C to °F)
	Deg. Fahrenheit		
	None		
Standby	Digital selector, see page 35	No selection	This signal puts the device into standby mode

7.3.2 Display and operation

Display/operation with the setup program

The settings for the display/operation of the device are specified in this menu.

Parameter	Value	Default setting	Description
Display			
Display 1	Analog selector, see page 36	Analog input	Display value of the upper LED display (white)
Message text 1	(editable)		Is displayed as soon as the message text 1 signal accepts the logic level "1". Is not displayed if the message text 1 signal accepts the logic level "0".
Message text 1 signal	Digital selector, see page 35	No selection	Setting for which value is to trigger message text 1.
Display 2	Analog selector, see page 36	Setpoint value 1	Display value of the lower LED display (green)
Message text 2	(editable)		Is displayed as soon as the message text 2 signal accepts the logic level "1". Is not displayed if the message text 2 signal accepts the logic level "0".
Message text 2 signal	Digital selector, see page 35	No selection	Setting for which value is to trigger message text 2.
Display change upon timer start		Timer remaining running time	Display changes when timer is started
	No function		No display change
	Timer remaining running time		Display of the remaining running time
	Timer runtime		Display of the runtime
Run speed	0 to 4	4	"4" corresponds to the fastest running speed
Operation			
Short-press back button (< 3 s)	No function Display timer value Start manual mode Start autotuning	No function	Function of the "Back" button in the basic status when short-pressing the button (less than 3 seconds) Additional functions of the button can be selected in the configuration of the individual device functions (digital selector, see page 36).
Long-press back button (> 3 s)		No function	Function of the "Back" button in the basic status when long-pressing the button (longer than 3 seconds)
Operation timeout	0 s, 30 to 180 s	180 s	Time period (in seconds), after which the device automatically returns to the basic status if no key is pressed.
Auto save	No (empty)	No (empty)	The "Menu/OK" button must be pressed to exit editing mode with the acceptance of a change.
	Yes (check)		Editing mode is automatically exited after a certain time and a change is accepted

7 Configuration

Parameter	Value	Default setting	Description
Setpoint value adjustment	Yes (check)	Yes (check)	The current setpoint value can be entered directly in the basic status using the "Up" and "Down" buttons
	No (empty)		Setpoint value adjustment is not allowed in the basic status.
Start delay time	0 to 300 s	0 s	Start delay time (in seconds) after Power ON. All functions of the device are only active after this time has elapsed.
Level inhibit 		None	Access to the individual levels can be inhibited:
	None		No level inhibited
	Configuration		Configuration level inhibited
	Complete		Configuration level and user level locked

Level inhibit

See chapter chapter 6.7 "Level inhibit", Page 33

Display/Operation on the device

The following settings for display/operation can also be carried out on the device.

Parameter	Value	Default setting	Description
Display 1	Analog selector, see page 36	Analog input	Display value of the upper LED display (white)
Display 2		Setpoint value 1	Display value of the lower LED display (green)
Display change upon timer start	No function Timer remaining running time Timer runtime	No function	Is used on the device and in the setup program.
Short-press back button (< 3 s)	No function Display timer value	No function	Function of the "Back" button in the basic status when short-pressing the button (less than 3 seconds) Additional functions of the button can be selected in the configuration of the individual device functions (digital selector, see page 36).
Long-press back button (> 3 s)	No function Display timer value	No function	Function of the "Back" button in the basic status when long-pressing the button (longer than 3 seconds)
Time-out Operation	0 s, 30 to 180 s	180 s	If no key is operated after this time, the device reverts to the basic status
Auto save	No Yes	No	Editing mode is automatically exited after a certain time and a change is accepted
Setpoint value adjustment	No	Yes	Setpoint value adjustment is not allowed in the basic status
	Yes		The current setpoint value can be entered directly in the basic status using the "Up" and "Down" buttons

7 Configuration

Parameter	Value	Default setting	Description
Start delay time	0 to 300 s	0 s	The entries do not become effective until after this time
Message text 1 signal	Digital selector, see page 35	No selection	Setting for which signal is to trigger message text 1
Message text 2 signal		No selection	Setting for which signal is to trigger message text 2
Running speed	0 to 4	4	"4" corresponds to the fastest running speed

7 Configuration

7.3.3 Analog input

Analog input with the setup program and on the device

The settings for the analog input of the device are specified in this menu.

The setup program detects which device version is being used.

Parameter	Value	Default setting	Description
Signal type	2L RTD temperature probe	2L RTD temperature probe	Sensor type
Linearization	Pt100 Pt1000	Pt100	Setting of linearization of the connected sensor
	Customer-specific		Customer-specific linearization with 4th order polynomial or grid points (configurable with setup program)
Decimal places		Auto	Number of pre-decimal and decimal places for the numerical display of the measured value
	Auto		For the setting "Auto", the decimal place is automatically adjusted.
	XXXX.		No decimal place
	XXX.X		One decimal place
Measured value offset	-9999.0 to +9999.0	0.0	The entire measuring range is adjusted up or down
Lead wire resistance	0 to 60 Ω	0	Resistive line resistance for two-wire circuit.
Filter time constant	0.0 to 100 s	0.6 s	Time constant (in seconds) for adjusting the digital input filter (0 s = filter off)
Fine adjustment (only on device)	Off	Off	The function for performing fine adjustment is not active. This function is available in the setup program under "Online parameter".
	On		Fine adjustment is active. The following parameters can be input.
Fine adjustment on the device			
Actual Start Value	-9999 to 9999	0.0	Fine adjustment: device measured value at the lower measuring point
Actual end value	-9999 to 9999	100.0	Fine adjustment: device measured value at the upper measuring point
Target Start Value	-9999 to 9999	0.0	Fine adjustment: reference value at the lower measuring point
Target end value	-9999 to 9999	100.0	Fine adjustment: reference value at the upper measuring point

7.3.4 Digital input

Digital input with the setup program and on the device

The settings for the digital input of the device are specified in this menu.

The setup program detects which device version is being used.

Parameter	Value	Default setting	Description
Inversion	OFF	OFF	When "ON", the switching status is inverted.
	ON		

7.3.5 Thermostat

Thermostat with the setup program and on the device

The device settings for the thermostat and controller function are specified in this menu.

The setup program detects which device version is being used.

When the PID two-state controller option is enabled, it is possible to choose between the thermostat and PID two-state controller.

Parameter	Value	Default setting	Description
Controller type	Off	Thermostat	Selection of device function
	Thermostat		
	Two-state controller (2-state controller)		
Function	Heating	Heating	Heating: The thermostat output switches as soon as the setpoint value is undershot
	Cooling		Cooling: The thermostat output switches as soon as the setpoint value is exceeded
Setpoint value 1	-1999.0 to +9999.0	0.0	Value of setpoint value 1
Setpoint value 2	-1999.0 to +9999.0	0.0	Value of setpoint value 2
Min. setpoint value	-1999.0 to +9999.0	-1999.0	Minimum admissible setpoint value
Max. setpoint value	-1999.0 to +9999.0	9999.0	Maximum admissible setpoint value
Setpoint change-over signal	Digital selector, see page 45	No selection	Signal (high-active) for changeover to setpoint value 2
Switching differential	0 to +9999.0 °C	1.0	Hysteresis function
Response in case of a fault	Output off	Output off	State of the output signal in the case of a fault
	Output on		
Min. ON period	0 to +9999.0 s	0.0 s	Minimum ON period of the output signal
Max. ON period	0 to +9999.0 s	0.0 s	Maximum ON period of the output signal

7 Configuration

7.3.6 Controller

Controller with the setup program

When the "two-state controller" option is enabled, further device settings are specified for the controller function in this menu.

Parameter	Value	Default setting	Description
Controller type	Off		Selection of device function
	Thermostat		Operate the device as a thermostat
	Two-state controller (2-state controller)		Operate the device as a two-state controller
Control direction	Inverse	Inverse	Inverse: The controller output level is positive if the actual value is smaller than the setpoint value (heating).
	Direct	Direct	Direct: The controller output level is positive if the actual value is greater than the setpoint value (cooling).
Setpoint value 1	-1999.0 to +9999.0	0.0	
Setpoint value 2	-1999.0 to +9999.0	0.0	Setpoint 2 appears if the setpoint changeover signal has been configured
Min. Setpoint limit	-1999.0 to +9999.0	-1999.0	Minimum admissible setpoint value (lower input limit)
Max. Setpoint limit	-1999.0 to +9999.0	+9999.0	Maximum admissible setpoint value (upper input limit)
Manual mode	Enabled	Enabled	Changeover to manual mode is possible through key/button operation or a digital signal
	Disabled		Changeover to manual mode is inhibited
Setpoint changeover signal	Digital selector, see 35	No selection	Signal (high-active) for changeover to setpoint value 2
Signal Manual/ Auto changeover		No selection	Signal (high-active) for changeover to manual mode
Signal Manual mode locking		No selection	Signal (high active) for inhibiting manual mode
Y in manual mode		Current value	Output level after changeover to Manual mode
	Y manual mode		Configurable value (see "Y manual mode" parameter)
	Current value		Current output level before changeover
Y manual mode	0 to 100 %	0	Output level (in percent) in manual mode
Y with error		Y replacement value	Output level in the event of a fault (outside of the measuring range)
		Current value	Current output level before fault occurs
		Y replacement value	Configurable value (see "Y replacement value" parameter)
Y replacement value	0 to 100 %	0	Output level (in percent) in the event of a fault
Autotuning			

Parameter	Value	Default setting	Description
Locking (setup only)	Enabled	Enabled	Autotuning is enabled
	Disabled		Autotuning is disabled
Output type Controller		Relay	Type of controller output. The cycle time is calculated on the basis of the type of controller output.
	Relay		Relay output
	Solid state, logic		Logic output
Application of switching period		On	Application of "Cy" cycle time after completion of autotuning
	On		The determined value will be accepted
	Off		The determined value will not be accepted
Start/stop signal	Digital selector, see page 35	No selection	Signal (active for rising edge) for starting and stopping autotuning. Autotuning is started by a rising edge. If autotuning is active, it is stopped by a rising edge.
Autotuning inhibiting		No selection	Signal (high-active) for inhibiting autotuning

Controller on device

If the controller function for the device is enabled and the controller type is configured to two-state controller, all of the settings can also be configured on the device.

7.3.7 Controller parameters

The following table shows the parameters of a parameter block in the case of an activated two-state controller (option). The transmission behavior is specified by the selection of the controller structure and determined by the configuration of the parameters for the proportional band (P component), derivative time (D component), and reset time (I component).

Parameter	Value range	Default setting	Unit	Meaning
Controller structure 1	P, I, PD, PI, PID	PID		Transmission behavior of the controller
Proportional band Pb1	0 to 9999	0	Physical unit of the controller size	Size of the proportional band The controller structure is not effective with $X_p = 0$ (behavior identical to limit value monitoring function).
Derivative time Tv1	0 to 9999	80	s	Influences the differential component of the controller output signal. The greater the derivative time, the more effect the differential component has.
Reset time Tn1	0 to 9999	350	s	Influences the integral component of the controller output signal. The greater the reset time, the less effect the integral component has.



7 Configuration

Parameter	Value range	Default setting	Unit	Meaning
Cycle time Cy1	0 to 9999	20	s	The cycle time should be chosen such that the energy supply to the process is as continuous as possible without overloading the switching elements.
Switching differential Xd1	0 to 999	1	Physical unit of the controller size	Hysteresis for proportional band $P_b = 0$
Working point Y0	-100 to +100	0	%	Working point correction for a P or PD controller (correction value for the output level). If the actual value has reached the setpoint value, the output level corresponds to the working point Y0.
Maximum Output value limit Y1	0 to 100	100	%	Maximum output value limit (only effective if $P_b > 0$)
Minimum Output value limit Y2	0 to 100	0	%	Minimum output value limit (only effective if $P_b > 0$)
Minimum relay switch-on duration Tk1	0 to 9999	0	s	Limitation of the switching frequency

7.3.8 Limit value monitoring

Limit value monitoring function 1 to 3 with the setup program and on the device

The device is equipped with 3 limit value monitoring functions that can be individually configured. The following configuration parameters are available for each of the 3 limit value monitoring functions.

Parameter	Value	Default setting	Description
Function 	No function	No (empty)	
	AF1		Limit value above and below the setpoint value
	AF2		As for AF1, output signal inverted
	AF3		Limit value below the setpoint value
	AF4		As for AF3, output signal inverted
	AF5		Limit value above the setpoint value
	AF6		As for AF5, output signal inverted
	AF7		Fixed limit value independent of the setpoint value
	AF8		As for AF7, output signal inverted
Actual value input	Analog selector, see page 36	No selection	Analog value as actual value (signal to be monitored)
Setpoint value input		No selection	Analog signal as setpoint value (reference signal for AF1 to AF6)
Limit value	-9999 to 9999	0	Admissible deviation (AL) of the actual value
Limit value behavior		Symmetrically	Standard of monitoring band for AF1 and AF2
	Symmetrically		Standard monitoring band, formed by the limit value (AL)
	Non-standard		Non-standard monitoring band, formed by the limit value (AL) and limit value 2 (AL2)
Switching behavior		Symmetrically	Switching differential position around the limit value
	Symmetrically		Switching differential is positioned with half above and half below the limit value
	Non-standard left		Switching differential is below the limit value (typically)
	Non-standard right		Switching differential is above the limit value (typically)
Start-up alarm suppression 		Off	Alarm suppression during start-up phase
	Off		Limit value monitoring function always operates according to its alarm function
	On		Alarm suppression after power on or if limit value or setpoint value is changed
Switch-on delay time	0 to 9999	0	Delay time (in seconds) for activation of the output signal if alarm condition is present
Switch-off delay time	0 to 9999	0	Delay time (in seconds) for deactivation of the output signal if alarm condition is no longer present

7 Configuration

Parameter	Value	Default setting	Description
Pulse time	0 to 9999	0	The output signal is deactivated automatically after this time (in seconds), even if the alarm condition is still present. If the alarm condition occurs again, the function re-starts (edge-triggered).
Response in case of a fault		Output off	Output signal in the event of a fault (e.g. in the case of overrange or underrange)
	Output off		Output signal inactive
	Output on		Output signal active
Lock	Off	Off	Lock is not active. The output signal is reset as soon as the actual value is back in the valid range
	On		Lock is active. Lock can only be acknowledged if the actual value is back in the valid range
	Always acknowledgeable		Lock is active. The lock can always be acknowledged
Acknowledgement signal	Digital selector, see page 35	No selection	Signal (high-active) for acknowledging the output signal in case of locking

Function

For the AF1 to AF6 alarm functions, the final limit value depends on the setpoint value – the entered limit value is added to or subtracted from the setpoint value. The AF7 and AF8 alarm functions work with a fixed limit value which corresponds to the limit value entered.

See chapter 7.3.8 "Limit value monitoring", Page 49

Startup alarm suppression

Function of the startup alarm suppression:

- After power on, the alarm signals for the limit value monitoring function remains inactive, even if the actual value is in the alarm range.
- If the limit value or setpoint value is changed so that the actual value is then within the alarm range, while the actual value is outside of the alarm range, the alarm signal remains inactive.
- The limit value monitoring only starts to operate according to its alarm function again once the actual value has left the alarm range. This means that the alarm signal remains inactive until the actual value returns to the alarm range.

Alarm functions

The following tables show the alarm functions AF1 to AF8 and the position of the hysteresis (non-standard left, standard, non-standard right).

Switching functions in relation to setpoint value

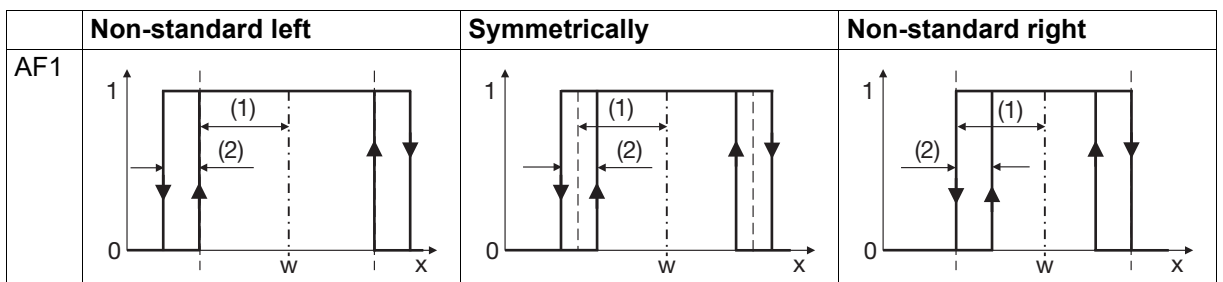

7 Configuration

	Non-standard left	Symmetrically	Non-standard right
AF2			
AF3			
AF4			
AF5			
AF6			

0 = output signal not active

1 = output signal active

x = actual value

w = setpoint value

(1) Limit value (AL)

(2) Hysteresis

Switching functions in relation to limit value

AF7 and AF8 monitor (independently of the setpoint value) whether the actual value exceeds or falls below a fixed limit value.

	Non-standard left	Symmetrically	Non-standard right
AF7			

7 Configuration

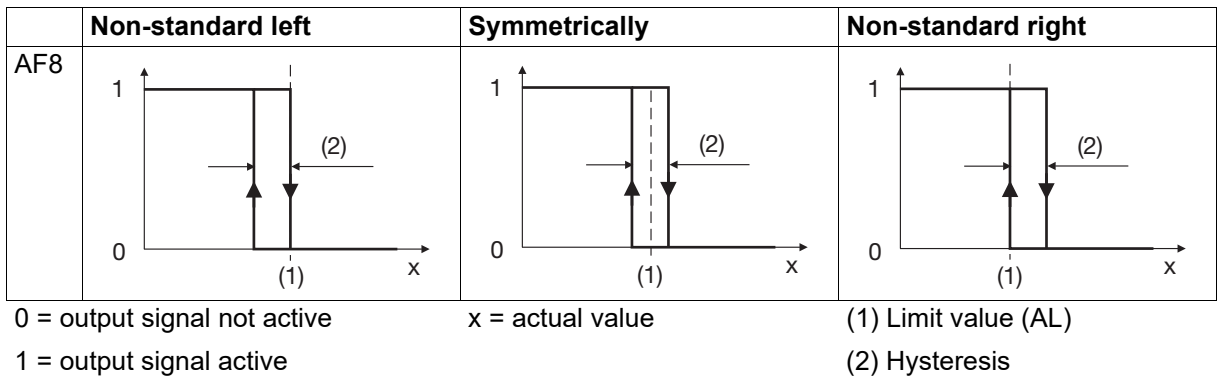

Non-standard switching functions with 2nd limit value

If asymmetric is set for the limit value behavior, AF1 and AF2 monitor whether the actual value x is in an asymmetric window around the setpoint value.

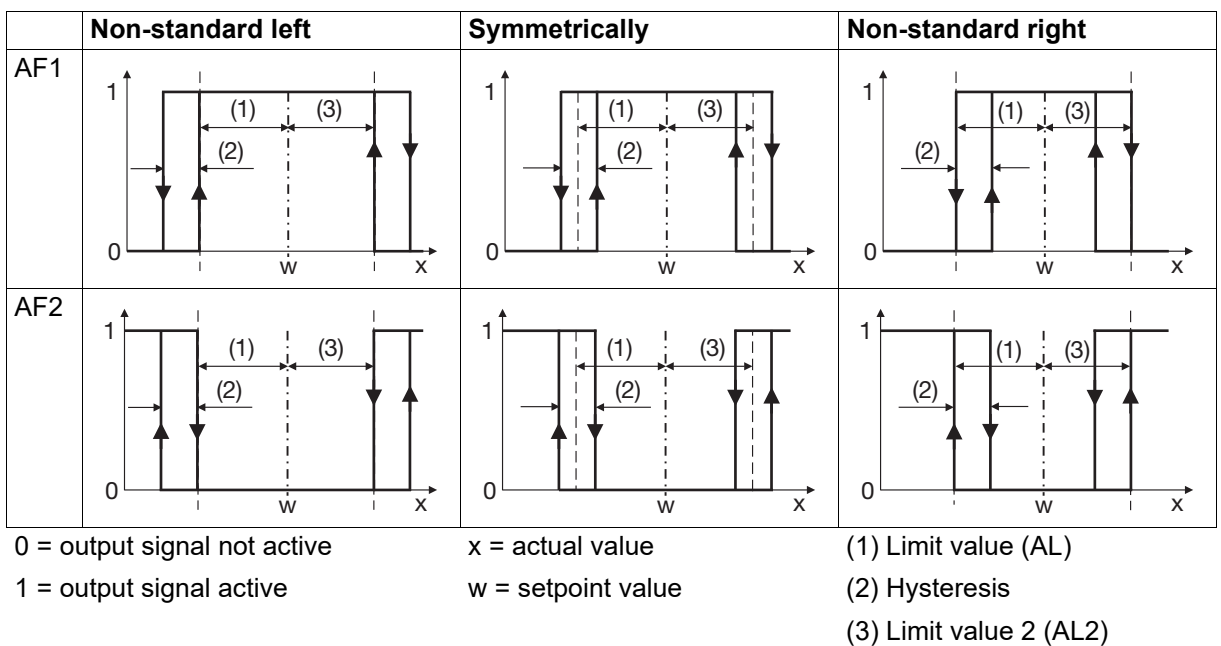

7.3.9 Service

Setting service parameters using the setup program or on the device

The service parameters of the device can be specified in this menu.

All of the parameters can be configured either with the setup program or on the device.

Parameter	Value	Default setting	Description
Function	Number of switch operations	Number of switch operations	Counts the switching frequency of a binary signal
	Time in hours		Counts the switch-on duration of a binary signal in hours
	Time in days		Counts the switch-on duration of a binary signal in hours
Service interval	0 to 10,000,000	0	Adjustable on the device up to 9999 0: Limit value monitoring function switched off >0: limit value monitoring function of the service counter; the device activates the service signal if limit value is exceeded
Signal to be monitored	Digital selector, see page 35	No selection	Binary signal whose switching frequency or switch-on duration is counted
Acknowledgement signal		No selection	Binary signal (high active) to acknowledge the service signal
Operation hours counter	Off	Off	Function is switched off
	Display in hours		The counter is reset to 0
	Display in days		Device operating time in hours Device operating time in days

7.3.10 Digital control signals

With the digital control signals, function blocks are available which can be used to adjust the application. Up to three binary signals can be linked using the AND/OR/XOR function (e.g. setpoint changeover, parameter changeover). Signals can be inverted and delayed. The behavior of the output signal is configurable (pulse).

2 control signals can be programmed. Any binary signal can serve as input (digital selector). The device can output this as follows:

- Inverted
- As a pulse (switch-on time, switch-off time)
- As a delayed switch-on or switch-off operation; (delay time = switch-on time, switch-off time)
- As a pulse signal (pulse time = switch-on time)
- As an AND/OR/XOR function with up to 3 binary signals

Furthermore, it is possible to determine the input signal of the falling edge. For a sampling rate, the output is then set in each case.

NOTE!

The digital control signals are independent of a probe break/short circuit.

The control signals are inactive after power ON.



7 Configuration

Digital control signals with the setup program and on the device

The digital control signals for adjusting applications are specified in this menu.
The setup program detects which device version is being used.

Parameter	Value	Default setting	Description
Function	No function	No function	The output signal corresponds to the input signal (with inverting if necessary)
	Pulse		A pulse-like signal is output as long as the input signal is active (high)
	Delay		The output signal follows the course of the input signal, whereby the transfer from low to high status and vice versa is delayed
	Pulse function		For the rising edge of the input signal, the output signal is activated and deactivated once the pulse time has elapsed (even if the input signal is still active). When the edge of the input signal rises again, the function re-starts
	Rising edge		The output signal is activated for the duration of a cycle interval for the rising edge of the input signal.
	Falling edge		The output signal is activated for the duration of a cycle interval for the falling edge of the input signal
	OR function		Logical OR link of the input signals (signal 1, signal 2, signal 3)
	AND function		Logical AND link
	XOR function		Logical XOR link
Digital signal	Digital selector, see page 35	No selection	Input signal (or OR/AND/XOR signal 1)
2nd signal OR/AND/XOR	Digital selector, see page 35	No selection	Second input signal for the logical link
3rd signal OR/AND/XOR	Digital selector, see page 35	No selection	Third input signal for the logical link
Inversion	No	No	Output signal (control signal) not inverted
	Yes		Output signal (control signal) Inverted
Switch-on time/delay	0 to 9999 s	0	Pulses: Switch-on time (high status; in seconds) Delay: delay time (in seconds) for the transition from low to high status
Switch-off time/delay	0 to 9999 s	0	Pulses: Switch-off time (low status; in seconds) Delay: Delay time (in seconds) for the transition from high to low status

Parameter	Value	Default setting	Description
Pulse time	0 to 9999 s	0	Time (in seconds) for pulse function

7.3.11 Timer

Timer with the setup program and on the device

The settings for the timer are specified in this menu.

The timer and its parameters are not dependent on the device version.

Parameter	Value	Default setting	Description
Function	Off	Off	Timer is not active
	On		Timer is active
Time display		mm:ss	Timer time unit (for input and display on the device)
	mm:ss		Minutes:Seconds
	hh:mm		Hours:Minutes
	dd:hh		Days:Hours
Timer time			Time after timer start The setting range depends on the configured time unit:
	00:00 to 59:59	00:00	mm:ss
	00:00 to 23:59	00:00	hh:mm
	00:00 to 99:23	00:00	dd:hh
Lead time	0 to 9999 s	0	Time before timer start (in seconds)
Timer end time	-1 to 9999 s	0	Time after timer end (in seconds) -1 = infinite, active until acknowledgement The end signal is active during the after-run time.
Acknowledgement signal	Digital selector see page 35	No selection	Only if after-run time ≠ 0: signal (active for rising edge) to acknowledge the end signal
Start signal		No selection	Signal (active for rising edge) to start the timer The start signal only works while the timer is not running or during the after-run time (not during the lead time or runtime)

7 Configuration

Parameter	Value	Default setting	Description
Cancellation signal	Digital selector see page 35	No selection	Signal (active for rising edge) to abort the timer The cancellation signal only works during the runtime (not during the after-run time)
Stop signal		No selection	Signal (high active) for stopping the timer The stop signal only works during the lead time and runtime (not during the after-run time).
Restart signal		No selection	Signal (active for rising edge) to reset and restart the timer The restart signal only works during the runtime (not during the lead time or after-run time); it cannot be used to start the timer The lead time is not considered in case of a restart
Output signal	High active	High active	Output signal: high active while timer is running
	Low active		Output signal: low active while timer is running
Actual value tolerance band	Analog selector see page 36	0	Actual value for tolerance band function
Setpoint value tolerance band		0	Setpoint value for tolerance band function
Tolerance band	0 to 9999	0	Standard tolerance band (in Kelvin) around the setpoint value After the timer is started, the timer time only runs from the point in time when the actual value reaches the tolerance band 0 = Start without tolerance band

7.3.12 Digital output

Digital output with the setup program and on the device

The settings for the digital output of the device are specified in this menu.

The setup program detects which device version is being used.

Parameter	Value	Default setting	Description
Source	Digital selector see page External-Link :	No selection	Signal that is issued at the digital output. In the event of "No selection" the output signal does not correspond to the active status.
Inversion	No	No	Output signal not inverted
	Yes		Output signal inverted

7.4 Device info – Menu

Versions

Device-specific numbers (e.g. fabrication numbers) and version numbers for hardware and software of the device are displayed here.

Service

Here, the counter statuses of the service counter and the operating hours counter, the status of the service signal, and the current error status of the device are displayed.

There is also a function available here for resetting the device to the default setting. By pressing the Menu/OK key (at least 5 seconds), the function is immediately executed.

Hardware

Product group numbers (device type) and information about the device version are displayed here.

7 Configuration

8 Maintenance, cleaning, troubleshooting

8.1 Service

There is a service counter and an operating hours counter in the device. The service counter counts when a signal that has to be monitored is set.

Service counter	The device counts the number of "low-high edges" of a binary signal. For service purposes, the device saves further parameters irrespective of the individual settings: <ul style="list-style-type: none">• Operation time for the service• Terminal temperature• Switching cycles
Operation hours counter	The device measures the switch-on time of a binary signal.
Service interval counter	If the device detects that the service interval (limit value) has been exceeded, it raises the alarm by means of a service signal. If the acknowledgement signal is reset, the service interval counter restarts.
Operating time counter	The device counts the operating hours only if the operating hours counter is set to "Display in hours" or "Display in days". If the operating hours counter is set to "Off", the device resets the counter. The counter counts up to the end of its value range and remains at this point.

8.2 Maintenance

The device is maintenance-free. In the event of damage, e.g. due to transport, maintenance, or faults during operating, it is not permissible to carry out repairs on the device. If the device is opened up, the warranty claim becomes void.

In the event of any damage, send the device to your responsible service partner. See back cover of this operating manual.

8.3 Cleaning

When delivered, the membrane keyboard and the display have a protective film. If the device front becomes dirty during operation, clean the device front with a soft cloth and mild soapy water.



CAUTION!

Risk of damaging the device front!

Cleaning agents such as gasoline, solvents, and abrasive cleaning agent as well as cleaning the device with a high-pressure cleaner can cause irreparable damage to the device front.

- ▶ Always clean the device front with a soft cloth and mild soapy water.

8 Maintenance, cleaning, troubleshooting

8.4 Troubleshooting

8.4.1 Types of errors

Potential types of errors:

- System errors that are detected by hardware or software (e.g. probe break, overrange)
- Fault messages set by the customer in the configuration
(Fault message if the binary input switches from 0 to 1 or if a set limit value is exceeded)
- Runtime error (e.g. division by 0, internal RAM storage faulty, etc.)

8.4.2 Error messages

Display	Possible cause ^a	Measures
<<<<	Measuring range underflow	Check probe and line (break, short circuit, reverse polarity) Check connection terminals Check configuration (signal type, linearization, resistance measuring range, scaling)
>>>>	Measuring range overflow	
++++	Temperature for compensation outside	
----	Probe or line break Probe or line short circuit Not a valid input value Display capacity exceeded invalid value	

^a Depending on the signal type (measuring probe)

In the event of a fault, the controller switches to manual mode.

9.1 Analog input

RTD temperature probe

Designation	Standard	ITS	Connection type	Measuring range	Accuracy ^a	Measuring current
Pt100	DIN EN 60751:2008 IEC 60751:2008	ITS-90	Two-wire	-200 to +600 °C	≤ 0.25 %	500 μA
Pt1000	DIN EN 60751:2009 IEC 60751:2008	ITS-90	Two-wire	-200 to +600 °C	≤ 0.25 %	100 μA
Customer-specific				150 to 3000 Ω	≤ 0.25 %	< 500 μA

^a Accuracy refers to the measuring range.

Ambient temperature influence	≤ 300 ppm/K
Sensor line resistance	Max. 30 Ω per line
Input filter	Digital filter, 2nd order; filter constant can be set from 0 to 100.0 s

Measuring circuit monitoring

The device behavior in the event of a malfunction is configurable.

Measuring probe	Measuring range underflow	Measuring range overflow	Short-circuit (probe/line)	Break (probe/line)	Reverse polarity
RTD temperature probe	++	++	++	++	---
++ = is detected		--- = is not detected		(+) = is detected in certain conditions	

9.2 Digital input

Input for potential-free contact Function	Contact closed: input is active ($R_{ON} < 1 \text{ k}\Omega$) Contact open: input is inactive ($R_{OFF} > 100 \text{ k}\Omega$)
--	---

9.3 Digital output

1 relay (normally open contact) Switching capacity Contact life	Max. 16 A at AC 250 V, resistive load 100,000 switching operations at rated load	Order code 25
---	---	------------------

9 Technical data

9.4 Display

18-segment LCD displays		
Digit height	Upper display: 13 mm	Lower display: 4 mm
Color	white	Green
Places, including decimal places	4	7
Decimal places	0, 1, or automatic (configurable)	

9.5 Electrical data

Voltage supply according to the ordered version	02	AC 230 V -15/+10 %, 48 to 63 Hz		
	05	AC 115 V -15/+10 %, 48 to 63 Hz		
	30	DC 12 to 24 V, -15/+15 % SELV		
Electrical safety	acc. to DIN EN 61010, part 1 Overvoltage category II to 300 V mains voltage, Pollution degree 2			
Power consumption Type 701090 Type 701091	Type AC 230 V: Max. 2.1 W Max. 2.1 W	Type AC 115 V: Max. 3.3 W Max. 3.3 W	Type DC 12 to 24 V: Max. 1.2 W Max. 1.2 W	
Accuracy of timer	1 %			
Sampling rate	250 ms			
Electrical connection	On the back via plug connectors with spring-cage terminals (PUSH IN technology)			
Conductor cross section, mechanical Wire or stranded wire (without ferrule) Stranded wire with ferrule Stripping length	Min. 0.2 mm ² , max. 1.5 mm ² (terminal strips 3 and 4: max. 2.5 mm ²) Without plastic collar: min. 0.25 mm ² , max. 1.5 mm ² (terminal strips 3 and 4: max. 2.5 mm ²) With plastic collar: min. 0.25 mm ² , max. 0.75 mm ² (terminal strips 3 and 4: max. 2.5 mm ²) 8 mm			
Conductor cross section, electric 5 A load current 10 A load current 16 A load current	Min. 0.75 mm ² Min. 1.0 mm ² Min. 1.5 mm ²			

9.6 Environmental influences

Ambient temperature range	
Storage	-30 to +70 °C
Operation	-10 to +55 °C
Site altitude	Max. 2000 m above sea level
Climatic environmental influences	According to DIN EN 60721-3 with extended temperature range
Resistance to climatic conditions	≤ 90 % rel. humidity without condensation
Storage	According to class 1K2
Operation	According to class 3K3
Mechanical environmental influences	According to DIN EN 60721-3
Storage	According to class 1M2
Transport	According to class 2M2
Operation	According to class 3M3
Electromagnetic compatibility (EMC)	Product family standard DIN EN 61326-1
Interference emission	Class B ^a
Interference immunity	Industrial requirement

^a The product is suitable for industrial use as well as for households and small businesses

9.7 Housing

Case type	Plastic case for panel mounting according to IEC 61554 (indoor use), cobalt blue RAL 5013
Case front	Membrane keyboard, upper slope cobalt blue RAL 5013, lower slope silver grey RAL 7001
Panel thickness	1 to 10 mm
Case mounting	In panel using the supplied mounting frame or both mounting elements
Operating position	Any ^a
Protection type	According to DIN EN 60529, IP65 on the front, IP20 on the back
Weight	
Type 701090	Max. 160 g
Type 701091	Max. 240 g

^a The maximum admissible ambient temperature only applies for the installation with the display in a vertical position.

9.8 Approvals and approval marks

Approval mark	Test facility	Certificates/Certification numbers	Inspection basis	Valid for
c UL us	Underwriters Laboratories	E201387	UL 61010-1 (3rd Ed.), CAN/CSA-22.2 No. 61010-1 (3rd Ed.)	All types

The device is approved if the relevant approval mark is pictured on the device.

9 Technical data

JUMO

OneTemp[®] pty ltd
measure | control | record
1300 768 887
www.onetemp.com.au

