



IoT E-ink Display

Featuring LoRaWAN[®]

DS3604

User Guide



Safety Precautions

Milesight will not shoulder responsibility for any loss or damage resulting from not following the instructions of this operating guide.

- ❖ The device must not be modified in any way.
- ❖ In order to protect the security of the device, please change device the password when first configuration. The default password is 123456.
- ❖ Do not place the device close to objects with naked flames.
- ❖ Do not place the device where the temperature is below/above the operating range.
- ❖ Make sure all batteries are newest when install, or battery life will be reduced.
- ❖ The device must never be subjected to shocks or impacts.

Declaration of Conformity

DS3604 is in conformity with the essential requirements and other relevant provisions of the CE, FCC, and RoHS.



Copyright © 2011-2023 Milesight. All rights reserved.

All information in this guide is protected by copyright law. Whereby, no organization or individual shall copy or reproduce the whole or part of this user guide by any means without written authorization from Xiamen Milesight IoT Co., Ltd.

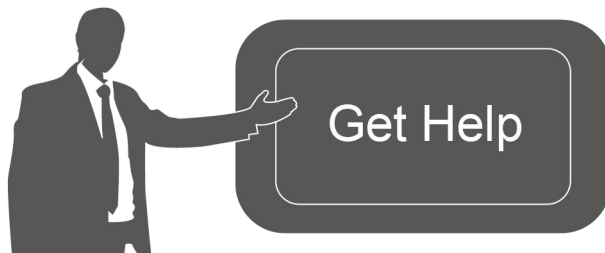

For assistance, please contact

Milesight technical support:

Email: iot.support@milesight.com

Support Portal: support.milesight-iot.com

Tel: 86-592-5085280

Fax: 86-592-5023065

Address: Building C09, Software Park III,
Xiamen 361024, China

Revision History

Date	Doc Version	Description
Feb. 9, 2023	V 1.0	Initial version
May 15, 2023	V 1.1	1. Update button feature; 2. Update button uplink and add button template switch command.

Contents

1. Product Introduction	4
1.1 Overview	4
1.2 Features	4
2. Hardware Introduction	4
2.1 Packing List	4
2.2 Hardware Overview	5
2.3 Dimensions (mm)	5
2.4 Power button and Buzzer Patterns	5
3. Operation Guide	5
3.1 NFC Configuration	5
3.2 LoRaWAN Settings	6
3.2.1 Basic Settings	6
3.2.2 Multicast Settings	9
3.3 General Settings	12
3.4 Display Settings	13
3.5 Maintenance	15
3.5.1 Upgrade	15
3.5.2 Backup	15
3.5.3 Reboot and Reset	16
4. Installation	17
5. Device Payload	18
5.1 Basic Information	18
5.2 Screen Data	19
5.3 Control Commands	19
5.4 Screen Content Update	21

1. Product Introduction

1.1 Overview

DS3604 is a reflective electrophoretic display offering readability and flexibility. The 4.2-inch active area contains 400 x 300 pixels and has 1-bit Black/White/Red full display capabilities. DS3604 supports displaying information in customized templates and allows for secondary development through interfaces. Long-capacity batteries and ultra-low power consumption bring a long battery life of up to 5 years.

DS3604 enables quickly modifying the displayed content remotely and locally through simple operations and allows remote management in bulk. Moreover, DS3604 can be installed in multiple methods and be compliant with standard LoRaWAN[®] gateways and networks for more integrated applications.

1.2 Features

- 4.2-inch three-color e-ink screen
- 400×300 pixels display with high contrast and ultra-wide viewing angle
- Ultra-low power consumption with long battery life
- Enable quickly modifying the displayed content remotely and locally
- Support multicast feature for deployment and management in bulk
- Provide customized templates and service interface for self-developed options
- Adapt to multiple scenarios with flexible installation methods
- Equipped with NFC for easy configuration
- Compliant with standard LoRaWAN[®] gateways and network servers

2. Hardware Introduction

2.1 Packing List

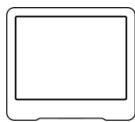

1 ×

DS3604 Device



1 ×

3M Double-Sided Tape



1 ×

Warranty Card



1 ×

Quick Guide



If any of the above items is missing or damaged, please contact your sales representative.

2.2 Hardware Overview

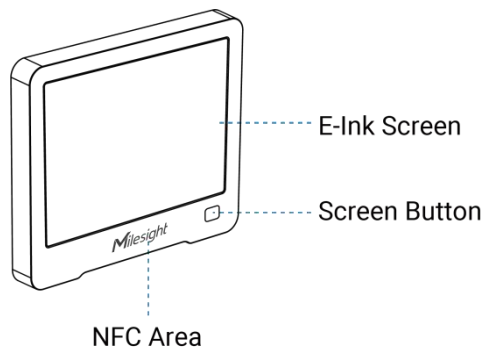

2.3 Dimensions (mm)

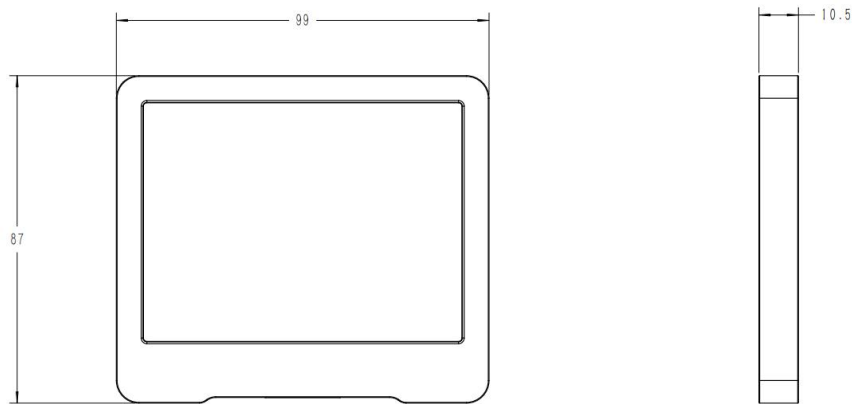

2.4 Power button and Buzzer Patterns

DS3604 equips with power button inside to switch on/off the device for emergency use. Usually, users can use NFC to complete all steps.

Function	Action	Buzz Status
Power On/Off	Press and hold the power button for more than 3 seconds.	Off → Buzz slowly
Reset to Factory Default	Press and hold the power button for more than 10 seconds.	Buzz quickly

3. Operation Guide

3.1 NFC Configuration

DS3604 can be configured via NFC-enabled smartphone.

1. Download and install "Milesight ToolBox" App from Google Play or App Store.

2. Enable NFC on the smartphone and open Milesight ToolBox.
3. Attach the smartphone with NFC area to the device to read device information **when the screen is not refreshing**.

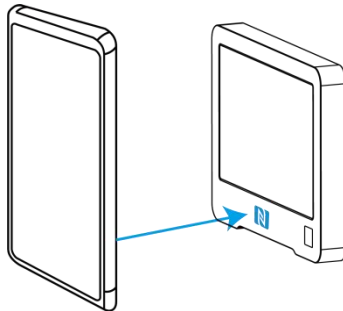

4. Basic information and settings of the device will be shown on ToolBox if it's recognized successfully. You can read and configure the device by tapping the Read/Write button on the App. In order to protect the security of devices, password validation is required when first configuration. The default password is **123456**.

Note:

- 1) When DS3604 is refreshing the screen, do not read or write device or it will show timeout.
- 2) Ensure the position of smartphone NFC area and it's recommended to take off phone case.
- 3) If the smartphone fails to read/write configurations via NFC, move the phone away and back to try again.
- 4) DS3604 can also be configured by ToolBox software via dedicated NFC reader provided by Milesight IoT.

3.2 LoRaWAN Settings

LoRaWAN settings are used for configuring the transmission parameters in LoRaWAN® network.

3.2.1 Basic Settings

Go to **Device > Setting > LoRaWAN Settings** of ToolBox App to configure join type, App EUI, App Key and other information. You can also keep all settings by default.

Device EUI

24E124785C382260

* APP EUI

24e124c0002a0001

* Application Port

- 85 +

Join Type

OTAA

* Application Key

Parameters	Description
Device EUI	Unique ID of the device which can also be found on the label.
App EUI	Default App EUI is 24E124C0002A0001.
Application Port	The port is used for sending and receiving data, the default port is 85.
Join Type	OTAA and ABP modes are available.
Application Key	Appkey for OTAA mode, default is 5572404C696E6B4C6F52613230313823.
Device Address	DevAddr for ABP mode, default is the 5 th to 12 th digits of SN.
Network Session Key	Nwkskey for ABP mode, default is 5572404C696E6B4C6F52613230313823.
Application Session Key	Appskey for ABP mode, default is 5572404C696E6B4C6F52613230313823.
LoRaWAN Version	V1.0.2 and V1.0.3 are available.
Work Mode	Class A and Class B are available. The default mode is Class B.
Ping Slot Periodicity/s	When work mode is Class B, set the interval to open the reception window. Note: this parameter can be increased to extend battery life.
RX2 Data Rate	RX2 data rate to receive downlinks.
RX2 Frequency	RX2 frequency to receive downlinks. Unit: Hz
Channel Mode	Select Standard-Channel mode or Single-Channel mode. When Single-Channel mode is enabled, only one channel can be selected to send uplinks. Please enable Single-Channel mode if you connect device to DS7610.
Channel	Enable or disable the frequency to send uplinks.

* Support Frequency

EU868

868.1

868.3

868.5

863

If frequency is one of CN470/AU915/US915, enter the index of the channel that you want to enable and make them separated by commas.

Examples:

1, 40: Enabling Channel 1 and Channel 40

1-40: Enabling Channel 1 to Channel 40

1-40, 60: Enabling Channel 1 to Channel 40 and Channel 60

All: Enabling all channels

Null: Indicates that all channels are disabled

* Support Frequency

AU915

Enable Channel Index ⓘ

8-15

Index	Frequency/MHz ⓘ
0 - 15	915.2 - 918.2
16 - 31	918.4 - 921.4
32 - 47	921.6 - 924.6
48 - 63	924.8 - 927.8
64 - 71	915.9 - 927.1

Spread Factor	If ADR is disabled, the device will send data via this spread factor.
Confirmed Mode	If the device does not receive ACK packet from network server, it will resend

	data once.
Rejoin Mode	<p>Reporting interval \leq 35 mins: the device will send a specific number of LinkCheckReq MAC packets to the network server with periodic or threshold uplinks everytime more than 25~35 mins passes to validate connectivity; If there is no response, the device will re-join the network.</p> <p>Reporting interval $>$ 35 mins: the device will send a specific number of LinkCheckReq MAC packets to the network server every reporting interval to validate connectivity; If there is no response, the device will re-join the network.</p>
Set the number of packets sent	<p>When rejoin mode is enabled, set the number of LinkCheckReq packets sent.</p> <p>Note: the actual sending number is Set the number of packet sent + 1.</p>
ADR Mode	Allow network server to adjust datarate of the device.
Tx Power	Transmit power of the device.

Note:

- 1) Please contact sales representative for device EUI list if there are many units.
- 2) Please contact sales representative if you need random App keys before purchase.
- 3) Select OTAA mode if you use Milesight IoT Cloud to manage devices.
- 4) Only OTAA mode supports rejoin mode.

3.2.2 Multicast Settings

DS3604 supports setting up several multicast groups to receive multicast commands from the network server. Users can use this feature to update screen contents in bulks. If you do not use this feature, it is suggested to disable this feature to extend battery life.

1. Ensure the work mode is Class B.
2. Enable Multicast Group and set an unique multicast address and keys to distinguish other groups. You can also keep these settings by default.

Multicast Group1

Multicast Address [i](#)

McNetSKey

McAppSKey

Multicast Ping Slot Periodicty/s

Multicast Data Rate

Multicast Frequency

Multicast Group2

Multicast Group3

Multicast Group4

Parameters	Description
Multicast Address	Unique 8-digit address to distinguish different multicast groups.
McNetSkey	32-digit key. Default values: Multicast Group 1: 5572404C696E6B4C6F52613230313823 Multicast Group 2: 5572404C696E6B4C6F52613230313824 Multicast Group 3: 5572404C696E6B4C6F52613230313825 Multicast Group 4: 5572404C696E6B4C6F52613230313826
McAppSkey	32-digit key. Default values: Multicast Group 1: 5572404C696E6B4C6F52613230313823 Multicast Group 2: 5572404C696E6B4C6F52613230313824 Multicast Group 3: 5572404C696E6B4C6F52613230313825 Multicast Group 4: 5572404C696E6B4C6F52613230313826
Multicast Ping Slot Periodicity/s	Set the interval to open the reception window. Note: this parameter can be increased to extend battery life.
Multicast Data	Multicast data rate to receive multicast commands.

Rate	
Multicast Frequency	Multicast frequency to receive multicast commands. Unit: Hz

3. Add a multicast group on the network server. Take Milesight UG6x gateway as example, go to **Network Server > Multicast Groups**, click **Add** to add a multicast group.

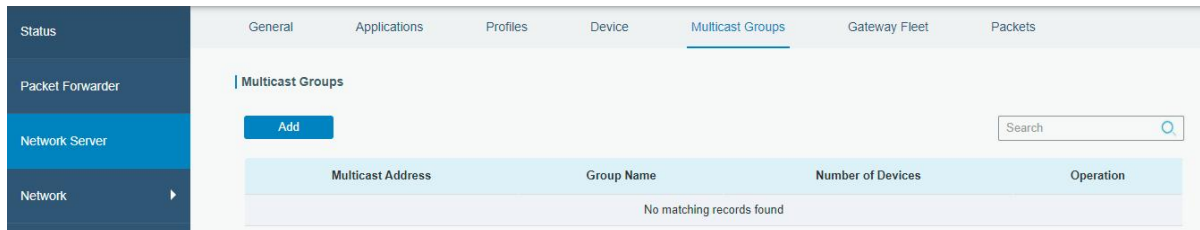

Fill in the multicast group information the same as DS3604 settings, and select the devices which you need to control, then click **Save**.

Group Name	Screen Update
Multicast Address	11111111
Multicast Network Session Key	5572404C696E6B4C6F526132
Multicast Application Session Key	5572404C696E6B4C6F526132
Class Type	Class B
Datarate	DR2 (SF10, 125 kHz)
Frequency	508300000 Hz
Frame-counter	0
Ping Slot Periodicity	Every 16 second
Selected Devices	
Screen1 x 24E124126B511334 x	

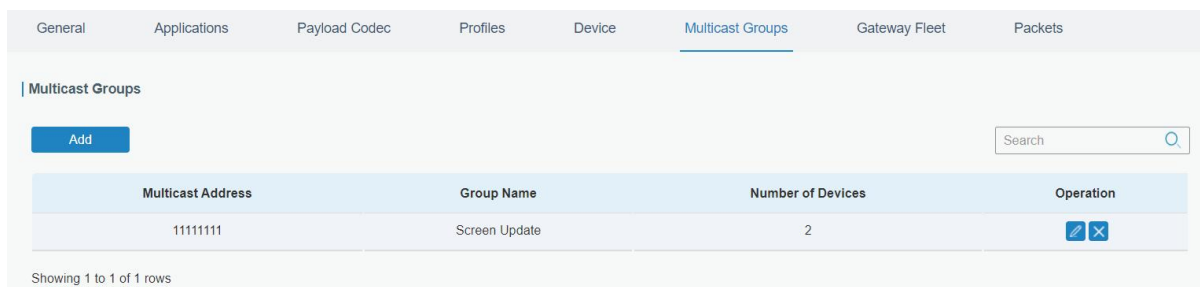

4. Go to **Network Server > Packets**, select the multicast group and fill in the downlink command, click **Send**. The network server will broadcast the command to devices that belong to this

multicast group.

Note: ensure all devices' application ports are the same.

The screenshot shows the 'Send Data to Multicast Group' section of the Milesight web interface. The section is highlighted with a red border. It includes the following fields and controls:

- Send Data To Device:** A section with a table-like structure containing fields for Device EUI (0000000000000000), Type (ASCII), Payload, Port (85), and a Confirmed checkbox. A 'Send' button is present.
- Send Data to Multicast Group:** A section highlighted with a red border, containing fields for Multicast Group (Screen Update), Type (hex), Payload (fb01000474657374ff3d02), and Port (85). A 'Send' button is present.

3.3 General Settings

Go to **Device > Setting > General Settings** of ToolBox App to change the reporting interval, etc.

The screenshot shows the 'General Settings' section of the ToolBox App. The settings are as follows:

- Reporting Interval:** 1080 min (with minus and plus buttons)
- Buzzer:** Disabled (toggle switch)
- Button:** Disabled (toggle switch)
- Display Template:** Template 2 (dropdown menu)
- Least Refresh Interval:** 30 Day (with minus and plus buttons)
- Change Password:** Disabled (toggle switch)

Parameters	Description
Reporting Interval	The interval of sending battery level and display template option to network server. Range: 1-1080 mins, default: 1080 min
Buzzer	When buzzer is enabled, it will response when you press the button or the device receives the downlink command to refresh the screen.
Button	If device does not join the network, press this button to send a join request packet; if device has joined the network, the device will uplink a packet. It is suggested to enable this button if work mode is Class A.
Display Template	Select the display template. DS3604 supports 2 templates at most.
Least Refresh Interval	The interval to full refresh the screen. Range: 1-90 days, default: 30 days.
Change Password	Change the password for ToolBox App or ToolBox software to write this device.



3.4 Display Settings

DS3604 provides 2 display templates and supports display content programming according to user requirements. Besides, users can use default template 1 on dynamic hot desk reservation and default template 2 on fixed workplace display signage applications.

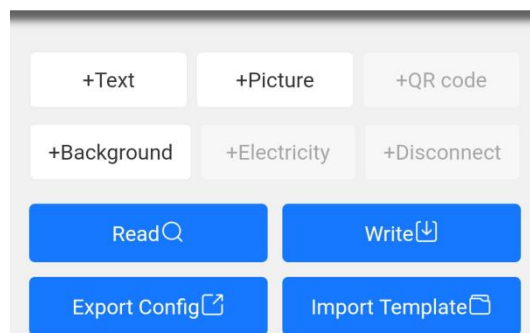
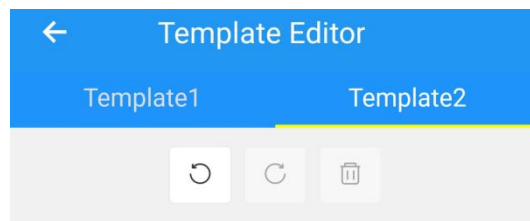
1. Go to **Device > Setting > Display Settings** of ToolBox App to add module directly or click **Read** and attach the smartphone with NFC area to the device to get the default display template.



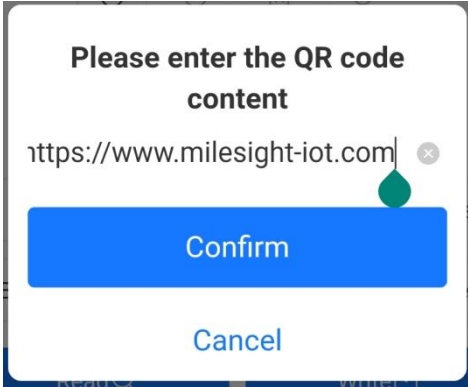



Icon	Description
Text	Double click to edit the text content or single click to adjust the properties (color, background, size, font-family, font-weight, align) or drag to move this module. One template can add 10 text modules at most and every text can include 63 characters at most.
Image	Double click to import an image or single click to adjust the properties or drag to move this module. One template can only add one image and the resolution must be 400*300.
QR Code	Edit the website URL or a series of strings to generate a QR code. One template can only add one QR code.

	
<p>Background</p>	<p>Import an image as background, the image resolution should be 400*300. Two templates can only add one background.</p>
<p>Electricity</p> 	<p>When battery level is lower than 10%, this module will display. The properties of this module are non-editable and you can change the location by dragging it or modify the X&Y value.</p>
<p>Disconnect</p> 	<p>When the device fails to join the network, this module will display. The properties of this module is non-editable and you can change the location by dragging it or modify the X&Y value. Note: after the device joining the network, the screen will refresh to remove this module.</p>

2. Click any module to enter the edit mode and change the properties of module. After complete, click blank area out of the template to exit the edit mode.



Icon	Description
	Returns to last edit.
	Go to next edit.
	Delete this module.
	Click the module ID to adjust the layer order of this module.

3. Click **Write** to save this template and write it to the screen.
4. Click **Export Config** to save current template to your smartphone and you can import this template to another device by clicking **Import Template**.

3.5 Maintenance

3.5.1 Upgrade

1. Download firmware from Milesight website to your smartphone.
2. Open ToolBox App and click **Browse** to import firmware and upgrade the device.

Note:

- 1) Operation on ToolBox is not supported during the upgrade.
- 2) Only Android version ToolBox supports the upgrade feature.

Status	Setting	Maintenance
SN	6601C42255890001	
Model	DS3604-470M	
Firmware Version	V1.1-a3	
Hardware Version	V1.0	
Manual Upgrade		
Browse		

3.5.2 Backup

DS3604 supports configuration backup for easy and quick device configuration in bulk. Backup is allowed only for devices with the same model and LoRaWAN® frequency band.

1. Go to **Template** page on the App and save current settings as a template. You can also edit the template file. Note that this template only includes device basic parameter settings.
2. Select one template file that saved in the smartphone and click **Write**, then attach it to another device to write configuration.

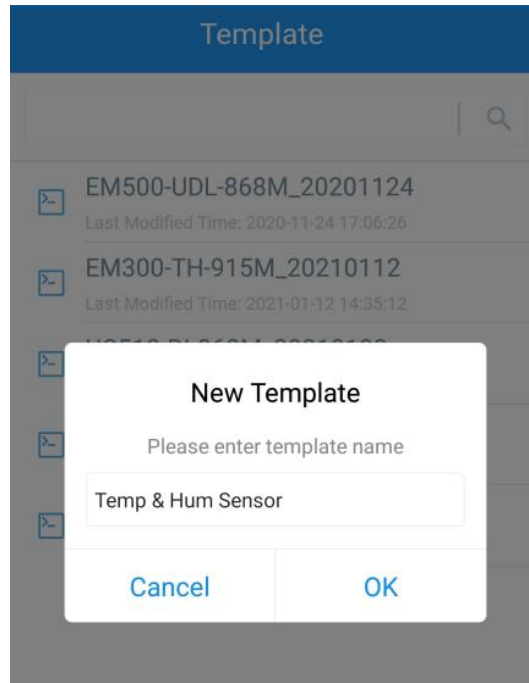

Note: Slide the template item to the left to edit or delete the template. Click the template to edit the configurations.

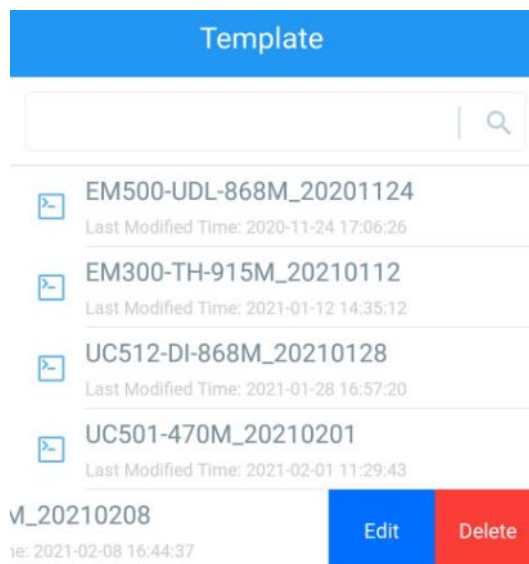

3.5.3 Reboot and Reset

Via Hardware: Hold on the power button inside the device for 3s to reboot, 10s to reset.

Via Toolbox App: Go to **Device > Maintenance** to tap **Reset**, then attach smartphone with NFC area to the device to complete reboot or reset.

Status	Setting	Maintenance
SN	6601C42255890001	
Model	DS3604-470M	
Firmware Version	V1.1-a3	
Hardware Version	V1.0	
Manual Upgrade		
Browse		
Restore Factory Default		
Reset		

4. Installation

DS3604 can be placed on the desktop directly. If it needs to be fixed, please try below installation methods.

Fixed by 3M Tapes:

Paste 3M tape to the back of the device, then tear the other side and place it on a flat surface. Please note the screen direction when installing.

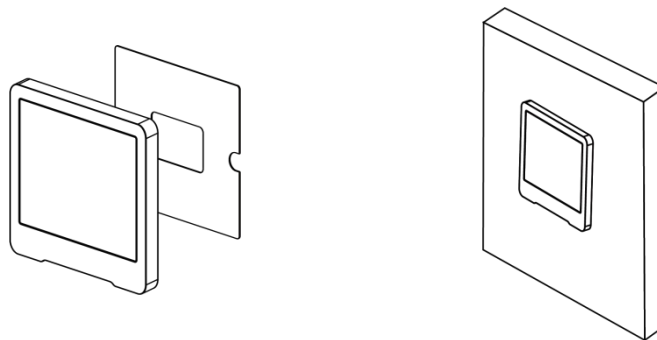

Fixed by Screws:

1. Release the screw on the bottom of device and remove the back cover, mark the installing holes to the wall according to the holes on the back cover.
2. Fix the back cover with two M3 screws and install back the device, then fix the bottom of device to back cover with the fixing screw.

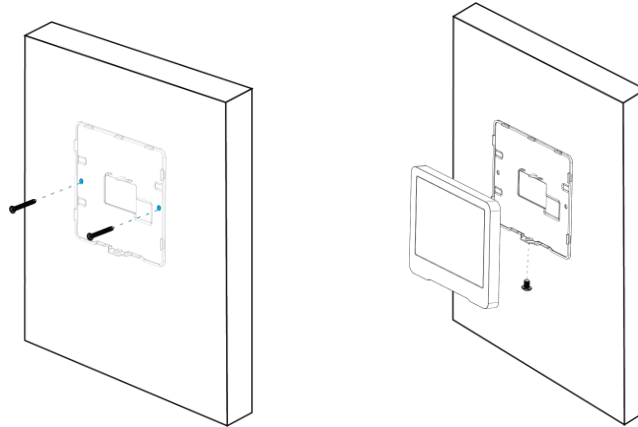

Installation Note:

If the installation location is a metal surface or includes metal materials, please leave the upper part of device 3 to 4 cm away from the surface to avoid the signal problem.

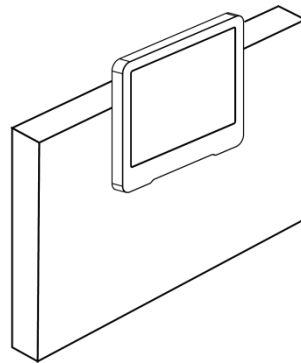

5. Device Payload

All data are based on the following format(HEX), the Data field should follow little -endian:

Channel1	Type1	Data1	Channel2	Type2	Data2	Channel 3	...
1 Byte	1 Byte	N Bytes	1 Byte	1 Byte	M Bytes	1 Byte	...

For decoder examples you can find them at <https://github.com/Milesight-IoT/SensorDecoders>.

5.1 Basic Information

DS3604 report basic information of panel whenever joining the network.

Channel	Type	Description
ff	01(Protocol Version)	01=> V1
	09 (Hardware Version)	01 40 => V1.4
	0a (Software Version)	01 14 => V1.14
	0b (Power On)	Device is on
	0f (Device Type)	00: Class A, 01: Class B, 02: Class C
	16 (Device SN)	16 digits

Example:

ff0bff ff0101 ff166601c42255890001 ff090100 ff0a0101 ff0f01					
Channel	Type	Value	Channel	Type	Value
ff	0b (Power On)	ff (Reserved)	ff	01 (Protocol Version)	01 (V1)
Channel	Type	Value	Channel	Type	Value
ff	16(Device SN)	6601c422558 90001	ff	09 (Hardware version)	0100 (V1.0)
Channel	Type	Value	Channel	Type	Value
ff	0a (Software version)	0101 (V1.1)	ff	0f (Device Type)	01(Class B)

5.2 Screen Data

DS3604 reports below data according to reporting interval (1080 mins by default) and when template mode switches or template content changes.

Channel	Type	Description
01	75(Battery Level)	UINT8, Unit: %
ff	73(Display Template)	00: template 1 01: template 2
ff	2e (Button Uplink)	00

Example:

1. Periodic package

01755f ff7301					
Channel	Type	Value	Channel	Type	Value
01	75 (Battery)	64 => 100%	ff	73 (Display template)	01: template 2

2. Press the button to send a uplink

ff2e00 ff7301					
Channel	Type	Value	Channel	Type	Value
01	2e (Button Uplink)	00	ff	73 (Display template)	01: template 2

Note: the device will report low battery alarm packet if it detects the battery level is lower than 10%.

5.3 Control Commands

DS3604 supports downlink control commands to configure the device. Application port is 85 by default.

Channel	Type	Description
ff	03 (Set Reporting Interval)	2 Bytes, unit: s
	10 (Reboot)	ff (Reserved)
	25 (Button)	00: Disable 01: Enable
	3d (Action)	01: Buzz twice 02: Screen refresh once
	3e (Buzzer)	00: Disable 01: Enable
	73 (Display Template)	00: template 1 01: template 2
	82 (Multicast group)	1 Byte, Bit 4~7: multicast group 1 to 4 change status, 0 = not allow control, 1 = allow control. Bit 0~3: multicast group 1 to 4 control status, 0 for disable, 1 for enable. Note: after disabling or enabling, the device will re-join the network.
	90 (Button template switch)	00: Disable to press button to switch template 01: Enable to press button to switch template Note: if enabled, the button uplink content will add battery level.

Example:

1. Set reporting interval as 20 minutes.

ff03b004		
Channel	Type	Value
ff	03 (Set Reporting Interval)	b0 04=>04 b0=1200s =20 minutes

2. Reboot the device.

ff10ff		
Channel	Type	Value
ff	10 (Reboot)	ff (Reserved)

3. Set multicast group 1 as disable.

ff8210		
Channel	Type	Value
ff	82 (Multicast group)	10=>0001 0000 Bit4=1=>group1, bit 0=0=>disable

5.4 Screen Content Update

DS3604 supports downlink commands to update screen contents. After sending content update command, it is necessary to send command ff3d02 to refresh the screen.

Command format:

Channel	Type	Description
fb	01 (Text/QR Code Content Update)	ID (1B)+Content Size(1B)+Content (Mutable) ID: Bit 7-bit 6: 00=template 1, 01=template 2 Bit5-Bit 0: module ID Content: UTF-8 format content

Reply format:

Channel	Type	Description
fa	01 (Text/QR Code Content Update)	ID(1B)+Code(1B) ID: Bit 7-bit 6: 00=template 1, 01=template 2 Bit5-Bit 0: module ID Code description: 00: content update success 01: no this template 02: no this module 03: invalid content length 04: this module is non-editable

Note:

- 1) Please export the json format template file after adjustment via ToolBox App, every module information will be saved in order on template file and users can calculate the module ID according to the file order.
- 2) For more screen update settings, please use with Yeastar Workplace platform or Milesight gateways which support DS3604 screen update API.

Example:

1. Set title as test and fresh the screen to check the result.

fb01000474657374ff3d02					
Channel	Type	Value	Channel	Type	Value
fb	01 (Text content update)	00: template 1, module 1 04: content size is 4 bytes 74657374: test	ff	3d(Screen Refresh)	02

Reply:

fa010000 fe3d02					
Channel	Type	Value	Channel	Type	Value
fa	01 (Text content update)	00: template 1, module 1 00: update success	fe	3d(Screen Refresh)	02

-END-