



X1 Sensing Camera

SC541

User Guide



Safety Precautions

Milesight will not shoulder responsibility for any loss or damage resulting from not following the instructions of this operating guide.

- ❖ The device must not be disassembled or remodeled in any way.
- ❖ To avoid risk of fire and electric shock, do keep the product away from rain and moisture before installation.
- ❖ Do not place the device where the temperature is below/above the operating range.
- ❖ The device must never be subjected to shocks or impacts.
- ❖ Make sure the device is firmly fixed when installing.
- ❖ The battery should be removed from the device if it is not to be used for an extended period. Otherwise, the battery might leak and damage the device. Never leave a discharged battery in the battery compartment.
- ❖ Make sure all batteries are newest when install, or battery life will be reduced.
- ❖ Do not expose the device to where a laser beam equipment is used.

Declaration of Conformity

SC541 is in conformity with the essential requirements and other relevant provisions of the CE, FCC, and RoHS.



Copyright © 2011-2023 Milesight. All rights reserved.

All information in this guide is protected by copyright law. Whereby, no organization or individual shall copy or reproduce the whole or part of this user guide by any means without written authorization from Xiamen Milesight IoT Co., Ltd.

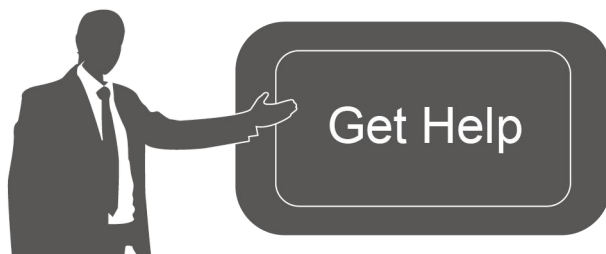

For assistance, please contact

Milesight technical support:

Email: iot.support@milesight.com

Support Portal: support.milesight-iot.com

Tel: 86-592-5085280

Fax: 86-592-5023065

Address: Building C09, Software Park
Phase III, Xiamen 361024,
China

Revision History

Date	Doc Version	Description
March 15, 2023	V 1.0	Initial version

Contents

1. Product Introduction	5
1.1 Overview	5
1.2 Key Features	5
2. Hardware Introduction	5
2.1 Packing List	5
2.2 Hardware Overview	6
2.3 Button and LED Patterns	6
2.4 Dimensions (mm)	6
3. Power Supply	7
4. Installation	7
5. Access the Camera	8
6. Operation Guide	8
7. Communication Protocol	12

1. Product Introduction

1.1 Overview

X1 Sensing Camera SC541 is a creative AIoT product with applicable and intelligent applications. By capturing pictures, SC541 can replace human inspection in multiple scenarios and economize manpower. High-quality picture-capturing function and embedded supplement light make it more competitive and useful under different environmental conditions.

SC541 has featured low-power consumption and allows for different power supplying methods for extending its service life and maximizing its utilization.

With a compact size, SC541 allows for easy deployment. It supports easy configuration via Wi-Fi and allows for remote management and data transmission via standard MQTT to the Milesight AIoT Sensing Platform.

1.2 Key Features

- Provide full HD resolution 1920 x 1080 pixels
- Support multi-type picture-capturing modes depending on time interval, scheduled time, Alarm-in settings, and one external button.
- Equip with one advanced supplement light to increase light level under specific conditions
- Compact size with wireless deployment
- Smart sleep-mode logic and low-power consumption provide it a longer service life
- Provide universal camera bracket interface for more installation options
- Support easy configuration via wireless Wi-Fi connection
- Support remote management with assorted Milesight AIoT Sensing Platform for extended applications

2. Hardware Introduction

2.1 Packing List



1 × SC541 Device

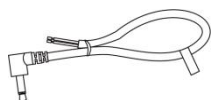

1 × Alarm

Transfer Cable



1 × Quick Start Guide



1 × Warranty

Card



If any of the above items is missing or damaged, please contact your sales representative.

2.2 Hardware Overview

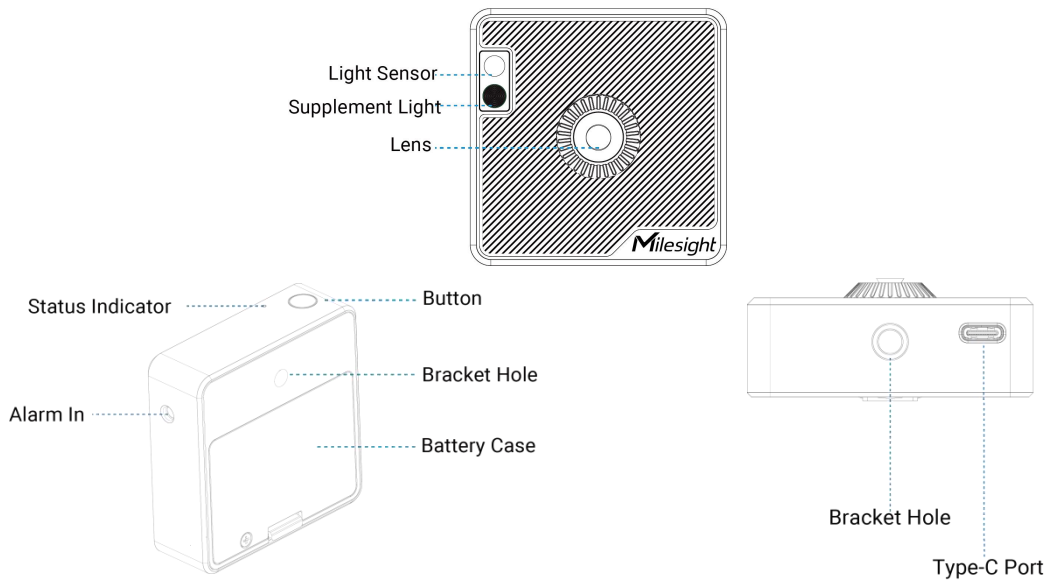

2.3 Button and LED Patterns

Function	Action	LED Indication
Device Weak-up	Press the button once.	Off → Static On
Capture One Picture	After device wakes up, capture the picture by pressing the button once or triggering via alarm input/software.	Blinks twice
Enter Sleep Mode	When the device is not being connected for 1 minute or there's no operation on the device for 5 minutes after being connected.	On → Off
Reset to Factory Default	Press and hold the button for more than 3 seconds.	Blinks constantly

2.4 Dimensions (mm)

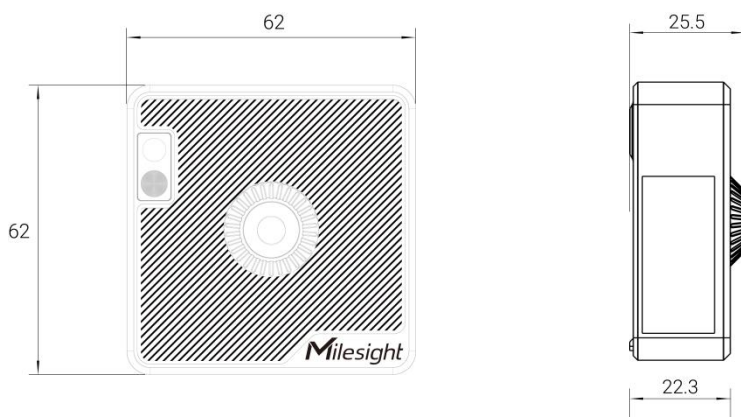

3. Power Supply

1. Unscrew the battery case and remove the battery cover, insert the two new AA/LR6 alkaline batteries into the battery case of device with correct direction. After inserting, the device will be powered on automatically.

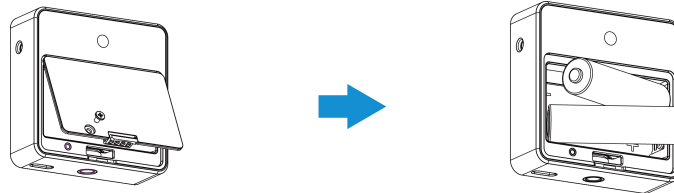

2. Put the battery cover back and fix it with the screw.

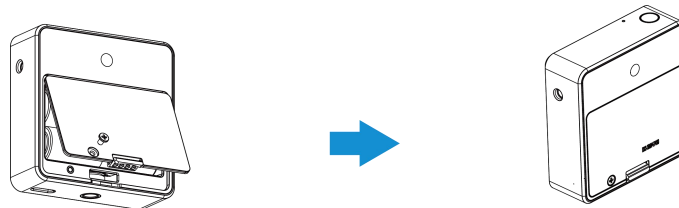

Note:

- SC541 can also be powered via USB type-C port(5V/1A). When batteries and external power are both used, external power will be the preferred power supply option.
- SC541 only supports alkaline batteries, not Li-SOCl₂ batteries.
- Type-C port can't be used to charge batteries.

4. Installation

SC541 can be fixed to most kind of general camera brackets through different bracket holes.

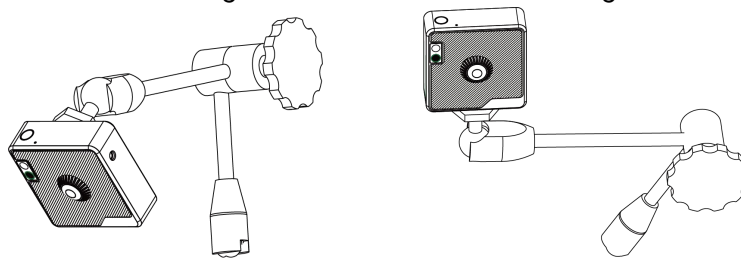

Installation Note:

- To avoid reflections from the object surface like meter, make sure the device and the target object forming a certain angle instead of being installed in front of it.
- The best distance between the device and the target object to be captured is 10 to 20cm. You can also log in to the webpage to view the live image stream for adjustment.

5. Access the Camera

SC541 provides user-friendly web GUI for configuration and users can access it via Wi-Fi connection. The recommended browsers are Chrome, Microsoft Edge, and Safari. The default IP of camera is 192.168.1.1, and default SSID is **SC541_XXXXXX** (can be found on the label).

Step 1: Install the batteries to power on the device, press the button on the device to wake it up. The LED indicator will turn on when the device wakes up.

Step 2: Enable the Wireless Network Connection on your computer or smartphone and search for corresponding access point of the device, then connect to this access point.

Step 3: Open a Browser and type **http://192.168.1.1** to access the web GUI.

Note:

1. When the device is not being connected for 1 minute or there's no operation on the device for 5 minutes after being connected, the device will enter sleep mode automatically and you can not find the Wi-Fi access point.
2. The display will not smooth since it updates the live view as images not videos.
3. If multiple devices need to be configured, it is suggested to clean the caches of browser before every device configuration or use incognito mode of browsers to ensure the configurations are all taken effect.

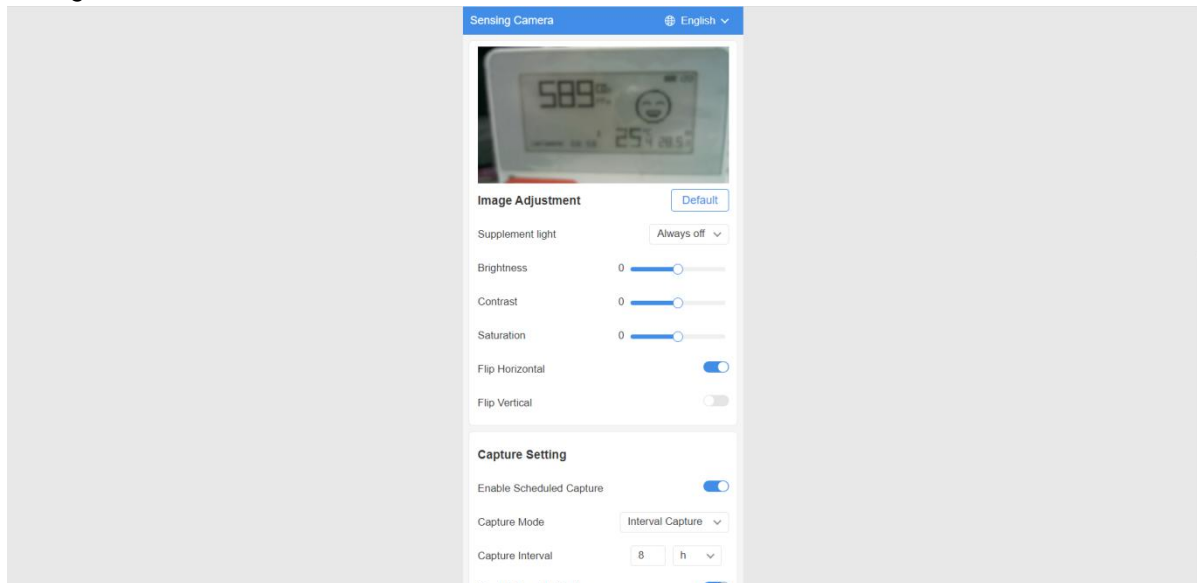

6. Operation Guide

Step 1: Adjust the distance and image settings to ensure a clear view to read the meter values.

Image Adjustment Default

Supplement light Customize ▾

Time Range 23 : 00 - 07 : 00

Brightness 0

Contrast 0

Saturation 0

Flip Horizontal

Flip Vertical

Image Adjustment	
Parameters	Description
Supplement Light	Set supplement light mode. Auto: when environment light value is lower than light threshold, turn on the light Customize: set the time range to turn on the light Always on: turn on the light continuously Always off: turn off the light continuously
Brightness	Adjust the brightness of the live image stream.
Contract	Adjust the color and light contrast.
Saturation	Adjust the Saturation of the image. Higher Saturation makes colors appear more "pure" while lower one appears more "wash-out".
Flip Horizontal	Horizontal flip the live image stream.
Flip Vertical	Vertical flip the live image stream.
Default	Restore to default image adjustment settings.

Step 2: Set the condition to capture.

Capture Setting

Enable Scheduled Capture

Capture Mode Timed Capture ▾

Time Setting Daily ▾ 00 : 00 +

Mon. 00:00 X Wed. 10:00 X

Sun. 11:00 X Daily 00:00 X

Enable Alarm-In Capture

Enable Capture Button

Capture Setting

Parameters	Description
Enable Scheduled Capture	Enable or disable to capture by schedule. Timed Capture: set the weekday and time to capture Interval Capture: set the interval (min, hour, day) to capture
Enable Alarm-in Capture	Enable or disable to capture the picture when it receives a high level signal for 150us from alarm-in interface. The voltage range of alarm in: High Level: 3-5V Low Level: <0.5V
Enable Capture Button	Enable to press the button to capture the picture when the device has been woke up.

Step 3: Set MQTT broker information. When the device captures a picture, it will send the picture to MQTT broker immediately.

Note:

- 1) If the device drops connection, it can store up to 40 pictures locally. When connection restores back, the device will send stored pictures right away.
- 2) Keep topic, username and password settings as default if you need to connect device to Milesight AIoT Sensing platform.

MQTT Settings

Enable

Host

Port

Topic

Username

Password

[Save](#)

MQTT Setting	
Parameters	Description
Enable	Enable or disable to send pictures to MQTT broker.
Host	The address of MQTT broker.
Port	The communication port of MQTT broker.
Topic	Topic name of the data type used for publishing.
Username	The username to connect to MQTT broker.
Password	The password to connect to MQTT broker.

Step 4: Check basic information of device and upgrade if necessary.

Device Maintenance

Device Name

MAC Address 34:85:18:44:57:90

SN 29902309N3L2

Battery 100%

Hardware Version V1.0

Firmware Version C_54.1.0.1

Upgrade Firmware

[Browse](#) [Upgrade](#)

Parameters	Description
------------	-------------

Device Name	Customize a device name.
MAC Address	MAC address of Wi-Fi interface.
SN	A unique serial number of device.
Battery	Battery level of the device.
Hardware Version	Hardware version of device. It's fixed.
Firmware Version	Firmware version of device. It can be upgraded.
Upgrade Firmware	Click the Browse button and select the upgrading file locally, then click the Upgrade button to upgrade. After the system reboots successfully, the update is done. Note: Do not disconnect the power of the device during the upgrade process. The device will be restarted to complete the upgrading.

Step 5: click **Refresh** to scan the Wi-Fi access point of network router and connect to it. If all settings are completed, click **Sleep Mode**.

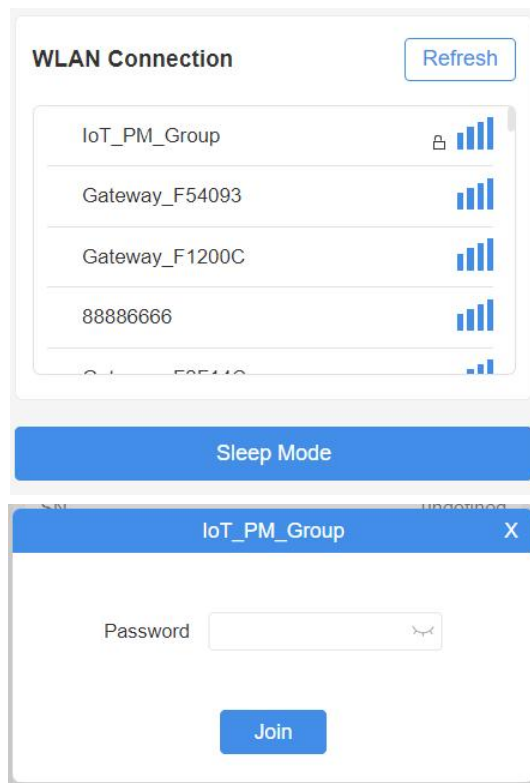

7. Communication Protocol

SC541 will send device information and screenshot data in json format to MQTT broker. The red part is the screenshot content displayed as base64 format.

```
{
  "ts": 1689065610613, //capture timestamp, unit: ms
```

```
"values":  
{  
  "devName": "X1 Sensing Camera",  
  "devMac": "1C:C3:16:43:01:62",  
  "battery": 82,  
  "snapType": "Button", //capture type: Button, Timer, Alarm in  
  "localtime": "2023-07-11 16:53:30", //upload time  
  "imageSize": 62163,  
  "image": "data:image/jpeg;base64,/9j/4AAQSkZJRgABAQA...(Image code)"  
}  
}
```

-END-