

PyroMini Series

Operator's Guide



INTERNATIONAL OPERATOR'S GUIDE (DE / EN / ES / FR / IT)

Can be downloaded here: www.calex.co.uk/pyromini

INTRODUCTION

The PyroMini Series is a range of miniature non-contact infrared temperaturesensors with separate electronics modules.

All models have an adjustable emissivity setting and are capable of measuring a wide variety of target materials, including food, paper, textiles, plastics, leather, tobacco, pharmaceuticals, chemicals, rubber, coal and asphalt.

General-purpose PyroMini models measure non-reflective non-metals, or painted or coated metals, at temperatures from -20°C to 1000°C.

PyroMini 2.2 models have a short measurement wavelength. They are ideal for measuring reflective surfaces such as uncoated iron and steel, as well as many other high-temperature applications. They are capable of measuring temperatures from 100°C to 2000°C.

The optional touch screen interface provides temperature indication, alarms, sensor configuration and data logging to MicroSD Card. The optional high-temperature sensing head on general-purpose models may be used in ambient temperatures of up to 180°C without cooling. The low-noise cable on high ambient temperature models is resistant to interference from movement, so it is ideal for mounting on moving objects such as robot arms.

A choice of optics is available to measure small or large targets at short or long distances, and there is a choice of 4-20 mA, RS485 Modbus and alarm relay outputs.

SPECIFICATIONS

GENERAL		
	PyroMini	PyroMini 2.2
Temperature Range	See table of Model Numbers	
Maximum Temperature Span (-CRT models)	Full temperature range (up to 1550°C)	
Minimum Temperature Span (-CRT models)	100°C	
Output	4 to 20 mA or RS485 Modbus	
Field of View	See table of Model Numbers	
Accuracy	± 1°C or 1% of reading, whichever is greater	± 2°C or 1% of reading, whichever is greater
Repeatability	± 0.5°C or 0.5% of reading, whichever is greater	
Emissivity Setting Range	0.20 to 1.00	0.10 to 1.00
Emissivity Setting Method	<ul style="list-style-type: none">• -CB models: via two rotary switches in electronics module• -BB and -BT models: via RS485• -CRT and -BT models: via touchscreen	
Response Time, t_{90}	240 ms (90% response)	
Spectral Range	8 to 14 μm	2.0 to 2.6 μm
Supply Voltage	24 V DC \pm 5%	
Maximum Current Draw	2 x100 mA	
Alarm Relays (-CRT models)	2 x Single Pole Changeover alarm relays rated 24 V DC, 1 A, isolated 500 V DC	
Maximum Loop Impedance	-CB and -CRT models: 900 Ω (4 to 20 mA output)	

MECHANICAL			
	Sensing head	Electronics Module	
Construction	Stainless Steel 316	Die-cast Aluminium	
Major Dimensions	∅18 x 45 mm	98(w) x 64(h) x 36(d) mm	
Mounting	M16 x 1 mm thread	Two M4 screws for wall mounting (see diagram)	
Cable Length (sensing head to electronics module)	1 m (standard), up to 30 m (optional)		
Weight with 1 m Cable	390 g (approx)		
Cable Connections	Removable screw terminal blocks (see Connections). Conductor size: 28 AWG to 18 AWG		
Output Cable Gland	Suitable for cable diameters 3.0 to 6.5 mm		
ENVIRONMENTAL			
	Sensing Head	Electronics Module (without touch screen)	Electronics Module (with touch screen)
Environmental Rating	IP65 (NEMA 4)	IP65 (NEMA 4)	-
Ambient Temperature Range	See table of Model Numbers	0°C to 60°C	0°C to 60°C
Relative Humidity	Maximum 95% non-condensing	Maximum 95% non-condensing	Maximum 95% non-condensing
CE Marked	Yes	Yes	Yes
RoHS Compliant	Yes	Yes	Yes

The PyroMini series conforms to EMC Directive EN61326-1:2006 (Electrical equipment for measurement, control and laboratory use – Industrial) as well as industrial standards for electromagnetic immunity and emissions.

MODEL NUMBERS

The following combinations of ambient temperature range, optics, measured temperature range, output and interface are available:

Series	Sensing Head Operating Temperature Range	Field of View	Temperature Range	Output and Interface
PM General Purpose (8-14 µm)	MA (0-60°C)	21 (2:1) 151 (15:1) 301 (30:1) CF (close focus)	LT (-20 - 100°C) MT (0 - 250°C) HT (0 - 500°C) XT (0 - 1000°C)	CB
			CT (-20 - 1000°C)	CRT BB BRT
	HA (0-180°C) JA (0-120°C)	201 (20:1) HCF (close focus)	LT (-20 - 100°C) MT (0 - 250°C) HT (0 - 500°C) XT (0 - 1000°C)	CB
			CT (-20 - 1000°C)	CRT BB BRT
PM 2.2 High Temperature (2.2 µm)	(all models 0-70°C)	151 (15:1)	PT (100 - 400°C)	CB CRT BB BRT
		251 (25:1) 751 (75:1) CF (close focus)	MT (250 - 1000°C) HT (450 - 2000°C)	

EXTENDED SENSING HEAD CABLE

The sensor is supplied with a 1-metre sensing head cable as standard. It can be ordered with up to 30 metres of sensing head cable.

The sensing head cable length must not be modified by the user, as this may affect the measurement accuracy.

If extended cable is ordered, the total length (in metres) is shown in the model number, for example:

PM-MA-151-CT-CRT-3M (includes a 3-metre sensing head cable)

SENSING HEAD OPERATING TEMPERATURE RANGE

-JA and **-HA** models withstand high ambient temperatures without cooling.

There is no need to supply cooling air or water, and the miniature sensing head is much smaller than bulky, cooled sensors.

FIELD OF VIEW

Diameter of target spot measured versus distance from sensing head at 90% energy. Sensors may be used at longer distances than these diagrams show. There is no maximum measurement distance in clean air.

PyroMini - General Purpose (PM-MA models)

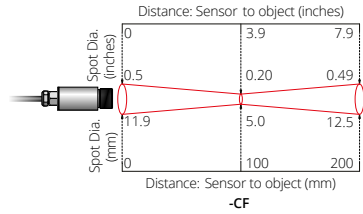
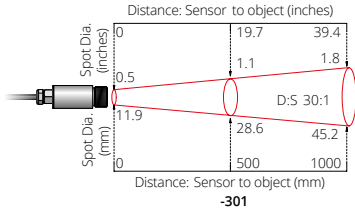
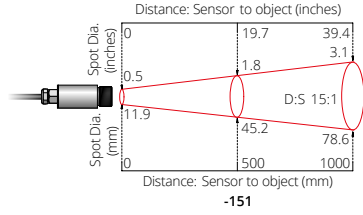
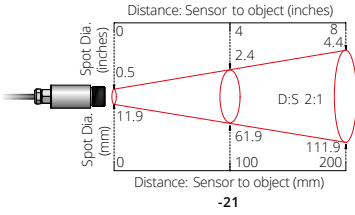

PyroMini - General Purpose (PM-HA and PM-JA models)

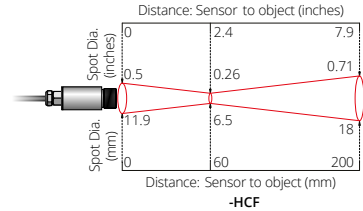
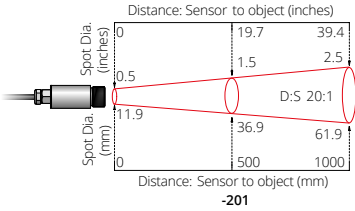

PyroMini 2.2 - High Temperature (PM2.2 models)

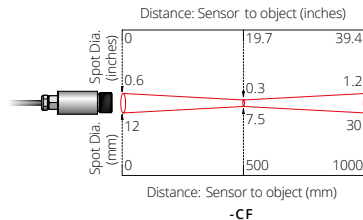
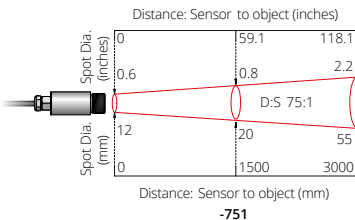
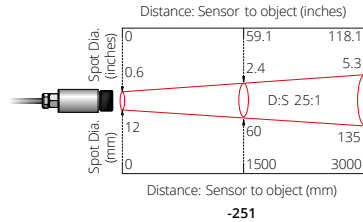
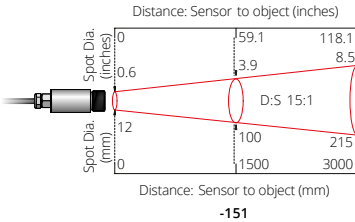

MEASUREMENT TEMPERATURE RANGE

(PyroMini - General Purpose)

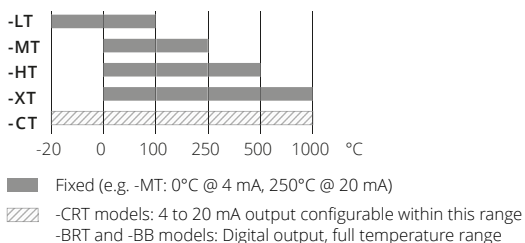

(PyroMini 2.2 - High Temperature)

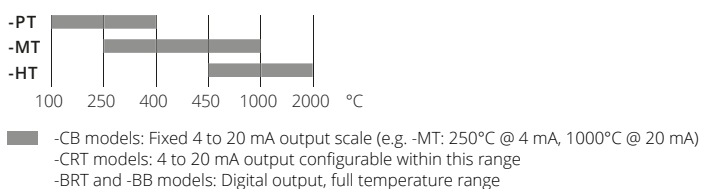

OUTPUT AND INTERFACE

- CB 4 to 20 mA output, without display
- CRT 4 to 20 mA output and two alarm relay outputs, with touch screen
- BB RS485 Modbus output, without display
- BRT RS485 Modbus output and two alarm relay outputs, with touch screen

EXAMPLE: PM-MA-301-CT-BRT

Series	Sensing Head Operating Temperature	Optics	Temperature Range	Output and Interface
PM PyroMini	-MA 0°C to 60°C	-301 30:1 divergent optics	-CT Configurable within the limits: -20°C to 1000 °C	-BRT RS485 Modbus output and two alarm relay outputs, with touch screen

EXAMPLE: PM2.2-251-MT-BRT

Series	Sensing Head Operating Temperature	Measurement Temperature Range Optics	Output and Interface
PM2.2 PyroMini 2.2	251 25:1 divergent optics	MT 250°C to 1000°C	-BRT RS485 Modbus output and two alarm relay outputs, with touch screen

EMISSIONITY ADJUSTMENT (-CB MODELS)

The emissivity setting on -CB models may be adjusted via two rotary switches inside the electronics box.



To adjust the emissivity setting:

Set the left switch to the first digit after the decimal point (0.1).

Set the right switch to the second digit after the decimal point (0.01).

To enter an emissivity setting of 1.00, set both switches to 0.

If the selected emissivity setting is lower than the minimum, the sensor will default to an emissivity setting of 0.95.

For example:

Left switch	Right switch	Emissivity setting
6	3	0.63
0	0	1.00

TOUCH SCREEN (-CRT AND -BRT MODELS)

The optional backlit touch screen interface mounted in the lid of the electronics module provides a large, bright display of the measured temperature, as well as options for full configuration of the sensor. The graph view shows the history of the measured temperature.

In alarm conditions, the display changes colour to provide an immediate and obvious alarm indication. Alarm modes and levels can be configured via the touch screen.

TOUCH SCREEN SPECIFICATIONS

Touch Screen Display Format	2.83" (72 mm) resistive touch TFT, 320 x 240 pixels, backlit
Configurable Parameters	Temperature range, temperature units, emissivity setting, reflected energy compensation, alarms, signal processing, Modbus address (-BRT models), date and time, data logging
Temperature Units	°C or °F configurable
Temperature Resolution	0.1°
Alarm Configuration	Two alarms with adjustable level, individually configurable as HI or LO. Alarm 2 can be set to target temperature or sensing head internal temperature
Signal Processing	Average, peak hold, valley hold, minimum, maximum

User Interface

Default View

Temperature View



Displays a large indication of the measured temperature. The background turns bright red when an alarm is activated.

Setting Temperature

Tap “°C” to switch to °F and vice versa. The units are changed throughout the interface.

MicroSD Card status



This icon is displayed when a MicroSD card is inserted, and flashes when data logging is in progress.



This icon is displayed when scheduled data logging is enabled and has not yet begun.

List View

Displays a list of the measured temperatures.

Filtered Temp:	The measured temperature, with averaging and hold processing.
Unfiltered Temp:	The unprocessed measured temperature.
Average Temp:	The Unfiltered Temperature averaged over the period specified in “Output Processing”.
Maximum Temp:	The highest temperature measured during the hold period, with averaging.
Minimum Temp:	The lowest temperature measured during the hold period, with averaging.
Sensor Temp:	The internal temperature of the sensing head.
Reflected Temp:	The reflected energy compensation temperature, as specified in “Emissivity and Compensation”.

Lock/Unlock



Prevents settings being changed via a four-digit numerical code.
The default password is 1234.



Change Password

Enter, confirm and save a new four-digit code.

Start/Stop Logging



Manually begins or ends data logging (requires MicroSD Card, available separately).

If Scheduled Start is enabled in Settings > Data Logging, then logging cannot be started manually.



To manually start logging, you must first disable Scheduled Start.

Graph



Displays the recent history of the Filtered Temperature and the Sensor Temperature. To scroll backwards and forwards in time, touch the graph and drag it. The graph stores the most recent 24 hours of temperature data.



Reset Graph

Clears and restarts the graph.



Real-Time Scrolling View

Returns the graph to the real-time scrolling view, showing the most recent measurements.

Acknowledge Alarms



Switches the relay outputs for triggered alarms to their normal, untriggered state. The background of the Temperature View, List View and Graph View will stay red, and the alarms will not be triggered again, until the alarms are reset (see "Alarms" below). Alarms can be acknowledged when the display is locked.

Settings



Access the configuration parameters. Tap **Apply** to save the settings, or **Exit** to leave the screen without saving.

If the **Settings** icon is grey, the interface is locked. See "**Lock/Unlock**".



Apply
(save and
exit)



Exit
(without
saving)

Input Settings



Access the settings for emissivity, reflected energy compensation, averaging and hold processing.

Emissivity and Compensation



Emissivity

Enter the emissivity of the target. Target emissivity can be determined experimentally, or estimated using an emissivity table. For more information, contact Calex.

Enable Reflected Energy Compensation

If enabled, compensates for errors caused by reflected energy from hotter or colder objects.

Reflected Temperature

Enter the temperature of the surroundings of the target for Reflected Energy Compensation.

Settings

Processing



AVERAGING PERIOD

Set the time, in seconds, over which the measured temperature is averaged. Note: averaging prevents the sensor from following rapid temperature changes. Minimum: 0 (no averaging). Maximum: 60.

HOLD MODE

Peak

The sensor holds the maximum temperature steady for the Hold Period. After this, the sensor responds normally. If the sensor detects a higher temperature, it holds this temperature steady for the Hold Period.

Valley

Similar to Peak Hold mode except that the sensor outputs the minimum detected temperature steady for the Hold Period.

Off

Disables hold processing.

HOLD PERIOD

Set the time, in seconds, for the sensor to hold the temperature as above. Minimum: 0 (no hold processing). Maximum: 1200.

Output Settings

Access settings for current output range, Modbus address, alarms, and temperature display.

4 to 20 mA Output(-CRT models)



Set the temperature range limits for the 4 to 20 mA output.

Temperature at 4 mA

The lower temperature range limit.

Temperature at 20 mA

The upper temperature range limit.

Please note

The difference between the temperatures at 4 mA and at 20 mA must be at least 100°C. The temperature at 20 mA must be greater than the temperature at 4 mA.

Modbus Address (-BRT models)



The Modbus address (Slave ID) of the sensor is displayed. Enter a new address, then tap Apply to save it to the sensor. Cycle the power to use the new address.

Minimum: 1. Maximum: 247.

Alarms



Configure the settings for Alarm 1 and Alarm 2 separately, and configure alarm logging settings.



Manually Reset Alarms

If an alarm has been triggered, allows both alarms to be triggered again. Alarms will not be triggered again until they are reset, either automatically or manually.



Individual settings for each alarm

Alarm Set Point

The temperature at which the alarm is triggered.

Hysteresis

The temperature difference between the Alarm Set Point and the reset temperature. Hysteresis is only used when Automatic Reset is enabled. Please see the Alarm Operation diagrams below for more information.

Minimum: 0°C (hysteresis disabled).

Filtered Temperature or Sensor Temperature (Alarm 2 only)

Select the temperature monitored by Alarm 2.

Alarm Type

High: The alarm is triggered when the temperature rises above the Alarm Set Point.

Low: The alarm is triggered when the temperature drops below the Alarm Set Point.

Off: The alarm is disabled.

Reset

Automatic

The alarm is acknowledged and reset automatically when the temperature reaches the reset temperature (see Hysteresis). It can also be acknowledged or reset manually.

Manual

The alarm is acknowledged by tapping **Acknowledge** on the Temperature View or List View, and reset by tapping **Reset** on the Alarms screen.

Display Options



Select the temperature to be displayed on the Temperature View

Filtered Temp

The measured temperature, with averaging and hold processing. This temperature is output by the sensor on the 4 to 20 mA output (-CB and -CRT models).

Average Temp

The measured temperature with averaging but without hold processing.

Unfiltered Temp

The unprocessed measured temperature.

Data Logging



Sample Period

The time, in seconds, between samples. Minimum: 1. Maximum: 86,400 (1 day).

Number of Samples

The number of samples to collect before logging stops. Minimum: 0 (continuous logging). Maximum: 86,400 (1 day of data if Sample Period = 1 second).

Enable Scheduled Start

The sensor begins logging at the Date and Time specified. Logging can also be started and stopped manually.

Date and Time

The date and time for scheduled logging to start.

Alarm Logging



Alarm events can be logged to the MicroSD Card. Alarm log files and settings are independent from Data Logging.

Log Trigger Time

The time that an alarm is triggered will be logged.

Log Data While Triggered

Data logging will start when an alarm is triggered. 1 sample is logged per second. Logging stops when both alarms are reset.

Log Acknowledge Time

The time that the alarm is acknowledged will be logged.

Log Reset Time

The time that the alarm is reset will be logged.

Date & Time



Date & Time

Change the date and time for data logging purposes.

The clock is reset when the power is switched off, unless a battery is fitted.

Language



Language

Select English, Simplified Chinese or Japanese.

ALARM OPERATION WITH HYSTERESIS & AUTOMATIC RESET

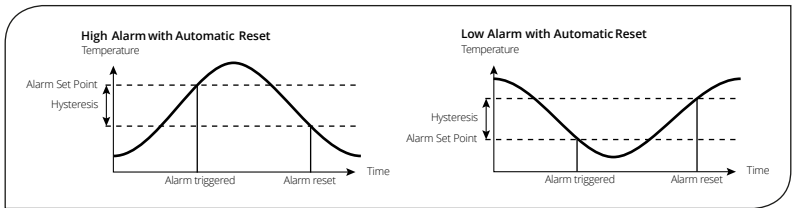

The PyroMini can be used as a standalone data logger.

PyroMini models -CRT and -BRT include a MicroSD card slot for data logging, which can be configured via the touch screen interface. The user can select the sample rate and the number of samples to be taken and schedule the data logging to start at a certain time.

With a 2 GB card, the user can store 28.4 million readings, which provides almost 1 year's worth of data at the fastest possible sample rate of 1 per second.

Data is stored on the MicroSD card in .csv format and can be viewed and edited easily using spreadsheet software.

A MicroSD card with SD card adapter is available as an optional accessory.

The MicroSD card slot and battery holder are located on the touch screen circuit board in the lid of the electronics module. Readings are time and date stamped using the sensor's internal clock. The clock is reset when the power is disconnected, or it will continue if the optional battery is fitted.

DATA LOGGING SPECIFICATIONS

Data Logging Interval	1 to 86,400 seconds (1 day)
MicroSD Card	Max. capacity: 32 GB (not included)
Internal Clock Battery	1 x BR 1225 3V (not included)
Variables Logged	Target temperature, sensing head temperature, electronics module temperature, max, min, average, emissivity setting, reflected energy compensation temperature
File format	.CSV
Configurable Parameters	Sample period, number of samples, scheduled start date and time
Modbus address range	1 to 247

USING THE PYROMINI AS A DATA LOGGER

1. Insert a MicroSD card into the holder on the circuit board inside the lid of the electronics module.
2. To retain the date and time when the sensor is switched off, fit a battery to the holder on the circuit board inside the lid.
3. Replace the lid and connect the sensor power supply.



4. To set the number of samples to be logged, the time period between samples, and, if required, to schedule data logging to automatically start, tap **Settings** to access the Settings menu, then tap **Data Logging** to access the Data Logging options.



5. To save data logging settings, tap **Apply**



6. To manually start data logging, tap **Go** on the TemperatureView or List View.



7. While logging is in progress, the **Logging Icon** flashes on the Temperature View and List View.



8. To stop data logging, tap **Stop**.



9. To transfer data to a computer, remove the MicroSD Card from the sensor, insert the card into the SD Card adapter (supplied with MicroSD Card, accessory model MSD) and insert the adapter into an SD Card reader.

INSTALLATION OF MICROSD CARD AND BATTERY

Underside of touch screen lid

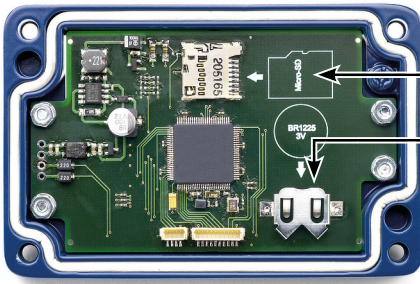

MicroSD Card

Battery
(use 1 x BR 1225 3V)

Data is saved to the MicroSD Card in .csv format. This file format can be opened or imported by spreadsheet software such as Microsoft Excel.

A new folder is created on the MicroSD Card for each day that data is logged.

A new log file is created every time logging is started. The start time is used as the file name.

DIMENSIONS & ACCESSORIES

Electronics Module

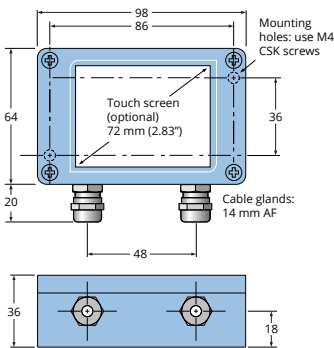

Sensing Head

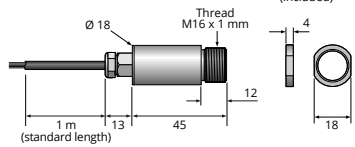

Air Purge Collar

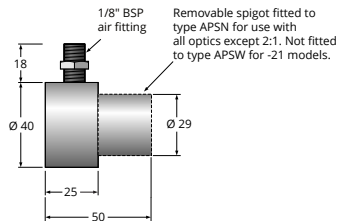

Dimensions in mm unless stated

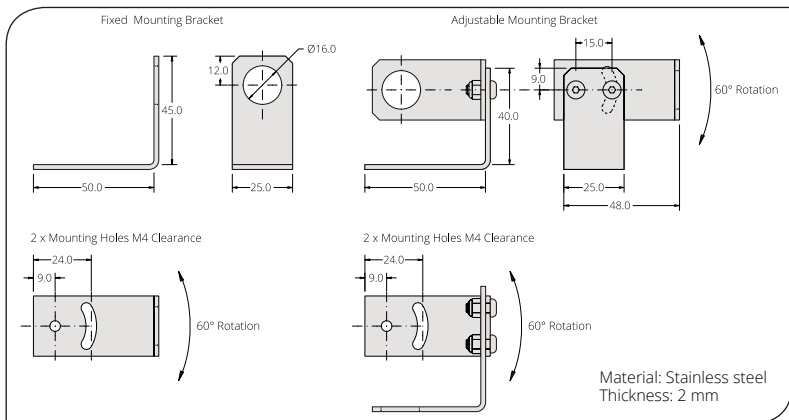

A range of accessories to suit different applications and industrial environments is available. These may be ordered at any time and added on-site. The following accessories are available from Calex:

Fixed mounting bracket (see above for dimensions): Allows rotational adjustment in one dimension. Model number: FBS.

Adjustable mounting bracket (see above for dimensions): Allows rotational adjustment in two dimensions. Model number: ABS.

Air purge collar (see above for dimensions): The air purge collar is used to keep dust, fumes, moisture, and other contaminants away from the lens. It must be screwed fully onto the sensing head. Air flows into the 1/8" BSP fitting and out of the front aperture. Air flow should be 5 to 15 l/min. Clean or 'instrument' air is recommended. Model APSW is for use with sensors with 2:1 optics. Model APSN is for use with all other models.

Laser sighting tool: When fitted to the sensor during installation or re-alignment, the laser sighting tool pinpoints the centre of the measured spot. Model number: LSTS.

MicroSD Card: Stores logged data. For use with -BRT and -CRT models. Includes SD Card adapter. Model number: MSD.

Protective plastic or silicon windows: Helps protect the lens from mechanical or chemical damage. Quick and easy to replace. For use with general-purpose models only. Model number: PWS / SIWS.

Dual laser sighting bracket: Allows continuous laser sighting at the same time as using the sensor. Model number: DLSBFS (fixed), DLSBAS (adjustable)

6-sensor touch screen hub (-BB and -BRT models): Multi-channel temperature display, configuration and logging for up to 6 Modbus sensors. Model number: PM180.

OPTIONS

The following options are available. Options are factory installed and must be ordered with the sensor.

Calibration Certificate: UKAS traceable certificate showing the measured temperature at three points across the sensor's temperature range. Model number: CALCERTA.

Extended Cable (30 m maximum total cable length): 1 m cable is supplied with each sensor as standard. Extra cable can be factory-fitted to this in increments of 1 m. Included in sensor model number.

INSTALLATION

The installation process consists of the following stages:

Preparation

Mechanical installation

Electrical installation

Please read the following sections thoroughly before proceeding with the installation.

PREPARATION

Ensure that the sensor is positioned so that it is focused on the target only.

DISTANCE AND SPOT SIZE

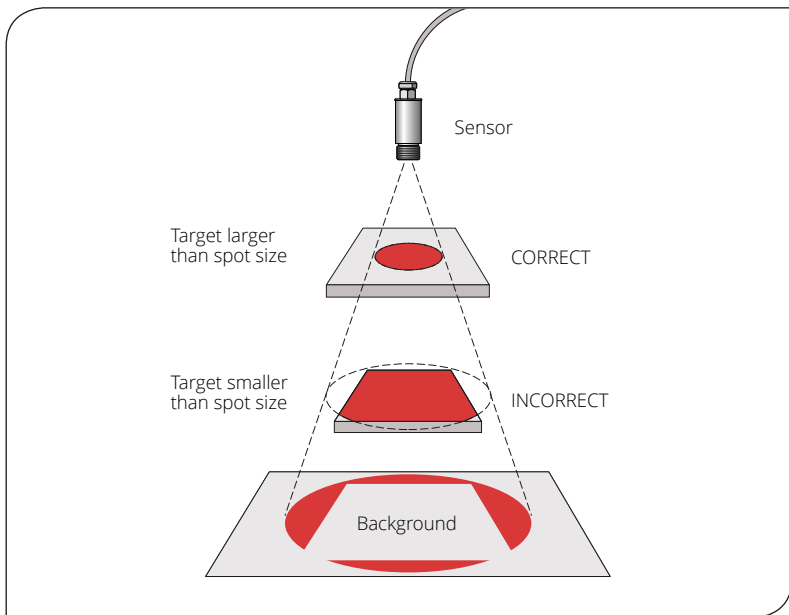

The size of the area (spot size) to be measured determines the distance between the sensor and the target. The spot size must not be larger than the target. The sensor should be mounted so that the measured spot size is smaller than the target.

AMBIENT TEMPERATURE

The sensing head withstands up to 60°C, 70°C, 120°C, or 180°C, without cooling, depending on the sensor model. See "Model Numbers" for more information. Avoid thermal shock. Allow 20 minutes for the unit to adjust to large changes in ambient temperature.

ATMOSPHERIC QUALITY

Smoke, fumes, dust or steam can contaminate the lens and cause errors in temperature measurement. In these types of environment the air purge collar should be used to help keep the lens clean.

INTERFERENCE FROM MOVEMENT

The low-noise sensing head cable on -HA and -JA models is resistant to interference caused by movement. The sensing head may be mounted on moving machinery such as robot arms without affecting the accuracy of the measured temperature.

ELECTRICAL INTERFERENCE

The PyroMini is tested to industrial standards for electromagnetic compatibility (EMC) as shown in Specifications at the beginning of this manual. To minimise electromagnetic interference or 'noise', the sensor should be mounted away from motors, generators and such like.

POWER SUPPLY

Be sure to use a 24 V DC (100 mA) power supply.

MECHANICAL INSTALLATION

The sensor can be mounted on brackets or cut-outs of your own design, or you can use the fixed or adjustable mounting bracket accessories.

GROUNDING

Note: The sensor housing must be connected to earth at one point, either the housing of the sensing head, the electronics module, or the output cable shield termination. To avoid ground loops, please ensure the sensor is grounded at only one of these points.

SENSING HEAD CABLE

All sensors are supplied fitted with a 1 m sensing head cable and a mounting nut as standard. Longer cables are available to order.

The sensing head cable may be temporarily detached from the electronics module for installation. If this is done, it is important to reconnect it properly, as shown on the following pages.



IMPORTANT NOTES

Do NOT open the cable gland on the sensing head itself. This will damage the sensor and void the warranty.

The sensing head cable cannot be shortened or lengthened by the user, as this may affect the measurement accuracy. If you need to modify the length of the sensing head cable, please contact Calex to discuss this.

Ensure power is OFF before starting, and do not reconnect power until all connections have been completed and checked.

DISCONNECTING THE SENSING HEAD CABLE



1. With power off, fully unscrew the outer nut of the cable gland on the electronics module.
Do not open the cable gland on the sensing head itself!

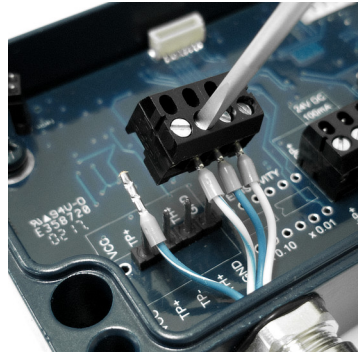

2. The screw terminal block is removable for easy wiring. Pull it upwards to remove it from the board, for easier access to the wires.
3. Unscrew the terminals and carefully pull the ferrules out of the terminal block.
Do not remove the ferrules from the ends of the wires.
4. Carefully pull the wire ends through the disassembled gland.

RECONNECTING THE SENSING HEAD CABLE

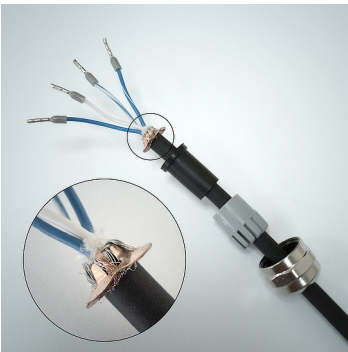

1. Ensure the cable shield braid is folded back over the cable jacket and gripped by the metal shield ring. This ensures a good electrical connection to the cable gland.

2. Thread the wires through the gland and re-connect them to the screw terminals.
For wire identification, see **Sensing Head Cable Colour Codes** opposite.
3. Reassemble the gland and tighten the outer nut. Avoid twisting the cable.
4. Ensure the screw terminal blocks are attached to the correct pins before applying power.

ELECTRICAL INSTALLATION

CONNECTIONS

-CB and -CRT models

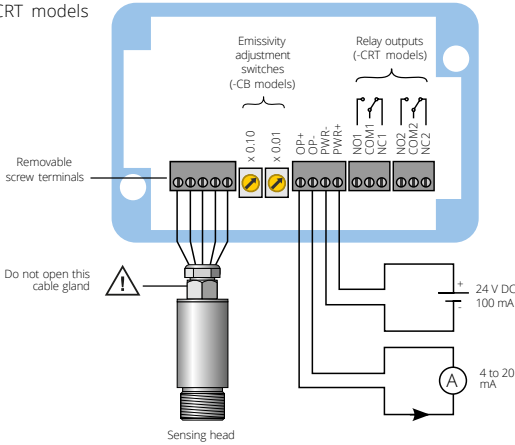

Sensing Head Cable Colour Codes

Depending on the sensing head type, there will be 4 or 5 wires, with the following combinations of colour codes:

Terminal label	Colours	
TP+	Yellow	Blue with white line
TP-	Green	White with blue line
TH+	Brown/Red	Blue
GND	White	White
VCC	Grey (PyroMini 2.2 only)	

-BB and -BRT models

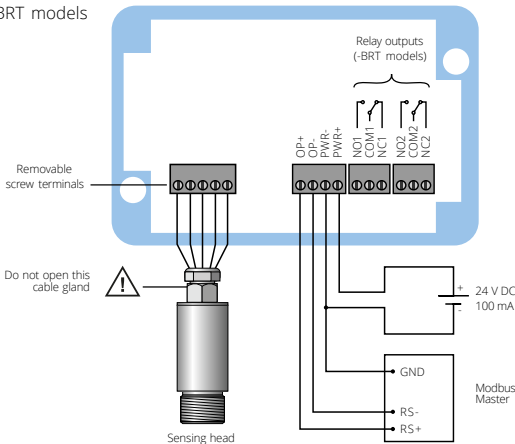

WIRING (ALL MODELS)

Check the distance between the sensing head and the electronics module, and between the electronics module and the instrumentation. If necessary, the sensor can be ordered with a longer cable between the sensing head and the electronics module.

Do not extend or shorten the sensing head cable. The head and electronics module are calibrated as a pair, and modifying the sensing head cable can affect the measurement accuracy. Contact Calex for assistance.

The output cable from the electronics module should have an outer diameter between 3.0 and 6.5 mm, with conductors of size 28 to 18 AWG.

The terminal blocks in the electronics module may be removed from the circuit board for easy wiring.

Do not connect or disconnect the touch screen circuit board from the main circuit board while the sensor is on.

WIRING (-BB AND -BRT MODELS)

When connecting several sensors in a single Modbus network, all of the sensors should be connected via a junction box to a single network bus cable, running from the furthest sensor to the Modbus Master.

Up to 247 sensors may be connected to a single Modbus network. Each sensor must have a unique Modbus address. The Modbus address may be changed via the touch screen interface on -BRT models, or via Modbus.

To help prevent data reflections, please ensure the cable between each sensor and the main network bus is as short as possible. The network bus should be terminated with a resistor of 120 Ω between the RS+ and RS- wires. The PWR- wire of the bus should be connected to the signal ground of the Modbus Master.

MODBUS OVER SERIAL LINE (RS485)

Interface	
Baud rate	9600*
Format	8 data, No parity, 1 stop bit*
Reply delay (ms)	20
Supported functions	
Read register	0x03, 0x04
Write single register	0x06
Write multiple register	0x10
Mask write register	0x16
Read/write	0x17

* Other configurations available on request.

LIST OF MODBUS REGISTERS

The following list includes all available addresses.

R = Read **W** = Write (single, multiple or read/write) **MW** = Mask write

Address	Length (words)	Description	R/W/MW															
0x00	1	MODBUS slave address	R/W*															
0x02	2	Sensor identification register Bits 0..19 - Serial number Bits 20..23 - Sensor type (12 = PyroMini, 14 = PyroMini 2.2) Bits 24..26 - Optics: <table border="1"> <tr> <td>PM-MA</td> <td>PM-JA & HA</td> <td>PM2.2</td> </tr> <tr> <td>0 = 2:1</td> <td>0 = 20:1</td> <td>0 = x51-MT</td> </tr> <tr> <td>1 = 15:1</td> <td></td> <td>1 = x51-HT</td> </tr> <tr> <td>2 = 30:1</td> <td></td> <td>2 = 151-LT</td> </tr> <tr> <td></td> <td></td> <td>3 = 151-PT</td> </tr> </table> Bits 28..32 - Reserved	PM-MA	PM-JA & HA	PM2.2	0 = 2:1	0 = 20:1	0 = x51-MT	1 = 15:1		1 = x51-HT	2 = 30:1		2 = 151-LT			3 = 151-PT	R
PM-MA	PM-JA & HA	PM2.2																
0 = 2:1	0 = 20:1	0 = x51-MT																
1 = 15:1		1 = x51-HT																
2 = 30:1		2 = 151-LT																
		3 = 151-PT																
0x06	1	Unfiltered object temperature	R															
0x08	1	Sensor temperature	R															
0x0A	1	Maximum temperature over hold period	R															
0x0C	1	Minimum temperature over hold period	R															
0x0E	1	Average temperature over hold period	R															
0x10	1	Filtered object temperature	R															
0x12	1	PCB temperature	R															
0x14	1	Emissivity (1 LSB = 0.0001) Minimum 0.2000, Maximum 1.0000	R/W															
0x16	1	Reflected temperature	R/W															
0x18	1	Sensor status register Bits 0..1 - Reserved Bit 2 - Hold processing on (1) / off(0) Bit 3 - Hold peaks (1) / valleys (0) Bits 4..6 - Reserved Bit 7 - Reflected energy compensation on (1) / off (0) Bits 8..15 - Reserved	R/W/MW															
0x1A	1	Average period (1 LSB = 0.05 seconds) Minimum 0.05 seconds, Maximum 60.00 seconds	R/W															
0x1C	1	Hold period (1 LSB = 0.05 seconds) Minimum 0.05 seconds, Maximum 1200.00 seconds	R/W															
0x1E	1	Temperature at 4 mA PM: Minimum -20°C, Maximum 900°C PM2.2: Minimum 100°C, Maximum 1900°C	R/W															
0x20	1	Temperature at 20 mA PM: Minimum 80°C, Maximum 1000°C PM2.2: Minimum 200°C, Maximum 2000°C	R/W															

LIST OF MODBUS REGISTERS (CONTINUED)

Address	Length (words)	Description	R/W/MW
0x22	1	Alarm 1 setpoint Minimum -20°C, Maximum 1000°C Minimum 100°C, Maximum 2000°C	R/W
0x24	1	Alarm 1 hysteresis PM: Minimum 0°C, Maximum 1000°C PM2.2: Minimum 0°C, Maximum 1550°C	R/W
0x26	1	Alarm 1 status register Bit 0 – Relay triggered (R) Bit 1 – Visible alarm active (R) Bit 2 – Alarm triggered (R) Bit 3 – Auto reset (1) / manual reset (0) (R/W/MW) Bit 4 – Alarm acknowledge (R/W/MW) Bit 5 – Alarm reset (R/W/MW) Bits 6..7 – Reserved Bit 8 – High alarm (1) / low alarm (0)(R/W/MW) Bit 9 – Alarm enabled (1) / disabled (0) Bits 10..15 – Reserved	R/W/MW
0x28	1	Alarm 2 status register Bit 0 – Relay triggered (R) Bit 1 – Visible alarm active (R) Bit 2 – Alarm triggered (R) Bit 3 – Auto reset (1) / manual reset (0) (R/W/MW) Bit 4 – Alarm acknowledge (R/W/MW) Bit 5 – Alarm reset (R/W/MW) Bit 6 – Reserved Bit 7 – Filtered object temperature (1) / head temperature(0) (R/W/MW) Bit 8 – High alarm (1) / low alarm (0)(R/W/MW) Bit 9 – Alarm enabled (1) / disabled (0) Bits 10..15 – Reserved	R/W/MW
0x2A	1	Alarm 2 setpoint PM: Minimum -20°C, Maximum 1000°C PM2.2: Minimum 100°C, Maximum 2000°C	R/W
0x2C	1	Alarm 2 hysteresis PM: Minimum 0°C, Maximum 1000°C PM2.2: Minimum 0°C, Maximum 1550°C	R/W

*Single register writes only. New address will not take effect until next power on.

Notes:

1. All temperatures are in tenths of degrees C
2. Writing to unlisted registers could cause malfunction
3. All write and mask operations are saved to non-volatile memory
4. For further information please refer to <http://www.modbus.org/specs.php>
5. Use address 255 to communicate with any connected sensor. Use address 0 to broadcast to all connected sensors (no response expected)

OPERATION

Once the sensor is in position and the appropriate power, air and cable connections are secure, the system is ready for continuous operation by completing the following simple steps:

1. Turn on the sensor power supply
2. Turn on the connected instrumentation
3. Read, monitor or log the temperature

IMPORTANT

Be aware of the following when using the sensor:

1. If the sensor is exposed to significant changes in ambient temperature (hot to cold, or cold to hot), allow 20 minutes for the temperature to stabilise before taking or recording measurements.
2. Do not operate the sensor near large electromagnetic fields (e.g. around arc welders or induction heaters). Electromagnetic interference can cause measurement errors.
3. Wires must be connected only to the appropriate terminals.

VIEWING THROUGH A WINDOW

The sensor is capable of measuring the temperature of a target through a window made of a material that is transmissive to infrared radiation at 8-14 μm (PM models) or 2.0-2.6 μm (PM2.2 models). The emissivity setting of the sensor should be adjusted to compensate for the presence of the window. Please contact Calnex for more information on using the sensor with a window.

MAINTENANCE

Our customer service representatives are available for application assistance, calibration, repair, and solutions to specific problems. Contact our Service Department before returning any equipment. In many cases, problems can be solved over the telephone. If the sensor is not performing as it should, try to match the symptom in "TROUBLESHOOTING" to the problem. If the table does not help, call Calnex for further advice.

LENS CLEANING

Keep the lens clean at all times. Any foreign matter on the lens would affect measurement accuracy. Blow off loose particles (if not using the air purge accessory) with an air 'puffer'.

TROUBLESHOOTING

Symptom	Probable Cause	Solution
No output	No power to sensor	Check power supply and wiring
Inaccurate measured temperature	Target too small for sensor's field of view	Ensure the sensor's view is completely filled by the target. Position the sensor closer to the target to measure a smaller area Ensure the target is at least twice the size of the given measured spot
	Target is a reflective metal surface	PyroMini 2.2 models: Adjust the emissivity setting to match the target emissivity PyroMini (8-14 μm) models: Measure a non-reflective area, or paint or coat a measurable area of the target to make it non-reflective
	Field of view obstruction	Remove obstruction; ensure sensor has a clear view of target
	Dust or condensation on lens	Ensure lens is clean and dry. Clean gently with a soft lens cloth and water. If problem recurs, consider using an air purge collar
	Output temperature scale mismatch (when reading 4-20 mA output with an external indicator or controller)	Re-scale input temperature range on measurement instrument to match sensor. Use touch screen interface to check output temperature range
	Sensing head cable has been disconnected at electronics module during installation, and then reconnected	Check sensing head wires are connected correctly in electronics module (see colour codes listed in CONNECTIONS). Ensure cable shield is properly terminated in cable gland at electronics module
Cannot access Settings menu	Touch screen interface is locked	Unlock sensor via the Lock/Unlock screen. The default password is 1234.

GUARANTEE

Calex guarantees each instrument it manufactures to be free from defect in material and workmanship under normal use and service for the period of two years from the date of purchase. This guarantee extends only to the original buyer according to Calex terms and conditions of Sale.

Issue J - Aug 2021