

PyroCube

Infrared Temperature Sensor

PM030

Touch Screen Interface Module



PYROCUBE

The PyroCube is a non-contact infrared temperature sensor with built-in LED sighting. It has an extremely fast response time, and can precisely measure the temperature of a very small area.

The continuous LED sighting illuminates the position and size of the measurement spot while readings are being taken, without affecting the accuracy of the measurement.

The sensor works by detecting the infrared radiation emitted from a surface as a result of its own temperature. The amount of radiation emitted is related to the temperature, and the sensor uses this relationship to provide an accurate temperature measurement.

Each PyroCube sensor suits a different application:

Model PCU-	Application
S	General purpose. Suitable for measuring non-metals such as paper, thick plastics, food, rubber, electronic components, cable insulation, ceramics, textiles, painted surfaces among many others
F	Fastest response time (1 millisecond)
G, GH	Special wavelength for measuring the surface temperature of glass with minimal interference from reflections
MA, MB	Short measurement wavelength, for reflective metals at low temperatures
XSA, XSB	Extremely small measured spot size – as small as 0.7 mm
P	Special measurement wavelength for thin-film plastics

PM030

The PM030 is an optional multilingual touch screen interface module for the PyroCube sensor. The PyroCube can be used with or without the optional PM030. It functions as a standalone temperature indicator, alarm unit and configuration tool, and a selectable analogue output allows it to be connected to further instrumentation.

All the settings of the PyroCube sensor are adjustable via the built-in touch screen interface.

When an optional MicroSD Card is inserted into the PM030, the system functions as a fully-configurable temperature data logger.

PYROCUBE SENSOR SPECIFICATIONS

Measurement

	Sensor Model	Specification
Temperature Range	S	0°C to 500°C
	F, XSA	50°C* to 500°C
	XSB	100°C* to 500°C
	G	100°C* to 1200°C
	GH	100°C* to 2400°C
	P	120°C* to 350°C
	MA, MB	100°C* to 600°C

Analogue Output Scale	All models	Adjustable via optional touch screen module or RS232. Factory set to:
	S, F, XSA, XSB	4 mA = 0°C 20 mA = 500°C
	P	4 mA = 80°C 20 mA = 350°C
	G	4 mA = 50°C 20 mA = 1200°C
	GH	4 mA = 50°C 20 mA = 2400°C
	MA, MB	4 mA = 50°C 20 mA = 600°C
Response time (95% of step change)	S, GH, P, XSA	10 ms to 5 s (adjustable via averaging)
	F, MA, MB	1 ms to 5 s (adjustable via averaging)
	G, XSB	50 ms to 5 s (adjustable via averaging)
Target sighting	All models	Red LED built-in as standard. Indicates the measured spot size. Switchable on/off.
Measurement Accuracy**	S, G, MA, MB, XSA	± 3°C or 1%, whichever is greater
	GH	As above except ± 2% above 1200°C
	F	± 3.5°C or 1%, whichever is greater
	P	± 4°C
	XSB	± 5°C
Repeatability**	S	± 0.5°C
	G, P, XSA, F	± 1°C
	GH, MA, MB	± (0.2% + 2°C)
	XSB	± 2°C
Resolution**	S	< 0.5°C
	F	0.7°C
	G, GH, MA, MB, P, XSA	0.5°C
	XSB	1.5°C
Emissivity setting	Adjustable 0.3 to 1.0 via RS232C or optional touch screen interface. MA, MB models: For measurements above 100°C, emissivity can be adjusted as low as 0.05.	
Optics	See Field of View Diagrams	

* Measurements at lower temperatures are possible with reduced stability.

** Ambient temperature 23 ± 5°C, emissivity 1.0, averaging time 0.05 s

Electrical

Outputs	1 analogue output and 1 alarm output
Analogue output	4-20 mA (set by default), 0-20 mA, mV/°C or voltage‡, selectable via optional touch screen interface.
Alarm output	1 open drain alarm output, rated 27 V DC, 0.2 A
Supply voltage (sensor)	5 to 27 V DC, 100 mA max
Digital Communications	RS232C Modbus RTU, non-isolated

‡ Voltage can be 0-1, 0-5, or 0-10 V DC, depending on model (see Model Numbers).

Mechanical

Weight (without cable)	S, F, G, MB, P, XSB	85 g
	GH, MA, XSA	190 g

Environmental

Environmental rating	IP67
Operating ambient temperature	0°C to 50°C
Storage temperature	-15°C to 70°C
Operating ambient humidity	30% to 85% RH non condensing

Display

Optional PM030 touch screen interface module for indication, configuration, data logging and alarm outputs

Electromagnetic Compatibility Standards

EMC Directive	EN61326-1:2013
CISPR 11:2009	Industrial and scientific equipment – Emissions test
IEC61000-4-2	Electrostatic Discharge Immunity
IEC61000-4-3	Electromagnetic Field Immunity
IEC61000-4-4	Burst Immunity
IEC61000-4-5	Surge Immunity
IEC61000-4-6	Conducted RF Immunity

PM030 TOUCH SCREEN INTERFACE MODULE SPECIFICATIONS

Electrical

Supply Voltage	24 V DC \pm 5%
-----------------------	------------------

Interface

Display Format	2.83" (72 mm) resistive touch TFT, 320x240 pixels, backlit
Configurable Parameters	Language (English, Chinese, Japanese) Temperature units Displayed temperature (instantaneous, hold) LED sighting on/off Password Date & time (for data logging time stamps) Peak hold period, discharge level Averaging period Correction (gain/offset) Emissivity setting (with teach function) Reflected energy compensation (with teach function) Output type Output temperature range Polarity on error Alarm mode, levels, hysteresis

Data Logging

Storage	MicroSD Card (optional), max. 32 GB, equal to 16 years of data at the fastest sample rate of 1 per second	
Sample Interval	1 second to 1 day (configurable)	
Internal Clock Battery	1 x BR 1225, 3 V (not included)	
Variables Logged	Unfiltered temperature, hold temperature, alarm events	
Configurable Parameters	Data logging:	Sample period Number of samples Scheduled start
	Alarm logging:	Log times when triggered, acknowledged, reset Log data while triggered

Outputs

Outputs	2 x alarm relay outputs rated 24 V DC, 1 A; Retransmitted analogue output from sensor
----------------	--

Retransmitted Analogue Outputs

Output Type	Effective Minimum Output	Output Accuracy (additional to Measurement Accuracy)
0 to 1 V DC	30 mV	\pm 1.5 mV
mV/°C	30 mV	\pm 1.5 mV
0 to 20 mA	0.2 mA	\pm 0.02 mA
4 to 20 mA	4.0 mA	\pm 0.02 mA

PCU - S1.6 - 2M - 1V

VOLTAGE OUTPUT OPTION

1V = 0 to 1 V DC

5V = 0 to 5 V DC

10V = 0 to 10 V DC

Note: All models also have 0-20 mA, 4-20 mA, and mV/°C outputs as standard. Output is factory set to 4-20 mA by default on all models.

CABLE LENGTH

2M = 2 metres

5M = 5 metres

10M = 10 metres

APPLICATION AND OPTICS

General Purpose

S1.6 = 1.6 mm measured spot diameter at 35 mm distance

S3.0 = 3 mm measured spot diameter at 70 mm distance

S5.5 = 5.5 mm measured spot diameter at 120 mm distance

Fast Response

F3.5 = 3.5 mm measured spot diameter at 100 mm distance

F7.0 = 7 mm measured spot diameter at 200 mm distance

Glass

G7.0 = 7 mm measured spot diameter at 180 mm distance

G20.0 = 20 mm measured spot diameter at 500 mm distance

GH2.2 = 2.2 mm measured spot diameter at 150 mm distance

GH4.5 = 4.5 mm measured spot diameter at 300 mm distance

Thin Film Plastics

P12.0 = 12 mm measured spot diameter at 200 mm distance

Very Small Measured Spot

XSA0.7 = 0.7 mm measured spot diameter at 40 mm distance

XSB1.0 = 1 mm measured spot diameter at 100 mm distance

Metals

MA1.0 = 1 mm measured spot diameter at 50 mm distance

MA2.0 = 2 mm measured spot diameter at 100 mm distance

MA3.5 = 3.5 mm measured spot diameter at 200 mm distance

MB11.0 = 11 mm measured spot diameter at 200 mm distance

SERIES

PCU = PyroCube sensor

PM030

Touch screen interface module, compatible with all PyroCube sensor models

FIELD OF VIEW DIAGRAMS

Diagrams show the diameter of the measured spot at each distance, for 90% energy. The accuracy specifications for the PyroCube sensor are valid up to the maximum distances shown.

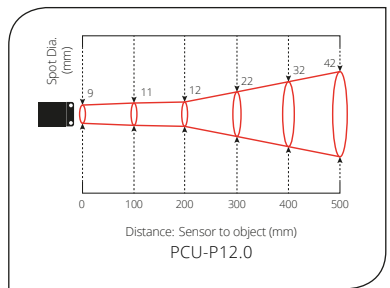
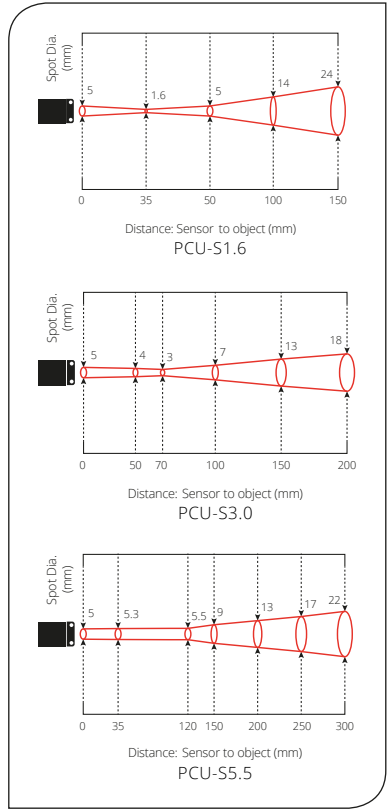
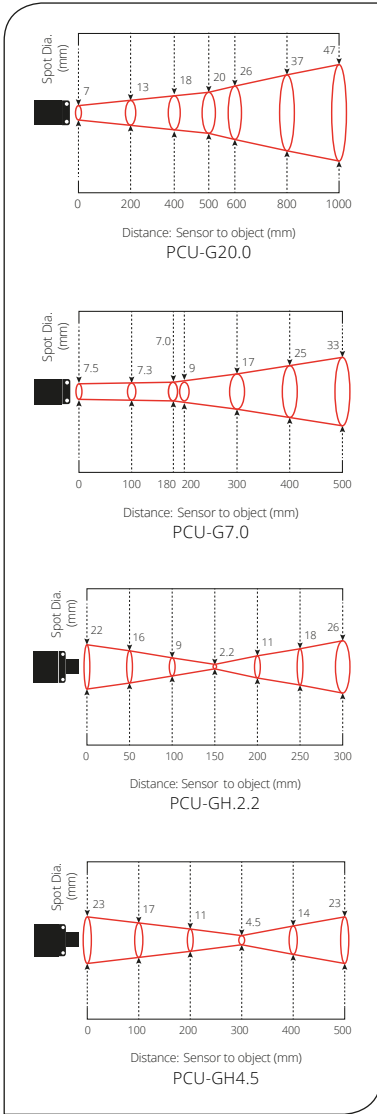

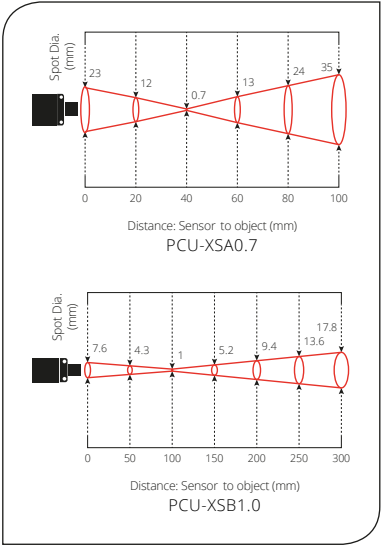
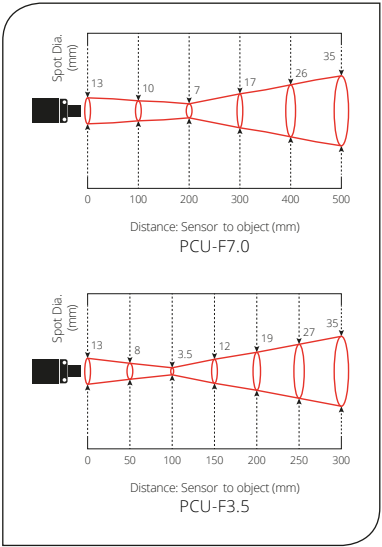
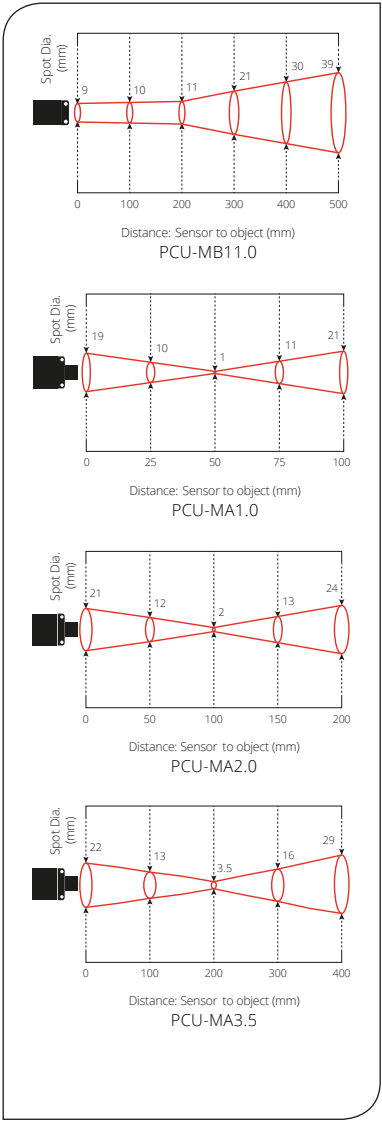

EMISSIONITY ADJUSTMENT

The default emissivity setting is 0.95. It may be adjusted in two ways via the touch screen interface:

Settings → Input Settings → Emissivity & Compensation → Emissivity & Compensation Settings

Enter the target emissivity here. For help with finding the target emissivity, contact Calex.

Settings → Input Settings → Emissivity & Compensation → Teach Emissivity

Measure the true surface temperature using another device, such as a trusted contact thermometer. Enter the true temperature here, and the sensor calculates the correct emissivity setting.

To use this function, the target temperature must be greater than 50°C.

REFLECTED ENERGY COMPENSATION

Settings → Input Settings → Emissivity & Compensation → Emissivity & Compensation Settings

Some of the infrared energy detected by an infrared temperature sensor is not emitted by the target, but is a reflection of its surroundings.

To ensure an accurate reading, the sensor needs to know the temperature of the source of that reflected energy. In most applications, the surroundings of the target have the same temperature as the sensor itself (e.g. the sensor and target are in the same room). The sensor automatically compensates for the reflected energy, so Reflected Energy Compensation is not required.

However, in some applications, the source of the reflected energy (the surroundings of the target) is much hotter or colder than the sensor itself. In these cases, Reflected Energy Compensation should be enabled.

For example, if the target is inside a furnace and the sensor is outside, the reflected energy is coming from the inner walls of the furnace. Use the Teach Reflected Temperature function to find the correct setting. Enter the true target temperature and the sensor will compensate for the reflected energy.

For assistance, contact Calex.

ALARM OUTPUTS

When used without the optional PM030 interface module, the sensor has one open drain alarm output, configurable via RS232C Modbus. The output is rated 27 V DC, 0.2 A.

The PM030 has two individually-configurable alarm relay outputs. These are rated 24 V DC, 1 A. These are individually configurable via the touch screen interface.

Each alarm has two set point temperatures (Low and High). The behaviour of the alarm depends on the Alarm Mode:

Alarm Mode	Low Set Point		High Set Point
	← Low	Measured Temperature	High →
High On			ALARM ON
High Off	ALARM ON		
Low On	ALARM ON		
Low Off	ALARM ON		
Band On		ALARM ON	
Band Off	ALARM ON		ALARM ON
Error On	ALARM ON		
Error Off			

For “Error On” and Error Off” alarms, the alarm monitors for an internal voltage abnormality. In the event of such an error, an “Error On” alarm will be ON and an “Error Off” alarm will be OFF.

PM030 TOUCH SCREEN INTERFACE MODULE

The backlit touch screen interface module provides a large, bright display of the measured temperature, two alarm relay outputs, and options for full configuration of the sensor.

The graph view shows the history of the measured temperature. In alarm conditions, the display changes colour to provide an immediate and obvious alarm indication. Alarm modes and levels can be configured via the touch screen.

Main Screen (Temperature View)

Displays a large indication of the measured temperature. The background turns bright red when an alarm is activated.



MicroSD Card Status

This icon is displayed when a MicroSD card is inserted, and flashes when data logging is in progress.



Scheduled Logging

This icon is displayed when scheduled data logging is enabled and has yet to begin.

Temperature Units °C and °F

Press "°C" to switch to °F and vice versa. The units are changed throughout the interface.

Display Options

Press the measured temperature to select which reading is shown:

Hold Temperature: The measured temperature, with averaging and hold processing.

Unfiltered Temperature: The unprocessed measured temperature.



Sighting On/Off

Switches the LED sighting light on or off. The light does not affect the measurement accuracy.



Start/Stop Logging

Manually begins or ends data logging (requires MicroSD Card, available separately).

If Scheduled Start is enabled in Settings > Data Logging, then logging cannot be started manually.



To manually start logging, you must first disable Scheduled Start.



Acknowledge Alarms

Switches the relay outputs for triggered alarms to their normal, untriggered state. The background of the Temperature View and Graph screen will stay red, and the alarms will not be triggered again until they are reset (see "Alarms" below). Alarms can be acknowledged while the display is locked.

Lock/Unlock



Prevents settings being changed via a four-digit numerical code. To unlock the sensor, enter the password and press the Unlock icon. **The default password is 1234.**



Change Password

Enter, confirm and save a new four-digit code.

Graph



Displays the recent history of the Filtered Temperature and the Sensor Temperature. To scroll backwards and forwards in time, touch the graph and drag it. The graph stores the most recent 24 hours of temperature data.



Reset Graph

Clears and restarts the graph.



Return to Scrolling View

Returns the graph to the real-time scrolling view, showing the most recent measurements.

Settings

Settings



Input Settings

These settings affect the sensor and the measured temperature.



Output Settings

These settings affect the PM030's analogue retransmission output, and the alarm relays.



Date & Time

Change the date and time for data logging purposes.

The clock is reset when the power is switched off, unless a battery is fitted.



Data Logging

Configure the storage of temperature data and alarm events. A MicroSD Card (optional) must be inserted to use these features.



Language

Change the language of the interface. Select from English, Japanese and Simplified Chinese.

Settings → Input Settings



Emissivity & Compensation



Emissivity & Compensation Settings

Emissivity Setting

Enter the emissivity of the target surface. The emissivity setting should match the target emissivity for maximum accuracy.

Enable Reflected Energy Compensation

Select to enable Reflected Energy Compensation, which improves the measurement accuracy if there is significant reflected energy, for example when measuring an object inside a furnace with the sensor positioned outside.

In most applications, this setting should be disabled.

For more information, see the “Reflected Energy Compensation” section of this guide.

Reflected Value

If reflected energy compensation is required, enter the temperature of the surroundings of the target here.



Teach Emissivity

Enter the true temperature of the target here, and the sensor will automatically determine the emissivity setting. For more information, see the “Emissivity Adjustment” section of this guide.



Teach Reflection Value

Enter the true temperature of the target here, and the sensor will automatically compensate for reflected energy. For more information, see the “Reflected Energy Compensation” section of this guide.



Peak Hold

With Peak Hold, the sensor will continue to display or output a peak in the measured temperature for a certain time. This feature is ideal for monitoring the temperature of individual objects on a conveyor, and for ignoring unwanted low readings, such as when a rotating stirring arm in a container of liquid passes the sensor.

Reset

The peak hold mode. Choose from Time or Discharge:

Time

The output returns instantly to the measured temperature after the Reset/Discharge Time.

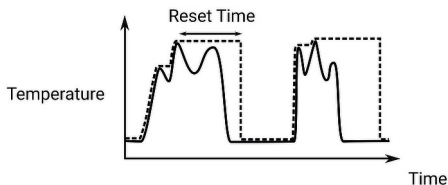

Discharge

The output decreases steadily after a peak. The rate of decay depends on the Reset/Discharge Time and the Discharge Level.

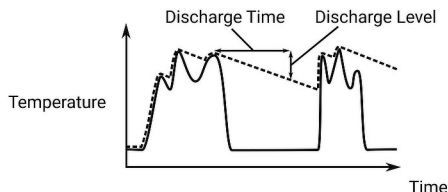

Reset/Discharge Time

The peak hold period. This depends on the “Reset” setting.

Discharge Level

In “Discharge” mode, this is the percentage of the measured temperature that the peak hold temperature will reach after the Reset/Discharge Time has elapsed.

Discharge Level has no effect when “Time” mode is enabled.

Peak Hold Off/On

Enable or disable peak hold processing.



Averaging

Select the required averaging period to smooth the output and slow down the sensor's response time. The default setting is 50 ms.

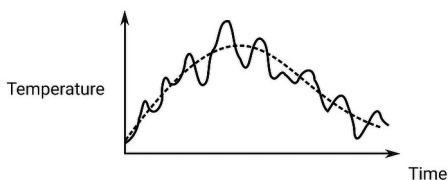

Note: averaging prevents the sensor from following rapid temperature changes.



Correction

Correction Span

Adjusts the gain (slope) of the sensor's measured temperature response. For example, this can be used when measuring through a window to correct for transmission loss.

The sensor is calibrated in the factory and this setting should not normally be adjusted.

Note: When Correction Span is set lower than 0.9, the upper limit of the temperature range is reduced below the published specification.

Correction Offset

This value is added to the measured temperature.

Settings → Output Settings



Output Type

Select the analogue output type:

4-20 mA - this is the default setting.

0-20 mA

Voltage - the output voltage range is 0-1, 0-5, or 0-10 V DC depending on the model.

mV/°C

No output – disable the analogue output.



Output Range

Re-scale the **Lower Limit** and **Upper Limit** of the full range of the analogue output. The output is linear between these temperatures. See “Analogue Output”.

e.g. 4 mA output at 0°C; 20 mA output at 500°C.



Output Temperature

Select whether the hold processing settings should be applied to the output temperature.

Unfiltered Temperature

No processing is applied to the output temperature. The raw measured signal is output from the sensor.

Hold Temperature

The peak hold function is applied to the output temperature.

Note: This function is independent from the displayed temperature (see Display Options near the beginning of this table).



Polarity on Error

Determines whether the sensor output will default to the upper or lower limit in a fault condition (internal voltage abnormality).

Untreated

In a fault condition, the sensor will not change output behaviour.

Upper Limit

In a fault condition, the sensor will default to the upper output limit.

Lower Limit

In a fault condition, the sensor will default to the lower output limit.

Settings → Output Settings → Alarms



Alarms

The settings for the Alarm 1 and Alarm 2 relay outputs are configured individually.



Alarm Mode

High On - The alarm is active above the Alarm High temperature.

High Off - The alarm is active below the Alarm High temperature.

Low On - The alarm is active below the Alarm Low temperature.

Low Off - The alarm is active above the Alarm Low temperature.

Band On - The alarm is on between the Alarm Low and High temperatures.

Band Off - The alarm is on below the Alarm Low temperature and above the Alarm High temperature.

Error On - The alarm is active in a fault condition (internal voltage error).

Error Off - The alarm is active in a normal (non-fault) condition.

For more information, see the section "Alarm Outputs".



Alarm Settings

Alarm Low / Alarm High

Each alarm has two temperature set points: High and Low. Depending on the Alarm Mode, either one or both of these set points will be used to activate the alarm.

Hysteresis

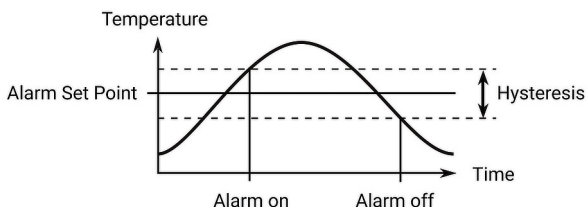

Example: High On alarm with Hysteresis

Hysteresis is the temperature difference between "alarm on" and "alarm off". It is a band centred on the alarm setpoint temperature. The value of Hysteresis is the size of this temperature band.

Settings → Data Logging



Data Logging Settings

Sample period

The time, in seconds, between samples.

Number of samples

The number of samples the unit will collect before logging stops. Enter "0" to log data continuously until manually stopped.

Enable Scheduled Start

The sensor begins logging at the Date and Time specified. Logging can also be started and stopped manually.

Date and Time

The date and time for scheduled logging to start.



Alarm Logging Settings

Alarm events can be logged to the MicroSD Card. Alarm log files and settings are independent from Data Logging.

Log Trigger Time

The time that an alarm is triggered will be logged.

Log While Triggered

Data logging will start when an alarm is triggered. 1 sample is logged per second. Logging stops when both alarms are reset.

Log Acknowledge Time

The time that the alarm is acknowledged will be logged.

Log Reset Time

The time that the alarm is reset will be logged.

DATA LOGGING

The PyroCube and PM030 can be used as a standalone data logger. Data logging can be configured via the touch screen interface.

Data is stored on a MicroSD card in .csv format and can be viewed and edited easily using spreadsheet software. The MicroSD card is available as an optional accessory, with an SD Card adapter to transfer data to a PC.

With a 2 GB card, the user can store 28.4 million readings, which is almost 1 year's worth of data at 1 sample per second. Larger cards provide more storage.

The MicroSD card slot and battery holder are located on the touch screen circuit board in the lid of the PM030. Readings are time and date stamped using the unit's internal clock. The clock is reset when the power is disconnected, or it will continue if the optional battery is fitted.

USING THE PM030 AS A DATA LOGGER

1. Insert a MicroSD card into the holder on the circuit board inside the lid of the PM030.

2. To retain the date and time when the unit is switched off, fit a battery to the holder on the circuit board inside the lid.

3. Replace the lid and connect the sensor power supply.

4. To configure the data logging settings, first unlock the display, then go to

Settings  then **Data Logging** .

5. To save data logging settings, tap **Apply** .

6. To manually start data logging, go back to the Temperature View and tap **Start**

Logging .

7. While logging is in progress, the logging icon  flashes on the Temperature View.

8. To stop data logging, tap **Stop Logging** .

9. To transfer data to a computer, remove the MicroSD Card from the unit, insert the card into the SD Card adapter (supplied with the MicroSD Card, accessory model MSD) and insert the adapter into an SD Card reader.

INSTALLATION OF MICROSD CARD AND BATTERY

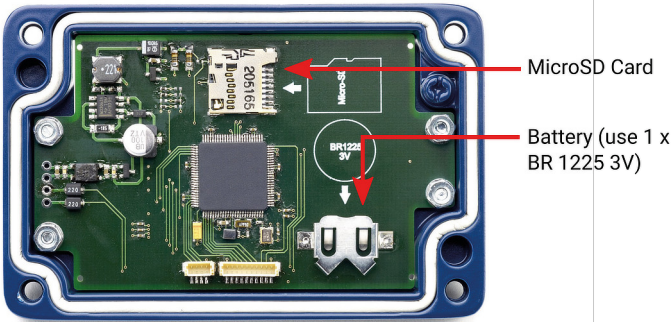

The MicroSD Card and battery slots are located on the touch screen circuit board. Unscrew the lid of the PM030 to access them.

The battery is optional. With a battery fitted, the internal clock will continue to run when the power is off. Without a battery, the unit will request the date and time each time the power is cycled.

All other settings are stored in permanent memory and will be preserved when it is switched off, regardless of whether a battery is fitted.

DATA LOG FILES

Data is saved to the MicroSD Card in .csv format. This file format can be opened or imported by spreadsheet software such as Microsoft Excel.

A new folder is created on the MicroSD Card for each day that data is logged.

A new log file is created every time logging is started. The start time is used as the file name.

DIMENSIONS

PyroCube Dimensions
Models F, G, MB, P, S, XSB

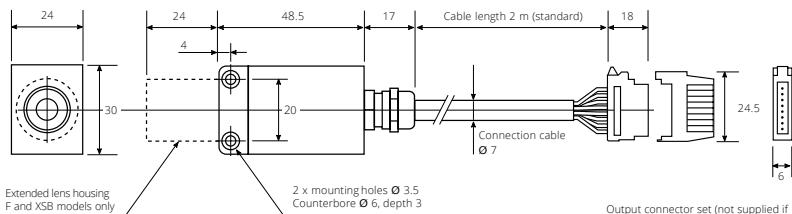

PyroCube Dimensions
Models GH, MA, XSA

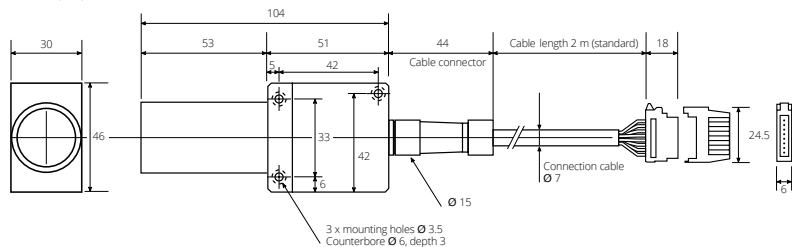

PM030 DIMENSIONS

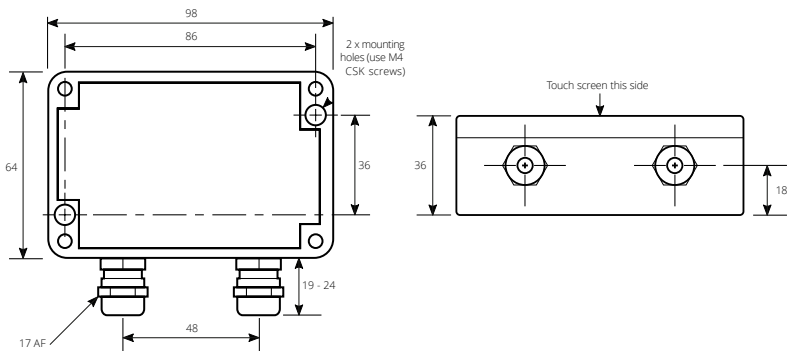

ACCESSORIES



Mounting Bracket for PyroCube F, G, MB, P, S, XSB

Provides a sturdy mount for the sensor and allows rotation about one axis.

Thickness: 2.0 mm. Weight: 45 g.

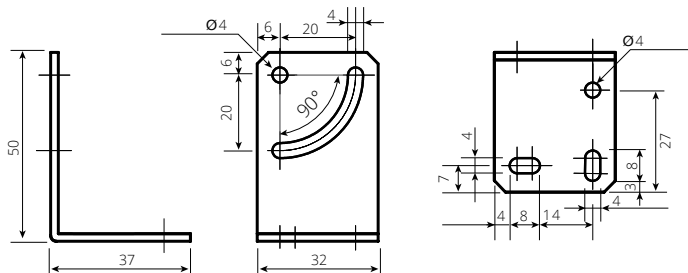

Air Purge Collar

Helps prevent dust and condensation from settling on the lens.

Use clean (instrument) air. Maximum flow rate: 5 l/min, maximum pressure 0.2 MPa.

APC (for PyroCube S, G, P, MB)

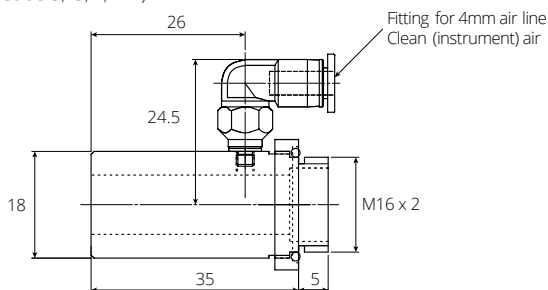

APCF (for PyroCube F, XSB)

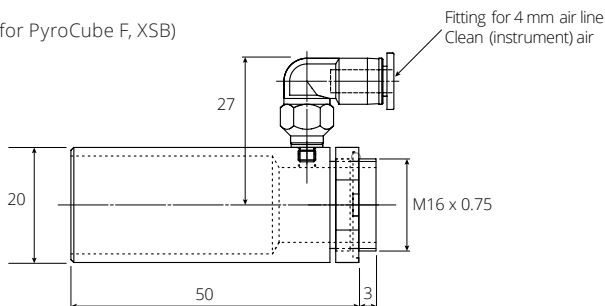



Airless Dust Protector

Helps stop dust from reaching the lens.
No air supply required.
For use in dry atmospheres only.

ADP (for PyroCube S, G, P, MB models)

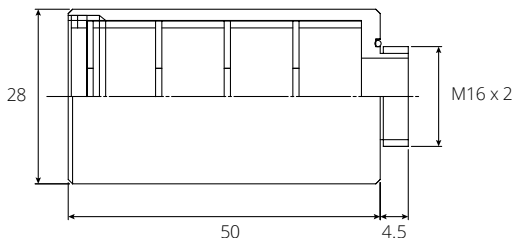

ADPF (for PyroCube F, XSB models)

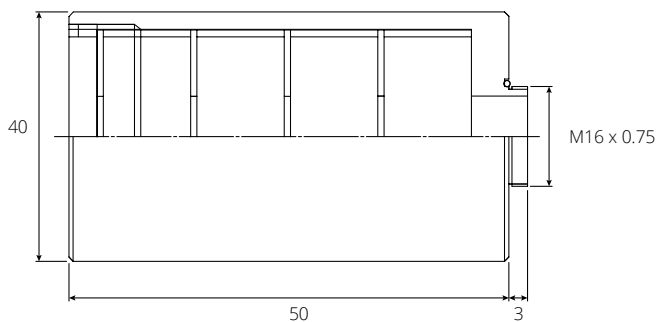

Extension Cable

Supplied with connectors at both ends for easy attachment to the sensor cable. Length: 5 metres.

Other lengths available – contact Caalex for details.



Protective Window

Replaceable IR-transmissive window to help protect the lens from dirt and damage in harsh applications.

PWC (for PyroCube S, G, P, MB models)

PWCF (for PyroCube F, XSB models)

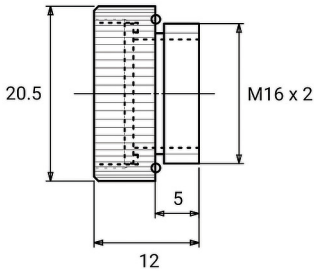

M16 x 2

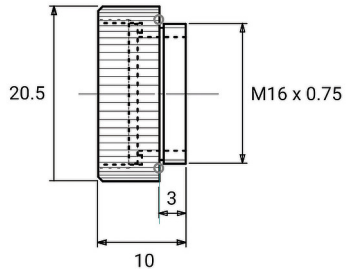

M16 x 0.75



MicroSD Card and Adapter

Stores logged data. SD Card Adapter allows data transfer to a PC.



Right Angled Mirror

Angles the sensor's field of view by 90°.

A protective window is included to help keep the mirror and lens clean.

RAM (for PyroCube S, G, P, MB models)
and RAMF (for PyroCube F, XSB models)

A: M16 x 2 (RAM)
M16 x 0.75 (RAMF)

B: 5 (RAM)
3 (RAMF)

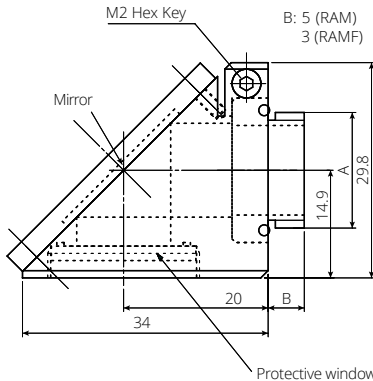
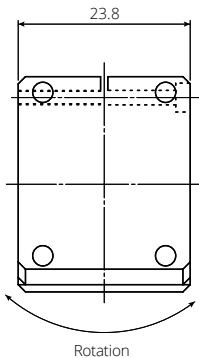

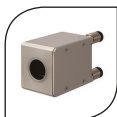

Water Cooled Jacket

In areas of high ambient temperature, use the water cooled jacket to keep the sensor body temperature within 0 to 50°C. The water cooling jacket may be fitted to an existing sensor.

Cooling water flow rate should be approximately 0.6 l/min.

The integrated air purge must be used to stop condensation forming on the lens while the sensor is being cooled.

Note: The sensor output cable is rated to 80°C ambient temperature.

INSTALLATION

The installation process consists of the following stages:

Preparation

Mechanical installation

Electrical installation

Please read the following sections thoroughly before proceeding with the installation.

PREPARATION

Distance and Spot Size

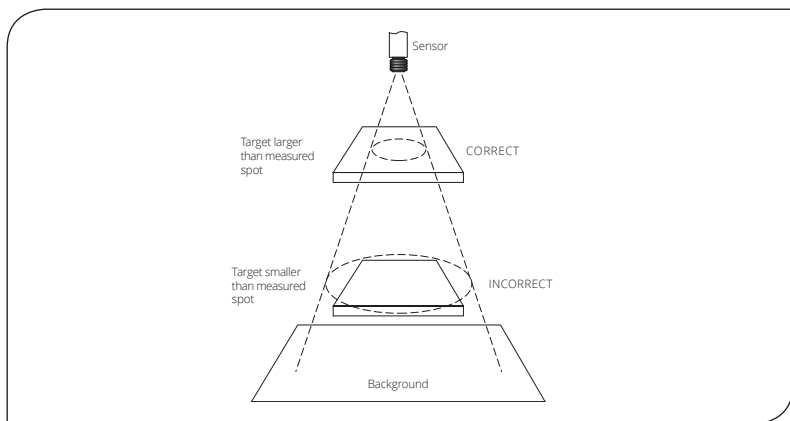

The size of the area (spot size) to be measured determines the distance between the sensor and the target. The spot size must not be larger than the target. Choose a suitable mounting distance so that the measured spot size is smaller than the target.

Reflections

The sensor must be installed in a location where energy from tungsten lamps, heaters and sunlight cannot be reflected from the target into the lens. This is especially important for low- temperature targets. Using fluorescent or mercury lamps, or using shields, may help in this respect. For further information and assistance, contact Calnex.

Ambient Temperature

The sensing head may be used between 0°C and 50°C ambient temperature. If the ambient temperature is higher than this, consider adding a water cooled jacket.

Avoid thermal shock. Allow 20 minutes for the unit to adjust to large changes in ambient temperature.

Atmospheric Quality

Smoke, fumes, dust or steam can contaminate the lens and cause errors in temperature measurement. Carbon dioxide can also influence the reading.

In these types of environment, the amount of contaminant should be minimised, and the air purge collar should be used to help keep the lens clean.

Electrical Interference

The PyroCube is tested to industrial standards for electromagnetic compatibility (EMC). To minimise electromagnetic interference or 'noise', the sensor should be mounted away from motors, generators and such like.

Power Supply

The required supply voltage for the sensor alone (without the PM030 touch screen terminal) is 5 to 27 V DC. The supply voltage for the PM030 is 24 V DC \pm 5%. When using the sensor on its own, the minimum supply voltage depends on the output. Ensure the power supply is of the correct voltage and is capable of providing an output current of at least 100 mA.

MECHANICAL INSTALLATION

All sensors come with a 2 m, 5 m or 10 m cable as standard (see Model Numbers). The cable may be lengthened using the Extension Cable accessory.

Affix the sensor to its mounting. The sensor can be mounted on brackets of your own design, or you can use the mounting bracket accessory.

Switch on the LED sighting to illuminate the measured spot, and adjust the angle of the sensor to aim it.

Ensure the target is larger than the illuminated spot. If not, adjust the measurement distance for a smaller spot size.

Note: The sensor housing must be connected to earth at one point, either the housing of the sensing head, the electronics module, or the output cable shield termination. To avoid ground loops, please ensure the sensor is grounded at only one of these points.

ELECTRICAL INSTALLATION

PyroCube (without PM030 touch screen module)

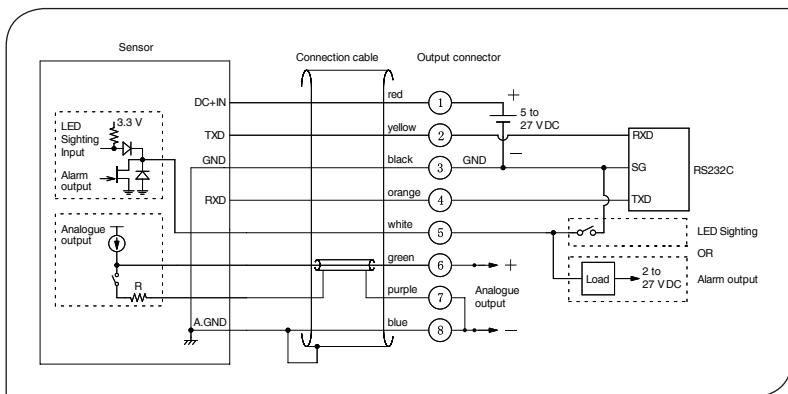

Power Supply: Connect the power supply (5 to 27 V DC) to wires 1 (red, +) and 3 (black, Ground)

Analogue Output: The analogue output can be selected using the PM030 touch screen, or via RS232 Modbus. By default, the output is set to 4-20 mA on all models. Short the inner shield wire 7 (purple) to the ground wire 8 (blue) at the terminal. The analogue output is between wires 6 (green) and 8 (blue).

The minimum sensor power supply voltage depends on the output type being used. Select the output type via RS232C from the following options:

Selected Output Type	Minimum supply voltage	Minimum Output	Output Accuracy
No Analogue Output	5 V	-	-
4 to 20 mA (default setting)	Depending on loop impedance: $2\text{ V} + (0.02\text{ A} \times \text{loop impedance } [\Omega])$.	4.0 mA	$\pm 0.02\text{ mA}$
0 to 20 mA	Depending on loop impedance: $2\text{ V} + (0.02\text{ A} \times \text{loop impedance } [\Omega])$.	0.2 mA	$\pm 0.02\text{ mA}$
0 to 1 V*	5 V	30 mV	$\pm 1.5\text{ mV}$
0 to 5 V*	8 V	30 mV	$\pm 1.5\text{ mV}$
0 to 10 V*	13 V	30 mV	$\pm 1.5\text{ mV}$
mV / °C	5 V	30 mV (= 30°C)	$\pm 1.5\text{ mV}$

*One type of voltage output can be selected, depending on the model.

RS232C Output: Connect the RS232 device to wires 2 (yellow, Receive Data), 3 (black, Signal Ground) and 4 (orange, Transmit Data). The signal ground is common with the 0 V rail of the power supply.

LED Sighting or Alarm Output: Wire 5 (white) can be used either as an alarm output, or as a physical switch for the LED sighting.

By default, the function of this wire is set to Alarm Output, and the LED sighting is set to be continuously on.

The function of this wire, the alarm settings, and the on/off state of the LED sighting are all configurable via RS232C Modbus.

For LED sighting: Connect a switch between wires 5 (white) and 3 (black, Ground).

Note: If wire 5 is shorted with ground then the LED light will turn on, regardless of the LED sighting switch setting.

For Alarm Output: Connect the input of the alarm monitoring device to wire 5 (white). Connect the 0 V (-) terminal of the alarm monitoring device's power supply to wire 3 (black, Ground).

PM030 TOUCH SCREEN MODULE

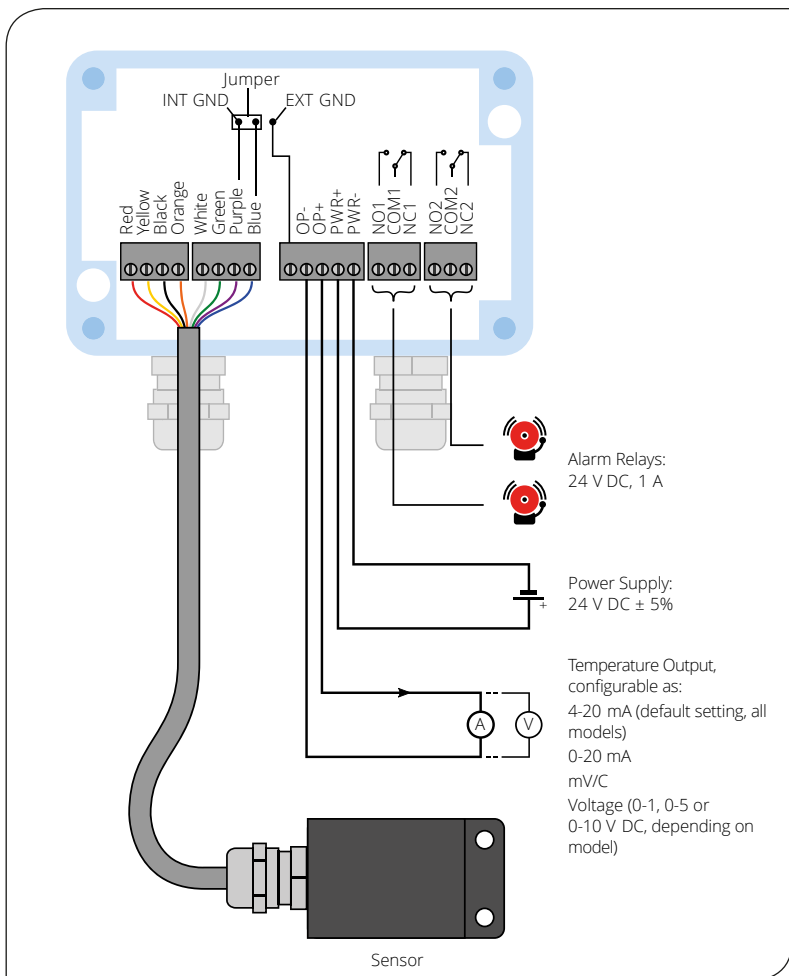

WIRING

The cable is fitted with a male 8-pin Omron e-CON easy-wire connector, and the mating female connector is also supplied. The connectors make it easy to extend the cable and to swap sensors.

You may attach the female connector to your own cable installation, or remove the connectors and wire the sensor into your own terminals directly.

Fitting the Connector

Preparing the Cable

Align the cable with the guide marked STRIP GAUGE on the side of the Connector, strip 7 to 8 mm of the cable sheath, and then twist the wires several times.

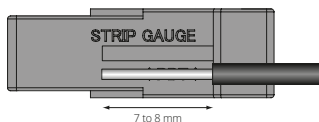

Connecting the Cable to the Connector

- 1 Use a flat-blade screwdriver to push down the operating lever inside the operation slot until it locks.
- 2 Insert the wire fully to the end of the hole. Make sure that the cable sheath is inserted into the hole, and that the end of the wire has passed through the contact section.
- 3 Insert the screwdriver into the release slot, and gently pull back the lever until a click is heard by resetting the lever.

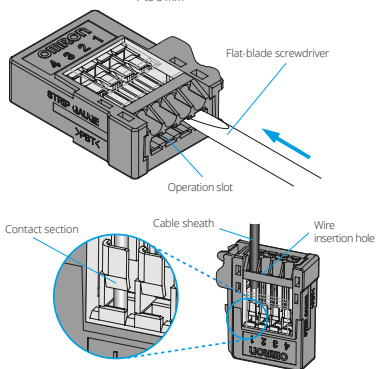

Now perform these checks:

- 1 Check that the operating lever is reset.
- 2 Check that the procedure in step 2 has been followed. (Pull gently on the cable to make sure that there is resistance, indicating that the connectors are wired correctly.)

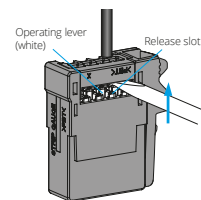

Removing the Connector

- 3 Insert a small flat-bladed screwdriver into the operation slot and press down on the operating lever until it locks.
- 4 Pull the cable out of the connector.
- 5 Reset the operating lever by inserting the screwdriver into the release slot and gently pulling back the lever until it clicks.

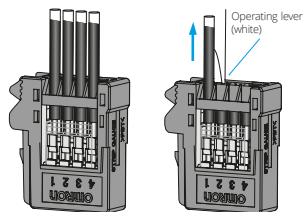

MODBUS OVER SERIAL LINE (RS232C)

Interface

Baud rate	4800, 9600, 19200, 38400, 57600, 115200 (default 9600)
Data Length	8 bits
Parity	None, Odd, Even (default None)
Stop bits	1, 2 (default 2)

Supported Functions

Read register	0x03
Write single register	0x06

The following list includes all available addresses: **R** = Read **W** = Write

Address	Description	R/W
0x0040	Thermometer firmware version	R
0x0100	Measured Temperature - Unfiltered	R
0x0101	Status bits 0..3 : Out of Range Indication 0 = Temperature within limits 1 = Temperature > Maximum 2 = Temperature < Minimum bits 4..7 : Alarm State 0 = No Alarm 1 = Alarm triggered bits 8..11 : Sample Hold State 0 = No sample hold 1 = Holding sample bits 12..15 : Peak Hold State 0 = No peak hold 1 = Hold value indicated 2 = Hold value on analogue output 3 = Hold value indicated and on analogue output	R
0x0102	Measured Temperature - Hold Value	R
0x0103	Emissivity Setting 50 (0.050) ~ 1000 (1.000)	R
0x0120	Alarm High Setpoint	R/W
0x0121	Alarm Low Setpoint	R/W
0x0122	Peak Hold ON/OFF 0 = OFF 1 = ON	R/W
0x0123	Sample Hold ON/OFF 0 = OFF 1 = ON	R/W
0x0124	Smoothing Time 0 = 0.0001 seconds 1 = 0.0002 seconds 2 = 0.0005 seconds 3 = 0.0010 seconds 4 = 0.0020 seconds 5 = 0.0050 seconds 6 = 0.0100 seconds 7 = 0.0200 seconds 8 = 0.0500 seconds 9 = 0.1000 seconds 10 = 0.2000 seconds 11 = 0.5000 seconds 12 = 1.0000 seconds 13 = 2.0000 seconds 14 = 5.0000 seconds	R/W
0x0125	LED Sight Lamp ON/OFF 0 = OFF 1 = ON	R/W

0x0201	External Pin Function 0 = Alarm 1 = External Sight Lamp Control	R/W
0x0202	Sight Lamp Control 0 = Fixed OFF 1 = ON / OFF 2 = Fixed ON	R/W
0x0208	Ambient Reflection ON/OFF 0 = OFF 1 = ON	R/W
0x0209	Alarm Hysteresis range 0 (0.0) ~ 999 (99.9)	R/W
0x020A	Alarm Mode 0 = High ON 1 = High OFF 2 = Low ON 3 = Low OFF 4 = Range ON 5 = Range OFF 6 = Error ON 7 = Error OFF	R/W
0x020C	Alarm Temperature 0 = Measured Temperature - Unfiltered 1 = Measured Temperature - Hold Value	R/W
0x020D	Peak Hold Reset Type 0 = Time 1 = External 2 = Discharge	R/W
0x020E	Peak Hold Reset Time / Discharge Time 1 (0.01 seconds) ~ 1000 (10.00 seconds)	R/W
0x020F	Peak Hold Discharge Level 20 (0.20) ~ 100 (1.00)	R/W
0x0210	Peak Hold Output 0 = Indication Only 1 = Indication & Analogue Output 2 = Indication & Analogue Output 3 = Analogue Output Only	R/W
0x0211	Peak Hold - Polarity of External Reset Signal 0 = Positive 1 = Negative	R/W
0x0212	Sample Hold Output 0 = Indication Only 1 = Indication & Analogue Output 2 = Indication & Analogue Output 3 = Analogue Output Only	R/W
0x0213	Sample Hold - Polarity of External Reset Signal 0 = Positive 1 = Negative	R/W

0x0214	Analogue Output Type 0 = 4 ~ 20mA 1 = 0 ~ 20mA 2 = 0 ~ 1V 3 = mV / °C 4 = No Output	R/W
0x0215	Analogue Output Upper Limit	R/W
0x0216	Analogue Output Lower Limit	R/W
0x0217	Analogue Output Polarity On Error 0 = Untreated 1 = High 2 = Low	R/W
0x021B	Sensor Correction Span 500 (0.500) ~ 2000 (2.000)	R/W
0x021C	Sensor Correction Offset -500 (-50.0) ~ 500 (50.0)	R/W
0x021E	Communication Speed 0 = 1200 bps 1 = 2400 bps 2 = 4800 bps 3 = 9600 bps 4 = 19200 bps 5 = 38400 bps 6 = 57600 bps 7 = 115200 bps	R/W
0x021F	Parity Bit 0 = None 1 = Even 2 = Odd	R/W
0x0220	Stop Bits 0 = 1 stop bit 1 = 2 stop bits	R/W
0x0300	Emissivity Setting (written to permanent memory) 50 (0.050) ~ 1000 (1.000)	R/W
0x0301	Emissivity Setting (not written to permanent memory) 50 (0.050) ~ 1000 (1.000)	R/W
0x0302	Teach Emissivity (write known temperature to calculate correct Emissivity setting)	W
0x0303	Reflected Energy Value (written to permanent memory) -1999 ~ 9999	R/W
0x0304	Reflected Energy Value (not written to permanent memory) -1999 ~ 9999	R/W
0x0305	Teach Reflected Energy Value (write known temperature to calculate correct Reflected Energy Value setting)	W
0x0306	Reset to default values (write 1)	W

OPERATION

Once the sensor is in position and the appropriate power, air and cable connections are secure, the system is ready for continuous operation by completing the following simple steps:

1. Turn on the sensor power supply
2. Turn on the connected instrumentation
3. Read, monitor or log the temperature

IMPORTANT

Be aware of the following when using the sensor:

If the sensor is exposed to significant changes in ambient temperature (hot to cold, or cold to hot), allow 20 minutes for the temperature to stabilise before taking or recording measurements.

When power is switched on, allow the sensor to warm up for 1 minute before taking or recording measurements.

Do not operate the sensor near large electromagnetic fields (e.g. around arc welders or induction heaters). Electromagnetic interference can cause measurement errors.

Wires must be connected only to the appropriate terminals.

Do not open the sensor housing. This will damage the sensor and invalidate the warranty.

VIEWING THROUGH A WINDOW

The sensor is capable of measuring the temperature of a target through a window made of a suitable infrared-transmissive material. The emissivity setting of the sensor should be adjusted to compensate for the presence of the window. Please contact Calnex for more information on using the sensor with a window.

MAINTENANCE

Our customer service representatives are available for application assistance, calibration, repair, and solutions to specific problems. Contact our Service Department before returning any equipment.

In many cases, problems can be solved over the telephone. If the sensor is not performing as it should, try to match the symptom below to the problem. If the table does not help, call Calnex for further advice.

LENS CLEANING

The lens must be kept clean and dry for maximum accuracy. Check the condition of the lens regularly.

If the lens has become dirty, the measurement accuracy will be affected. Blow off loose particles (if not using the air purge accessory) with an air "puffer".

TROUBLESHOOTING

Symptom	Probable Cause	Solution
No output	No power to sensor	Check power supply and wiring
Inaccurate measured temperature	Target too small for sensor's field of view	Ensure the sensor's view is completely filled by the target. Position the sensor closer to the target to measure a smaller area.
	Field of view obstruction	Remove obstruction; ensure sensor has a clear view of target
	Dust or condensation on lens	Ensure lens is clean and dry. Clean gently with a soft lens cloth and water. If problem recurs, consider using an air purge collar.
	Incorrect wire connections	Check wire colour codes
Erroneous temperature (analogue output)	Output temperature scale mismatch	Re-scale input temperature range on measurement instrument to match sensor

PASSWORD

The default password is 1234. The password may be changed via the interface.

GUARANTEE

Calex guarantees each instrument it manufactures to be free from defect in material and workmanship under normal use and service for the period of one year from the date of purchase. This guarantee extends only to the original buyer according to Calex Terms and

Issue 1 - Jun 21
