



Indoor Ambiance Monitoring Sensor

Featuring LoRaWAN[®]

AM300(L) Series

User Guide



Applicability

This guide is applicable to AM300(L) series sensors shown as follows, except where otherwise indicated.

Model	Description
AM307(L)	Indoor Ambiance Sensor (Temp, Hum, Light, Motion, CO ₂ , TVOC, Pressure)
AM308(L)	Indoor Ambiance Sensor (Temp, Hum, Light, Motion, CO ₂ , TVOC, Pressure, PM2.5, PM10)
AM319(L)	Indoor Ambiance Sensor (Temp, Hum, Light, Motion, CO ₂ , TVOC, Pressure, PM2.5, PM10, HCHO/O ₃)

Safety Precautions

Milesight will not shoulder responsibility for any loss or damage resulting from not following the instructions of this operating guide.

- ❖ The device must not be disassembled or remodeled in any way.
- ❖ In order to protect the security of the device, please change device password when first configuration. The default password is 123456.
- ❖ Do not place the device outdoors where the temperature is below/above operating range. Do not place the device close to objects with naked flames, heat source (oven or sunlight), cold source, liquid and extreme temperature changes.
- ❖ The device is not intended to be used as a reference sensor, and Milesight will not should responsibility for any damage which may result from inaccurate readings.
- ❖ The battery should be removed from the device if it is not to be used for an extended period. Otherwise, the battery might leak and damage the device. Never leave a discharged battery in the battery compartment.
- ❖ The device must never be subjected to shocks or impacts.
- ❖ Do not clean the device with detergents or solvents such as benzene or alcohol. To clean the device, wipe with a soft moistened cloth. Use another soft, dry cloth to wipe dry.

Declaration of Conformity

AM300(L) series is in conformity with the essential requirements and other relevant provisions of the CE, FCC, and RoHS.

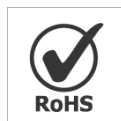

All information in this guide is protected by copyright law. Whereby, no organization or individual shall copy or reproduce the whole or part of this user guide by any means without written authorization from Xiamen Milesight IoT Co., Ltd.

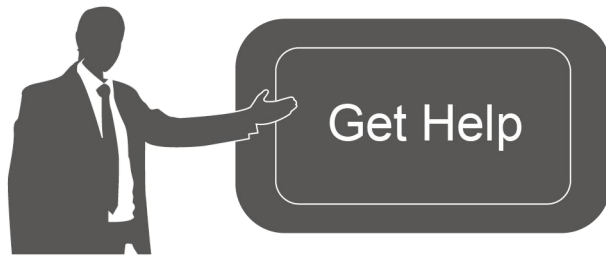

For assistance, please contact

Milesight technical support:

Email: iot.support@milesight.com

Tel: 86-592-5085280

Fax: 86-592-5023065

Address: Building C09, Software Park III,
Xiamen 361024, China

Revision History

Date	Doc Version	Description
Oct.9, 2021	V 1.0	Initial version
Aug. 18, 2022	V1.1	<ol style="list-style-type: none"> 1. Add button lock feature 2. Add downlink commands 3. Add illuminance levels and guidelines
Aug. 22, 2022	V2.0	<ol style="list-style-type: none"> 1. Update TVOC contents based on hardware 2.x 2. Add AM308 model 3. Support data retransmission feature 4. Support downlink commands to ask for historical data
Aug. 31, 2023	V2.1	<ol style="list-style-type: none"> 1. Update mounting bracket picture, delete 86 box mounting 2. Add single channel mode 3. Add AM300L Series

Contents

1. Product Introduction	5
1.1 Overview	5
1.2 Features	5
2. Hardware Introduction	5
2.1 Packing List	5
2.2 Hardware Overview	6
2.3 E-ink Screen (AM300 Series Only)	7
2.3.1 Screen Description	7
2.3.2 Screen Mode Switch	8
2.4 Button and Traffic Light	8
2.5 Dimensions	9
3. Power Supply	9
4. Operation Guide	10
4.1 Log in the ToolBox	10
4.1.1 NFC Configuration	10
4.1.2 USB Configuration	10
4.2 LoRaWAN Settings	11
4.3 Time Synchronization	14
4.4 Basic Settings	15
4.5 Advanced Settings	17
4.5.1 Data Collection Settings	17
4.5.2 Calibration Settings	17
4.5.3 Threshold Settings	18
4.5.4 Data Storage	19
4.5.5 Data Retransmission	20
4.6 Maintenance	21
4.6.1 Upgrade	21
4.6.2 Backup	22
4.6.3 Reset to Factory Default	23
5. Installation	24
6. Device Payload	25
6.1 Basic Information	25
6.2 Sensor Data	26
6.3 Downlink Commands	29
6.4 Historical Data Enquiry	30
Appendix	32
Carbon Dioxide Levels and Guidelines	32
TVOC Levels and Guidelines	32
Illuminance Levels and Guidelines	32

1. Product Introduction

1.1 Overview

AM300(L) series is a compact indoor ambience monitoring sensor including motion, humidity, temperature, light, TVOC, CO₂, HCHO/O₃ level, barometric pressure and PM2.5 & PM10 for wireless LoRa network. It is equipped with NFC (Near Field Communication) and can easily be configured via a smartphone or a PC software.

Sensor data are transmitted in real-time using standard LoRaWAN[®] protocol. LoRaWAN[®] enables encrypted radio transmissions over long distance while consuming very little power. The user can obtain sensor data and view the trend of data change through Milesight IoT Cloud or through the user's own Network Server.

1.2 Features

- Robust LoRaWAN[®] connectivity for indoor or HVAC environments
- Integrated multiple sensors like temperature, humidity, light, air quality, etc.
- Easy configuration via NFC
- Multiple display mode and clear emoticon on the e-ink screen
- Equipped with traffic light and buzzer to indicate threshold
- Milesight IoT Cloud compliant
- Battery or DC power supply

2. Hardware Introduction

2.1 Packing List



1 × AM300(L)
Series Device

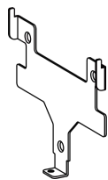

1 × Mounting
Bracket



1 × 3M
Double-Sided
Tape

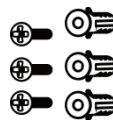

3 × Wall
Mounting Kits



1 × Theft-Detering
Screw

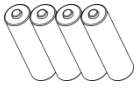

4 x

ER14505 Li-SOCl₂
Batteries
(AM30x(L) Only)

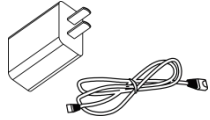

1 x

Type-C Cable (1.2 m)
& Power Adapter
(AM319(L) Only)



1 x

Quick Guide



1 x

Warranty Card





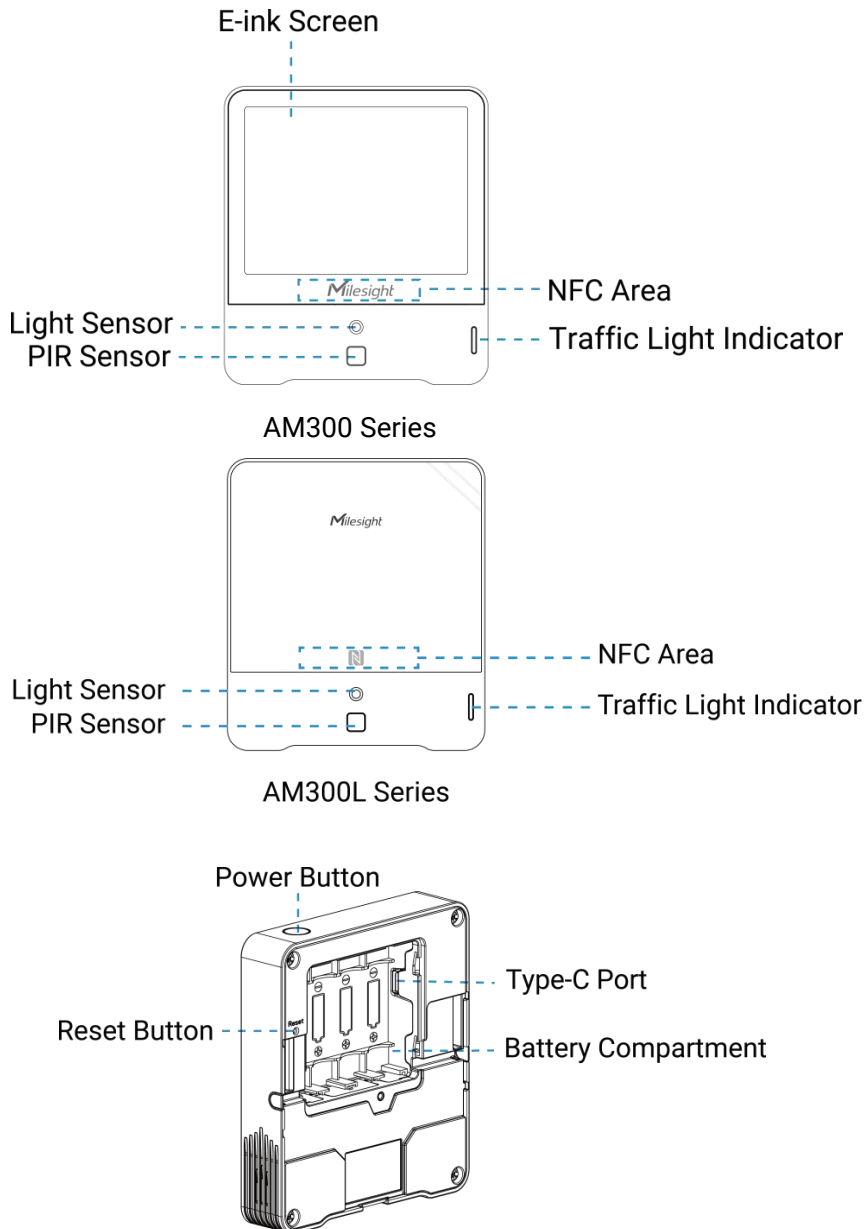







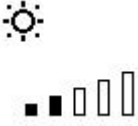

⚠ If any of the above items is missing or damaged, please contact your sales Representative.

2.2 Hardware Overview

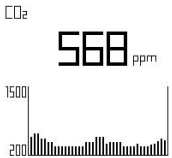

2.3 E-ink Screen (AM300 Series Only)

2.3.1 Screen Description

Icon	Description
	Battery level (AM30x Only)
	Battery is exhausted (AM30x Only).
01/01/2021 07:02	Sync time with software or mobile App.
	The device joins the network.
	The device fails to join the network.
	Temperature
	Humidity
	Level 0: 0-5 lux Level 1: 6-50 lux Level 2: 51-100 lux Level 3: 101-500 lux Level 4: 501-2000 lux Level 5: > 2000 lux
	Level 0: ≤1.99 Level 1: 2.00-2.50 Level 2: 2.51-2.99 Level 3: 3.00-3.99 Level 4: 4.00-4.99 Level 5: ≥5.00
	Show CO ₂ levels history tendency from 200 to 1500 ppm
	CO ₂ /TVOC/PM2.5/PM10/HCHO/O ₃ exceeds the Polluted threshold
	CO ₂ /TVOC/PM2.5/PM10/HCHO/O ₃ exceeds the Bad threshold
	Excellent Environment
	When one of the concentrations of air pollutants of CO ₂ , TVOC, PM2.5, PM10, HCHO/O ₃ exceeds the Polluted threshold
	When one of the concentrations of air pollutants of CO ₂ , TVOC, PM2.5, PM10, HCHO/O ₃ exceeds the Bad threshold

Note:

- AM300 series will update screen data every 1 minute and do a full-screen refresh every 30 minutes (AM319) or 60 minutes (AM307 and AM308) in order to remove ghosting.
- When AM300 series detects the temperature beyond the range from 0°C to 40°C, the screen will close automatically.
- Please refer [section 4.5.3](#) for Excellent/Polluted/Bad threshold settings.

2.3.2 Screen Mode Switch

Here are 3 methods to switch between the three modes:

- Power button: When button lock is disabled, quick press the power button to switch the mode.
- Mobile App: Go to Milesight ToolBox App menu **Device > Setting > General Settings** to select screen display mode.
- Software: Go to **Device Settings > Basic > Basic Settings** to select screen display mode.

2.4 Button and Traffic Light

Function	Action	Light Status
Power ON/OFF	Press and hold the power button for more than 3 seconds.	Power On: Off → On Power Off: On → Off
Switch Screen Display Mode	Quick press the power button once.	Blinks once
Reset to Factory Default	Press and hold the reset button for more than 10 seconds.	Quickly Blinks
Air Quality Level Indication	Indicate the 3 levels of air quality according to threshold setting. When one of the concentrations of air pollutants of CO ₂ , TVOC, PM2.5, PM10 or HCHO/O ₃ exceeds the threshold, the light color will change to orange or red	Excellent: Blinks/Always On (Configurable) Polluted: Blinks/Always On (Configurable) Bad: Blinks/Always On (Configurable)

Note:

- If the traffic light is disabled, it will not show air quality level indication.
- AM319(L) supports Traffic Light as Blinking or Always On to indicate Polluted or Bad indoor ambience, while AM307(L) and AM308(L) only support Blinking mode.

2.5 Dimensions(mm)

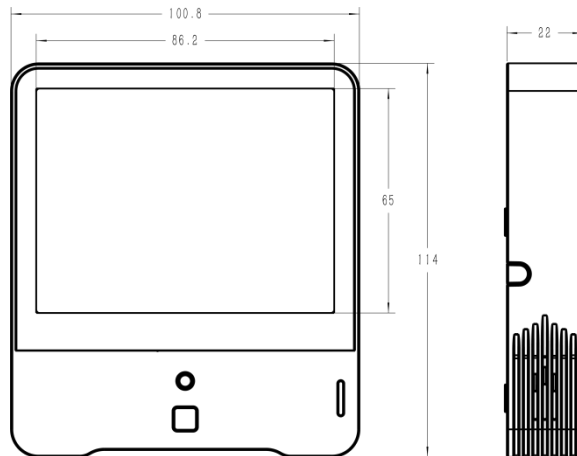

3. Power Supply

1. Release the screw at the back of device and remove the rear cover.
2. Install the batteries or type-C cable to the device. If the device is powered via type-C port, then left or right side should make an opening to pass through the type-C cable.

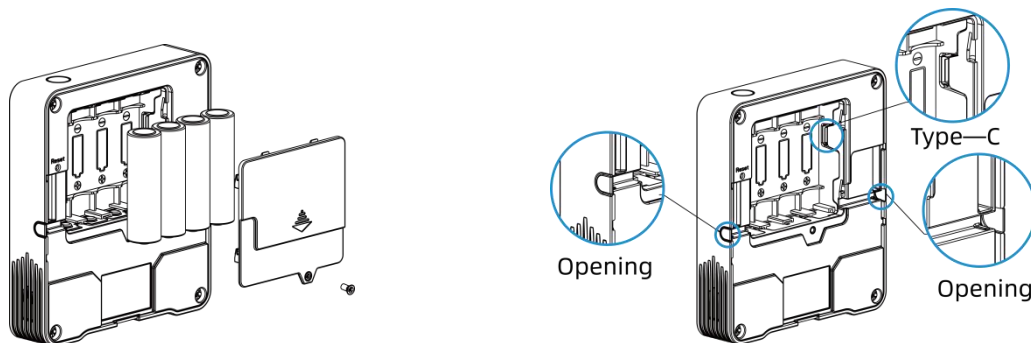

3. Fix the rear cover back to device with the fixing screw.

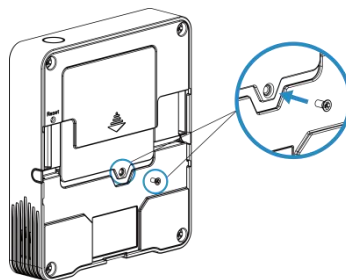

Note:

- AM307(L) and AM308(L) can be powered via USB type-C port or by ER14505 Li-SOCl₂ batteries. When batteries and external power are both used, external power will be the preferred power supply option.
- AM319(L) supports powered via USB type-C port only.
- Type-C port can't be used to charge battery.
- Make sure all batteries are newest when install, or battery life will be reduced.

4. Operation Guide

4.1 Log in the ToolBox

AM300(L) series can be monitored and configured via ToolBox App or ToolBox software. Please select one of them to complete configuration.

4.1.1 NFC Configuration

1. Download and install Milesight ToolBox App from Google Play or Apple App Store.
2. Enable NFC on the smartphone and launch Milesight ToolBox.
3. Attach the smartphone with NFC area to the device, click **NFC Read** to read device information. Basic information and settings of the device will be shown on ToolBox App if it's recognized successfully. You can read and configure the device by tapping the Read/Write device on the App. In order to protect the security of the device, please change password when first configuration. The default password is **123456**.

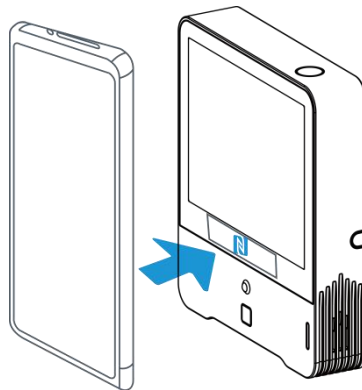

Note:

- 1) Ensure the location of smartphone NFC area and it's recommended to take off phone case.
- 2) If the smartphone fails to read/write configurations via NFC, keep the phone away and back to try again.
- 3) AM300(L) series can also be configured by dedicated NFC reader, which can be purchased from Milesight IoT.

4.1.2 USB Configuration

1. Download ToolBox software from Milesight official website.
2. Connect the device to a computer via Type-C port.

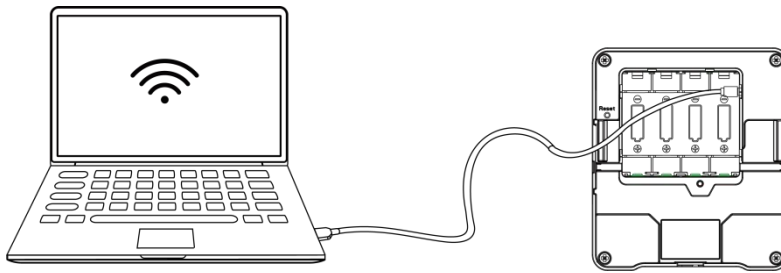

3. Open the ToolBox and select type as **General**, then click password to log in ToolBox. (Default password: **123456**)

The screenshot shows a dialog box titled "ToolBox Settings" with a close button (X) in the top right corner. The dialog contains the following fields:

- Type: General (dropdown menu)
- Serial port: COM4 (dropdown menu)
- Login password: (text input field)
- Baud rate: 115200 (dropdown menu)
- Data bits: 8 (dropdown menu)
- Parity bits: None (dropdown menu)
- Stop bits: 1 (dropdown menu)

At the bottom of the dialog are two buttons: "Save" and "Cancel".

4. After logging in the ToolBox, users can turn on/off device and change other settings.

Status >

Power Off

Model:	AM319-470M
Serial Number:	6710B32112801913
PN:	HCHO
Device EUI:	24e124710b321128
Firmware Version:	01.01
Hardware Version:	1.0
Device Status:	On
Join Status:	Activate
RSSI/SNR:	-101/4
Temperature:	27.0°C
Humidity:	59.00%

4.2 LoRaWAN Settings

LoRaWAN settings is used for configuring the transmission parameters in LoRaWAN® network.

Basic LoRaWAN Settings:

Configure join type, App EUI, App Key and other information. You can also keep all settings by default.

Device EUI	<input type="text" value="24E124445D112669"/>
App EUI	<input type="text" value="24E124C0002A0001"/>
Application Port	<input type="text" value="85"/>
Join Type	<input type="text" value="OTAA"/>
LoRaWAN Version	<input type="text" value="V1.0.2"/>
Class Type	<input type="text" value="Class C"/>
Application Key	<input type="text" value="*****"/>
RX2 Data Rate	<input type="text" value="DR0 (SF12, 125 kHz)"/>
RX2 Frequency	<input type="text" value="505300000"/>
Spread Factor	<input type="text" value="SF12-DR0"/>
Confirmed Mode	<input type="checkbox"/>
Rejoin Mode	<input checked="" type="checkbox"/>
Set the number of packets sent	<input type="text" value="32"/> packets
TXPower	<input type="text" value="TXPower0-19.15 dBm"/>

Parameters	Description
Device EUI	Unique ID of the device which can also be found on the label.
App EUI	Default App EUI is 24E124C0002A0001.
Application Port	The port is used for sending and receiving data, default port is 85.
Join Type	OTAA and ABP mode are available.
LoRaWAN Version	V1.0.2, V1.0.3 are available.
Application Key	Appkey for OTAA mode, default is 5572404C696E6B4C6F52613230313823.
Device Address	DevAddr for ABP mode, default is the 5 th to 12 th digits of SN.
Network Session Key	Nwkskey for ABP mode, default is 5572404C696E6B4C6F52613230313823.
Application Session Key	Appskey for ABP mode, default is 5572404C696E6B4C6F52613230313823.
Spread Factor	If ADR is disabled, the device will send data via this spread factor.
Confirmed Mode	If the device does not receive ACK packet from network server, it will resend data once.
Rejoin Mode	Reporting interval \leq 35 mins: the device will send a specific number of LinkCheckReq MAC packets to the network server every reporting interval or every double reporting interval to validate connectivity; If there is no response,

	<p>the device will re-join the network.</p> <p>Reporting interval > 35 mins: the device will send a specific number of LinkCheckReq MAC packets to the network server every reporting interval to validate connectivity; If there is no response, the device will re-join the network.</p>
Set the number of packets sent	<p>When rejoin mode is enabled, set the number of LinkCheckReq packets sent.</p> <p>Note: the actual sending number is Set the number of packet sent + 1.</p>
ADR Mode	Allow network server to adjust datarate of the device.
Tx Power	Transmit power of the device.

Note:

- 1) Please contact sales for device EUI list if there are many units.
- 2) Please contact sales if you need random App keys before purchase.
- 3) Select OTAA mode if you use Milesight IoT cloud to manage devices.
- 4) Only OTAA mode supports rejoin mode.

LoRaWAN Frequency Settings:

Select supported frequency and select channels to send uplinks. Make sure the channels match the LoRaWAN® gateway.

Note: When Single-Channel Mode is enabled, only one channel can be selected to send uplinks and the ADR will not work. Please enable Single-Channel Mode if you connect device to DS7610.

<input type="checkbox"/>	Index	Frequency/MHz	Min Datarate	Max Datarate
<input checked="" type="checkbox"/>	0	868.1	5-SF7BW125	0-SF12BW125
<input checked="" type="checkbox"/>	1	868.3	5-SF7BW125	0-SF12BW125
<input checked="" type="checkbox"/>	2	868.5	5-SF7BW125	0-SF12BW125
<input type="checkbox"/>	3	0	5-SF7BW125	0-SF12BW125
<input type="checkbox"/>	4	0	5-SF7BW125	0-SF12BW125
<input type="checkbox"/>	5	0	5-SF7BW125	0-SF12BW125
<input type="checkbox"/>	6	0	0-SF12BW125	5-SF7BW125
<input type="checkbox"/>	7	0	0-SF12BW125	5-SF7BW125

Save

If frequency is one of CN470/AU915/US915, you can enter the index of the channel that you want to enable in the input box, making them separated by commas.

Examples:

1, 40: Enabling Channel 1 and Channel 40

1-40: Enabling Channel 1 to Channel 40

1-40, 60: Enabling Channel 1 to Channel 40 and Channel 60

All: Enabling all channels

Null: Indicates that all channels are disabled

Supported Frequency :

Single-Channel Mode: Enabled Channel Index:

Channel Index	Frequency/MHz	Channel Spacing/MHz	BW/kHz
0 - 15	902.3 - 905.3	0.2	125
16 - 31	905.5 - 908.5	0.2	125
32 - 47	908.7 - 911.7	0.2	125
48 - 63	911.9 - 914.9	0.2	125
64 - 71	903.0 - 914.2	1.6	500

Note:
64 channels numbered 0 to 63 utilizing LoRa 125 kHz BW starting at 902.3 MHz and incrementing linearly by 0.2 MHz to 914.9
8 channels numbered 64 to 71 utilizing LoRa 500 kHz BW starting at 903.0 MHz and incrementing linearly by 1.6 MHz to 914.2

4.3 Time Synchronization

ToolBox Sync:

Go to **Device > Status** of ToolBox App to click **Sync** to sync the time, or go to **Status** page of ToolBox software to sync the time.

Status | Setting | Reset

Device Status: ON

Join Status: Activated

RSSI/SNR: -44/9

Device Time: 1970-01-24 09:10

Temperature: 27.0 °C

Humidity: 58.5 %

Activity Level (PIR): 1

Illumination: 89 lux

Battery: 61 %

Channel Mask: 0003

Status > | Read | Power Off

Device Status: On

Join Status: De-Activate

RSSI/SNR: 0/0

Temperature: Disabled

Humidity: 61.5%

Activity Level (PIR): 40

Illumination: 85 lux

CO2: 585 ppm

TVOC: 210 ppb

Barometric Pressure: 1006.1 hPa

Battery: 92%

Channel Mask: 000000000000000000000000ff

Uplink Frame-counter: 0

Downlink Frame-counter: 0

Device Time: 2020-08-21 13:18:12

Network Server Sync:

Go to **LoRaWAN Settings > Basic** of ToolBox software or **Device > Settings > LoRaWAN Settings** of ToolBox App to change device LoRaWAN® version as 1.0.3, then the device will send MAC

commands to enquire the time from network server every time it joins the network. This should ensure the network server supports this feature.

4.4 Basic Settings

Go to **Device Settings > Basic** of ToolBox software or **Device > Settings > General Settings** of ToolBox App to change the reporting interval, screen mode, etc.

Reporting Interval(min)	<input type="text" value="10"/>
Temperature Unit	<input type="text" value="°C"/>
LED Indicator	<input checked="" type="checkbox"/>
Buzzer	<input type="checkbox"/>
Button Lock	<input checked="" type="checkbox"/>
On\Off, Display Mode Switch	
Data Storage	<input checked="" type="checkbox"/>
Data Retransmission	<input checked="" type="checkbox"/>
Screen Display	<input checked="" type="checkbox"/>
Smart Screen Mode	<input checked="" type="checkbox"/>
Screen Display Mode	<input type="text" value="Mode1(Display Time,CO2,PM2.5,"/>
Color Theme	<input type="text" value="Light"/>
Change Password	<input type="checkbox"/>

Parameters	Description
Reporting Interval	Reporting interval of transmitting current sensor values and battery level to network server. Default: 10 mins, Range: 1-1080 mins
Temperature Unit	Change the temperature unit displayed on the ToolBox and screen. Note: 1) The temperature unit in the reporting package is fixed as °C. 2) Please modify the threshold settings if the unit is changed.
LED Indicator	Enable or disable the traffic light indicator to indicate air quality level. AM307(L) & AM308(L): Blink AM319(L): Always On, Blink

Buzzer	Enable or disable the buzzer. If enabled, the buzzer will response when one of concentrations of air pollutants exceeds the Bad threshold. It will automatically stop when the concentration values are lower than the Bad threshold.
Check Button	When enabled, users can press the power button to stop the buzzer beep.
Button Lock	When enabled, users can choose to lock the feature of power button: display mode switch or power on/off.
Data Storage	Disable or enable data storage locally. (see section 4.5.4 to export data)
Data Retransmission	Disable or enable data retransmission. (see section 4.5.5)
Change Password	Change the password for ToolBox App or software to read/write this device.
AM300 Series Only	
Screen Display	Disable or enable screen display.
Smart Screen Mode	When PIR value is 0 (Vacant) and last for 20 mins, the screen will stop updating to save power.
Screen Display Mode	Select the screen display contents. AM307 Mode 1: Time&Date, CO ₂ , Temperature, Humidity Mode 2: CO ₂ , Temperature, Humidity, TVOC, light Mode 3: Time&Date, CO ₂ , Temperature, Humidity, TVOC, light AM308 Mode 1: Time&Date, CO ₂ , PM2.5&PM10, Temperature, Humidity Mode 2: CO ₂ , PM2.5&PM10, Temperature, Humidity, TVOC, light Mode 3: Time&Date, CO ₂ , PM2.5&PM10, Temperature, Humidity, TVOC, light AM319 Mode 1: Time&Date, CO ₂ , PM2.5&PM10, Temperature, Humidity Mode 2: CO ₂ , PM2.5&PM10, HCHO/O ₃ , Temperature, Humidity, TVOC, light Mode 3: Time&Date, CO ₂ , PM2.5&PM10, HCHO/O ₃ , Temperature, Humidity, TVOC, light
Color Theme	Select screen display background color as Light or Dark.

4.5 Advanced Settings

4.5.1 Data Collection Settings

Go to **Device Settings > Basic** of ToolBox software or **Device > Settings > Data Collection Settings** of ToolBox App to select the data you need to monitor. Among them, temperature, humidity and CO₂ are not allowed to disable. If any item is disabled, it will disappear from the screen.

Temperature	<input type="checkbox"/>
Humidity	<input type="checkbox"/>
CO2	<input type="checkbox"/>
Activity Level (PIR)	<input checked="" type="checkbox"/>
Illumination	<input checked="" type="checkbox"/>
TVOC	<input checked="" type="checkbox"/>
Barometric Pressure	<input checked="" type="checkbox"/>
PM2.5	<input checked="" type="checkbox"/>
PM10	<input checked="" type="checkbox"/>
HCHO	<input checked="" type="checkbox"/>

4.5.2 Calibration Settings

ToolBox supports numerical calibration for all items. Go to **Device Settings > Basic** of ToolBox software or **Device > Settings > Calibration Settings** of ToolBox App to type the calibration value and save, the device will add the calibration value to raw value.

Temperature Calibration	<input checked="" type="checkbox"/>
Current Value	26 °C
Calibration Value	<input type="text" value="-0.1"/> °C
Final Value	25.9 °C
Humidity Calibration	<input type="checkbox"/>
CO2 Calibration	<input type="checkbox"/>
Barometric Pressure Calibration	<input type="checkbox"/>
PM2.5 Calibration	<input type="checkbox"/>
PM10 Calibration	<input type="checkbox"/>
HCHO Calibration	<input type="checkbox"/>

Besides numerical calibration, ToolBox provides more calibration methods for CO₂:

Manual Calibration: Put the device in an open outdoor environment for more than 10 minutes and click this button to calibrate the CO₂ value.

Restore Factory Calibration: Clean the manual calibration and turn back to factory calibration.

Auto Background Calibration: When enabled, keep the device work in a well-ventilated environment for 180 hours (around 7 days), then disable the calibration.

CO2 Calibration	<input checked="" type="checkbox"/>
<input type="button" value="Manual Calibration"/> ?	
<input type="button" value="Restore Factory Calibration"/> ?	
Auto Background Calibration	<input checked="" type="checkbox"/> ?
Current Value	1524 ppm
Calibration Value	<input type="text" value="0"/> ppm
Final Value	1524 ppm

4.5.3 Threshold Settings

Go to **Device Settings > Basic** of ToolBox software or **Device > Settings > Threshold Settings** of ToolBox App to enable the threshold settings and input the threshold.

For temperature, it will upload the current data once instantly when temperature is over or below the threshold. Note that when you change the temperature unit, please re-configure the threshold.

Temperature / °C	<input checked="" type="checkbox"/>
Over	<input type="text" value="0.0"/>
Below	<input type="text" value="0.0"/>

For CO₂, TVOC, PM_{2.5}, PM₁₀ and HCHO/O₃, it supports defining Excellent, Polluted and Bad threshold for traffic light, buzzer and screen alarms. Besides, when one of concentrations of air pollutants exceeds the Bad threshold, AM300 series will upload the current data once instantly.

Pollutant	Unit	Excellent	Polluted	Bad
CO ₂	ppm	1000	1500	
TVOC		3.00	4.00	
PM _{2.5}	µg/m ³	35	75	
PM ₁₀	µg/m ³	100	150	

4.5.4 Data Storage

AM300(L) series supports storing more than 18000 data records locally and exports data via ToolBox App or ToolBox software. The device will record the data according to reporting interval even not joining network.

1. Ensure the device time is correct (see section [4.3](#));
2. Go to **Device Settings > Basic** of ToolBox software or **Device > Settings > General Settings** of ToolBox App to enable data storage feature.
3. Go to **Maintenance > Basic** of ToolBox software or **Device > Maintenance** of ToolBox App, click **Export**, then select the data time range and click **Save** to export data.

Note: ToolBox App can only export last 14 days' data. If you need to export more data, please use ToolBox software.

4. Click **Clear** to clear all stored data inside the device.

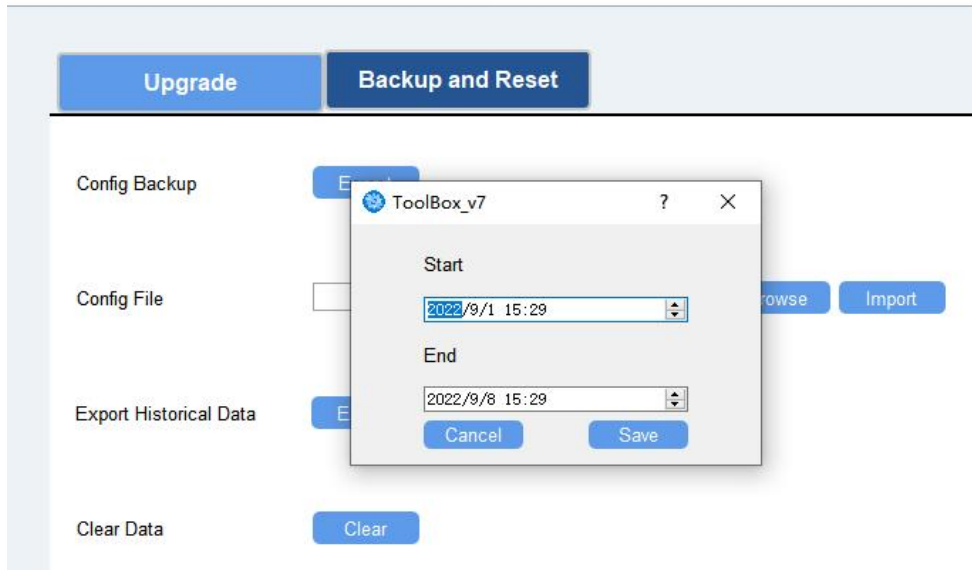
Maintenance >**4.5.5 Data Retransmission**

AM300(L) series sensor supports data retransmission to ensure network server can get all data even if network is down for some times. There are two ways to get the lost data:

- Network server sends downlink commands to enquire the historical data for specifying time range, see section [6.4](#);
- When network is down if no response from LinkCheckReq MAC packets for a period of time, the device will record the network disconnected time and re-transmit the lost data after device re-connects the network.

Here are the steps for data retransmission:

1. Enable data storage feature and data retransmission feature;

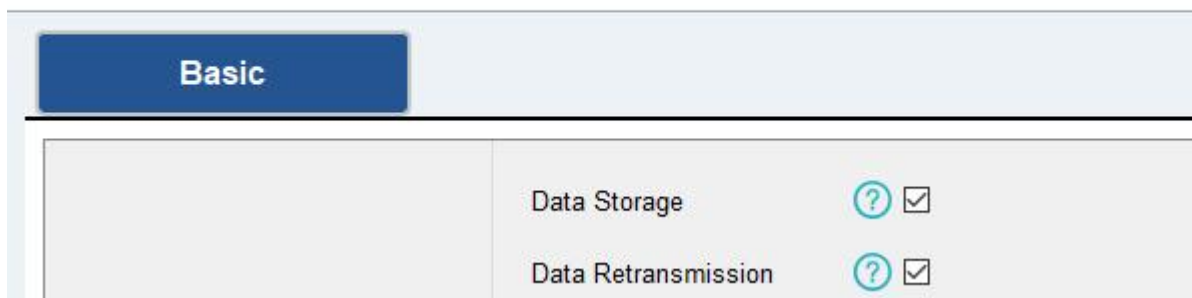
Settings >

2. Enable rejoin mode feature and set the number of packets sent. Take below as example, the device will send LinkCheckReq MAC packets to the network server regularly to check if the network is disconnected; if there is no response for 8+1 times, the join status will change to

de-active and the device will record a data lost time point(the time to join the network).

The screenshot shows a configuration panel with two sections: 'Rejoin Mode' and 'ADR Mode'. Both sections have a question mark icon and a checked checkbox. The 'Rejoin Mode' section includes a text input field labeled 'Set the number of packets sent' with the value '8' and the unit 'packets'.

3. After the network connected back, the device will send the lost data from the point in time when the data was lost according to the reporting interval.

Note:

- 1) If the device is rebooted or re-powered when data retransmission is not completed, the device will re-send all retransmission data again after device is reconnected to the network;
- 2) If the network is disconnected again during data retransmission, it will only send the latest disconnection data;
- 3) The retransmission data format is started with "20ce", please refer to see section [6.4](#).
- 4) Data retransmission will increase the uplinks and shorten the battery life.

4.6 Maintenance

4.6.1 Upgrade

ToolBox Software:

1. Download firmware from Milesight official website to your PC.
2. Go to **Maintenance > Upgrade** of ToolBox software, click **Browse** to import firmware and upgrade the device.

Maintenance >

The screenshot shows the 'Upgrade' tab selected in the 'Maintenance >' section. The interface displays the following information and controls:

- Model:** AM319-470M
- Firmware Version:** 01.01
- Hardware Version:** 1.0
- Domain:** Beijing Server (dropdown menu)
- FOTA:** Up to date (button)
- Update Locally:** (input field) with **Browse** and **Upgrade** buttons.

ToolBox App:

1. Download firmware from Milesight official website to your smartphone.

2. Open ToolBox App and click **Browse** to import firmware and upgrade the device.

Note:

- 1) Operation on ToolBox is not supported during the upgrade.
- 2) Only Android version ToolBox supports the upgrade feature.

SN	6710B32112801913
Model	AM319-470M
Firmware Version	V1.1
Hardware Version	V1.0
Manual Upgrade	

[Browse](#)

4.6.2 Backup

AM300(L) series supports configuration backup for easy and quick device configuration in bulk.

Backup is allowed only for devices with the same model and LoRaWAN® frequency band.

ToolBox Software:

1. Go to **Maintenance > Backup and Reset** of ToolBox software, click **Export** to backup the device configuration.
2. Click **Browse** to import the backup file, then click **Import** to load the configuration.

Maintenance >

Upgrade	Backup and Reset
-------------------------	----------------------------------

Config Backup	Export
Config File	<input type="text"/> Browse Import
Restore Factory Defaults	Reset

ToolBox App:

1. Go to **Template** page on the App and save current settings as a template. You can also edit

the template file.

2. Select one template file that saved in the smartphone and click **Write**, then attach it to another device to write configuration.

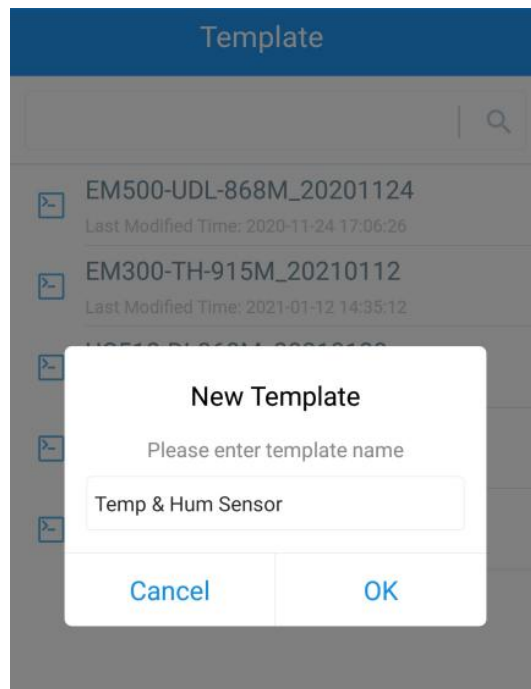

Note: Slide the template item to the left to edit or delete it. Click the template to edit the configurations.

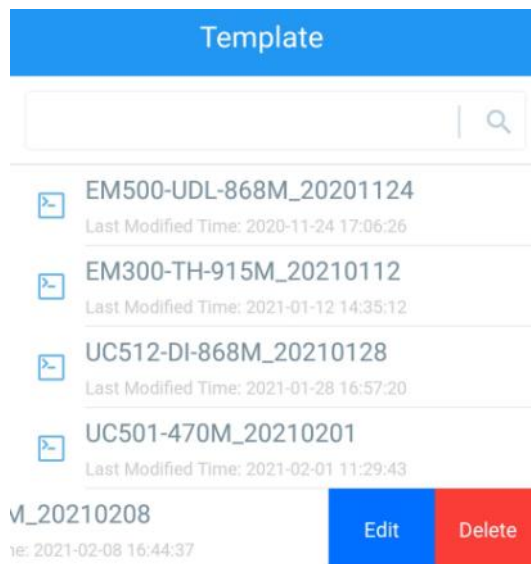

4.6.3 Reset to Factory Default

Please select one of following methods to reset device:

Via Hardware: Hold on reset button more than 10s.

Via ToolBox Software: Go to **Maintenance > Backup and Reset** to click **Reset**.

Via ToolBox App: Go to **Device > Maintenance** to click **Reset**, then attach smart phone with NFC area to device to complete reset.

5. Installation

Fixed by 3M Tape:

1. Paste 3M tape to the back of the mounting bracket, then tear the other side and place it on a flat surface.

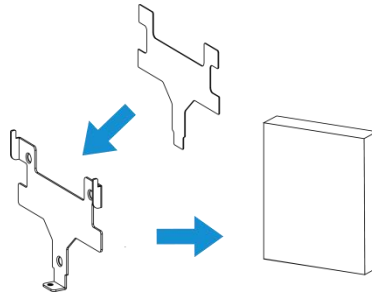

2. Put the device on the mounting bracket, then fix the bottom of the device to the bracket with the theft-detering screw.

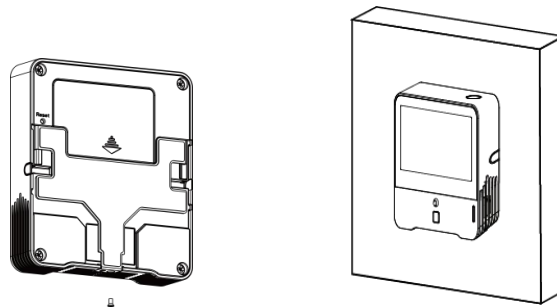

Fixed by Screws:

1. Fix the wall plugs into the wall, then fix the mounting bracket to the wall plugs with screws.

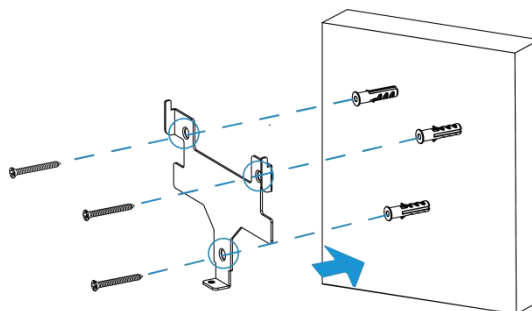

2. Put the device on the mounting bracket, then fix the bottom of the device to the bracket with a fixing screw.

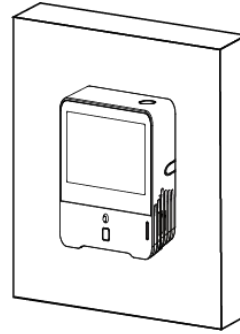
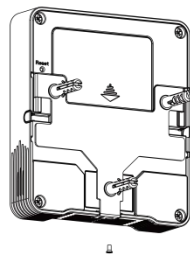
**Note:**

In order to ensure the best detection and LoRaWAN® communication effect, it is recommended to install AM300(L) series as follows:

- There should not be any isolates or barriers in PIR and light detection range.
- Do not mount the device where the temperature is below/above operating range and temperature varies greatly.
- Stay far away from any heat source or cold source like oven, refrigerator.
- Do not mount the device close to where airflow varies greatly like windows, vent, fan and air conditioner.
- Do not mount the device upside down.
- Do not place the device right to the window or door. If you have to, you'd better pull the curtain.
- It is recommended to install at least 1.5 m high from floor.

6. Device Payload

All data are based on following format(HEX), the Data field should follow little-endian:

Channel1	Type1	Data1	Channel2	Type2	Data2	Channel 3	...
1 Byte	1 Byte	N Bytes	1 Byte	1 Byte	M Bytes	1 Byte	...

For decoder examples please find files on <https://github.com/Milesight-IoT/SensorDecoders>.

6.1 Basic Information

AM300(L) series sensors report basic information of sensor whenever joining the network.

Channel	Type	Description
ff	01(Protocol Version)	01=>V1
	09 (Hardware Version)	01 40 => V1.4
	0a (Software Version)	01 14 => V1.14
	0b (Power On)	Device is on
	0f (Device Type)	00: Class A, 01: Class B, 02: Class C
	16 (Device SN)	16 digits
	2e (LED Mode)	00: Off, 01: Always On, 02: Blink
	3e (Buzzer)	00: Off, 01: On

Example:

ff166710b32620711912 ff090200 ff0a0101 ff0f02					
Channel	Type	Value	Channel	Type	Value
ff	16 (Device SN)	6710b32620711912	ff	09 (Hardware version)	0200 (V2.0)
Channel	Type	Value	Channel	Type	Value
ff	0a (Software version)	0101 (V1.1)	ff	0f (Device Type)	02 (Class C)

6.2 Sensor Data

AM300(L) series sensors report sensor data according to reporting interval (10mins by default).

Item	Channel	Type	Description
Battery Level	01	75	UINT8, Unit: %, AM307 Only
Temperature	03	67	INT16, Unit: °C, Resolution: 0.1 °C
Humidity	04	68	UINT8, Unit: %, Resolution: 0.5 %
PIR Status	05	00	01: Occupied 00: Vacant
Light Level	06	cb	00: 0-5 lux 01: 6-50 lux 02: 51-100 lux 03: 101-500 lux 04: 501-2000 lux 05: > 2000 lux
CO ₂	07	7d	UINT16, Unit: ppm
TVOC	08	7d	UINT16, Resolution: 0.01
Barometric Pressure	09	73	UINT16, Unit: hPa, Resolution: 0.1 hPa
HCHO	0a	7d	UINT16, Unit: mg/m ³ , Resolution: 0.01 mg/m ³
PM 2.5	0b	7d	UINT16, Unit: µg/m ³
PM 10	0c	7d	UINT16, Unit: µg/m ³
O ₃	0d	7d	UINT16, Unit: ppm
Buzzer Status	0e	01	00: buzzer is disabled 01: buzzer is beeping Note: this only upload when one of the concentrations of air pollutants of CO ₂ , TVOC, PM2.5, PM10, HCHO/O ₃ exceeds the Bad threshold

Example:

1. AM307 Periodic Package

0367ea00 04688a 050001 06cb01 077dcd04 087d5e01 09735127					
Channel	Type	Value	Channel	Type	Value
03	67 (Temperature)	ea 00 => 00 ea = 234 Temp=234*0.1= 23.4°C	04	68 (Humidity)	8a=>138 Hum=138*0. 5=69%
Channel	Type	Value	Channel	Type	Value
05	00	01: Occupied	06	cb (Light Level)	01= level 1 (6-50 lux)
Channel	Type	Value	Channel	Type	Value
07	7d	cd 04 => 04 cd =1229 ppm (CO ₂)	08	7d	5e 01 => 01 5e =350 TVOC=350*0 .01=3.50
Channel	Type	Value			
09	73 (Barometric Pressure)	51 27=>27 51=10044 Pressure=1006 5*0.1=1006.5 hPa			

2. AM308 Periodic Package

0367ea00 04688a 050001 06cb01 077dcd04 087d5e01 09735127 0b7d3b00 0c7d4300					
Channel	Type	Value	Channel	Type	Value
03	67 (Temperature)	ea 00 => 00 ea = 234 Temp=234*0.1=2 3.4°C	04	68 (Humidity)	8a=>138 Hum=138*0. 5=69%
Channel	Type	Value	Channel	Type	Value
05	00	01: Occupied	06	cb (Light Level)	01= level 1 (6-50 lux)
Channel	Type	Value	Channel	Type	Value
07	7d	cd 04 => 04 cd =1229 ppm (CO ₂)	08	7d	5e 01 => 01 5e =350 TVOC=350*0 .01=3.50
Channel	Type	Value	Channel	Type	Value

09	73 (Barometric Pressure)	51 27=>27 51=10044 Pressure=10065* 0.1=1006.5 hPa	0b	7d	3b 00=>00 3b=59 µg/m ³ (PM 2.5)
Channel	Type	Value			
0c	7d	43 00=>00 43=67 µg/m ³ (PM 10)			

3. AM319-HCHO Periodic Package

0367ea00 04688a 050001 06cb01 077dcd04 087d5e01 09735127 0a7d0700 0b7d3b00 0c7d4300					
Channel	Type	Value	Channel	Type	Value
03	67 (Temperature)	ea 00 => 00 ea = 234 Temp=234*0.1=2 3.4°C	04	68 (Humidity)	8a=>138 Hum=138*0. 5=69%
Channel	Type	Value	Channel	Type	Value
05	00	01: Occupied	06	cb (Light Level)	01= level 1 (6-50 lux)
Channel	Type	Value	Channel	Type	Value
07	7d	cd 04 => 04 cd =1229 ppm (CO ₂)	08	7d	5e 01 => 01 5e =350 TVOC=350*0 .01=3.50
Channel	Type	Value	Channel	Type	Value
09	73 (Barometric Pressure)	51 27=>27 51=10044 Pressure=10065* 0.1=1006.5 hPa	0a	7d	07 00=>00 07=7 * 0.01 =0.07 mg/m ³ (HCHO)
Channel	Type	Value	Channel	Type	Value
0b	7d	3b 00=>00 3b=59 µg/m ³ (PM 2.5)	0c	7d	43 00=>00 43=67 µg/m ³ (PM 10)

4. CO₂ value exceeds the Bad threshold.

077d0a060e0100					
Channel	Type	Value	Channel	Type	Value
07	7d	0a 06 => 06 0a =1546 ppm	0e	01	00=>Buzzer is disabled

6.3 Downlink Commands

AM300(L) series sensors support downlink commands to configure the device. The application port is 85 by default.

Channel	Type	Description
ff	03(Reporting Interval)	2 Bytes, unit: s
	10 (Reboot Device)	ff (Reserved)
	17 (Time Zone)	2 Bytes, desired UTC time zone * 10
	1a (CO ₂ Calibration)	00 (Restore Factory Calibration) 03 (Manual Calibration)
	39 (CO ₂ Auto Background Calibration)	00: Disable, 01: Enable
	25 (Button Lock)	00: Disable 01: Lock Screen Display Mode Switch 02: Lock Power On/Off 03: Lock both features
	2c (Enquire LED and Buzzer Mode)	00(Reserved)
	2d (Screen Display)	00: Disable the display 01: Enable the display
	2e (LED Mode)	00: Disable 01: Always On (AM319&AM319L Only) 02: Blink
	3c (Screen Display Mode)	01: Mode 1 02: Mode 2 03: Mode 3
	3d (Stop the Buzzer)	00 (Reserved)
	3e (Set Buzzer Mode)	00: Disable, 01: Enable
	68 (Data Storage)	00: disable, 01: enable
	69 (Data Retransmission)	00: Disable, 01: Enable
	6a (Data Retransmission Interval)	3 Bytes Byte 1: 00 Byte 2-3: interval time, unit:s range: 30~1200s (600s by default)

Example:

1. Set reporting interval as 20 minutes.

ff03b004		
Channel	Type	Value
ff	03 (Set Reporting Interval)	b0 04=>04 b0=1200s =20 minutes

2. Enquire traffic light and buzzer mode.

ff2c00		
Channel	Type	Value
ff	2c (Enquire LED and Buzzer mode)	00(Reserved)

Reply:

ff2e02 ff3e00					
Channel	Type	Value	Channel	Type	Value
ff	2e(LED Mode)	02=Blink	ff	3e (Buzzer Mode)	00=Off

3. Reboot the device.

ff10ff		
Channel	Type	Value
ff	10 (Reboot)	ff (Reserved)

4. Set time zone to GMT-4.

ff17d8ff		
Channel	Type	Value
ff	17 (Set Time Zone)	d8 ff => ffd8 = -40 = -4 * 10

5. Disable the e-ink screen display.

ff2d00		
Channel	Type	Value
ff	2d (Screen Display)	00: Disable the display

6.4 Historical Data Enquiry

AM300(L) series sensors support sending downlink commands to enquire historical data for specified time point or time range. Before that, ensure **the device time is correct and data storage feature was enabled to store the data.**

Command format:

Channel	Type	Description
fd	6b (Enquire data in time point)	4 Bytes, unix timestamp
fd	6c (Enquire data in time range)	Start time (4 bytes) + End time (4 bytes),

		unix timestamp
fd	6d (Stop query data report)	ff
ff	6a (Report Interval)	3 Bytes, Byte 1: 01 Byte 2: interval time, unit: s, range: 30~1200s (60s by default)

Reply format:

Channel	Type	Description
fc	6b/6c	00: data enquiry success 01: time point or time range invalid 02: no data in this time or time range
20	ce (Historical Data)	Data time stamp (4 Bytes) + Data Contents (Mutable)

Note:

1. The device only uploads no more than 300 data records per range enquiry.
2. When enquiring the data in time point, it will upload the data which is closest to the search point within the reporting interval range. For example, if the device reporting interval is 10 minutes and users send command to search for 17:00's data, if the device find there is data stored in 17:00, it will upload this data; if not, it will search for data between 16:50 to 17:10 and upload the data which is closest to 17:00.

Example:

1. Enquire historical data between 2022/9/8 17:43:31 to 2022/9/9 01:45:20.

fd6c c3291a63 b09a1a63		
Channel	Type	Value
fd	6c (Enquire data in time range)	Start time: c3291a63 => 631a29c3 = 1662659011 =2022/9/8 17:43:31 End time: b09a1a63 => 631a9ab0 = 1662659011 =2022/9/9 01:45:20

Reply:

fc6c00		
Channel	Type	Value
fc	6c (Enquire data in time range)	00: data enquiry success

20ce56991a63 ff00 7300 00 00 f802 6400 9127 2200 2600			
Channel	Type	Time Stamp	Value
20	ce (Historical)	56991a63 =>	Temperature: ff00=>00ff=25.5°C

Data)	2022/9/9 01:39:34	Humidity: 7300=>0073=57.5% PIR: 00=> Vacant Light: 00=>Level 0 CO ₂ : f802=>02f8=760 ppm TVOC: 6400=>0064=1.00 Pressure: 9127=>2791=1012.9 hPa PM2.5: 2200=>0022=34 µg/m ³ PM10: 2600=>0026=38 µg/m ³
-------	----------------------	---

Appendix

Carbon Dioxide Levels and Guidelines

CO ₂ Level	Description
400ppm	Normal outdoor air level.
400-1000ppm	Typical level indoors with good ventilation.
1000-2000ppm	Poor air quality - requires ventilation.
≥2000ppm	Headaches, sleepiness and stagnant, stale, stuffy air. Poor concentration, loss of attention, increased heart rate and slight nausea may also be present.
5000ppm	Workplace exposure limit (as 8-hour TWA) in most jurisdictions.
>40000ppm	Exposure may lead to serious oxygen deprivation resulting in permanent brain damage, coma, even death.

TVOC Levels and Guidelines

IAQ Rating	TVOC (mg/m ³)	Air Quality
≤1.99	<0.3	Very Good
2.00 to 2.99	0.3 to 1.0	Good
3.00 to 3.99	1.0 to 3.0	Medium (not recommended for exposure > 12 months)
4.00 to 4.99	3.0 to 10.0	Poor (not recommended for exposure > 1 months)
≥5.00	>10.0	Bad (not recommended)

Note: the conversion from mg/m³ to ppm by the factor is about 0.5 and conversion from ppm to ppb is by the factor 1000.

Illuminance Levels and Guidelines

Level	Illuminance/Lux	Environment Description
Level 0	0-5	No light or minimal street light, twilight.
Level 1	6-50	Cloudy indoor.

Level 2	51-100	Family living room, hallways.
Level 3	101-500	Offices, show rooms, study library, laboratories.
Level 4	501-2000	Supermarkets, drawing work, detailed mechanical workshops, operation theater.
Level 5	>2000	Performance of very prolonged and exacting visual tasks.

-END-