



# Mini Leak Detection Sensor

Featuring LoRaWAN<sup>®</sup>

**WS303**

User Guide



## Safety Precautions

Milesight will not shoulder responsibility for any loss or damage resulting from not following the instructions of this operating guide.

- ❖ The device must not be disassembled or remodeled in any way.
- ❖ In order to protect the security of the device, please change the device password when first configuration. The default password is 123456.
- ❖ Do not place the device close to objects with naked flames.
- ❖ Do not place the device in where the temperature is below/above the operating range.
- ❖ Make sure electronic components do not drop out of the enclosure while opening.
- ❖ When installing the battery, please install it accurately, and do not install the inverse or wrong model.
- ❖ The device must never be subjected to shocks or impacts.

## Declaration of Conformity

WS303 is in conformity with the essential requirements and other relevant provisions of the CE, FCC, and RoHS.

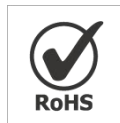

**Copyright © 2011-2023 Milesight. All rights reserved.**

All information in this guide is protected by copyright law. Whereby, no organization or individual shall copy or reproduce the whole or part of this user guide by any means without written authorization from Xiamen Milesight IoT Co., Ltd.

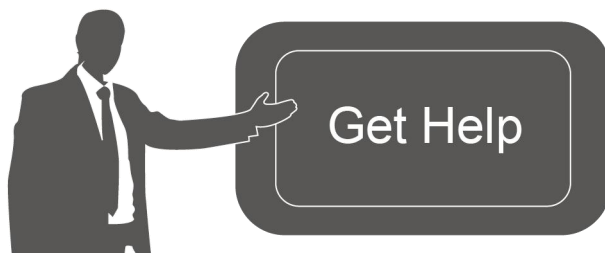

For assistance, please contact

Milesight technical support:

Email: [iot.support@milesight.com](mailto:iot.support@milesight.com)

Support Portal: [support.milesight-iot.com](http://support.milesight-iot.com)

Tel: 86-592-5085280

Fax: 86-592-5023065

Address: Building C09, Software Park III,  
Xiamen 361024, China

## Revision History

Date	Doc Version	Description
March 29, 2023	V 1.0	Initial version

# Contents

1. Product Introduction .....	4
1.1 Overview .....	4
1.2 Features .....	4
2. Hardware Introduction .....	4
2.1 Packing List .....	4
2.2 Hardware Overview .....	5
2.3 Dimensions (mm) .....	5
2.4 Reset Button & Buzzer Patterns .....	5
3. Power Supply .....	6
4. Operation Guide .....	6
4.1 NFC Configuration .....	6
4.2 LoRaWAN Settings .....	7
4.3 Basic Settings .....	10
4.4 Advanced Settings .....	10
4.4.1 Alarm Settings .....	10
4.4.2 Milesight D2D Settings .....	11
4.5 Maintenance .....	11
4.5.1 Upgrade .....	11
4.5.2 Backup .....	12
4.5.3 Reset to Factory Default .....	13
5. Installation .....	14
6. Device Payload .....	14
6.1 Basic Information .....	14
6.2 Sensor Data .....	15
6.3 Downlink Commands .....	15

# 1. Product Introduction

## 1.1 Overview

WS303 is a tiny and mighty leakage detection sensor for detecting the presence of water leaks and transmitting an alarm using LoRaWAN® technology. With this low power consumption technology, WS303 can work up to 5 years with a 590mAh battery. Compliant with Milesight D2D protocol, it can directly link with other Milesight devices to realize danger prevention and effectively prevent unnecessary loss.

The wire-free WS303 can be easily used in smart offices, buildings, and houses. Users can receive real-time alarms via a built-in buzzer locally and a mobile App remotely. Combining with Milesight LoRaWAN® gateway and Milesight IoT Cloud, users can manage all sensor data remotely and visually.

## 1.2 Features

- Detect the presence of conductive liquids using a small water probe
- A replaceable built-in 590mAh battery with up to 5 years of life for wire-free power supply
- IP67 waterproof enclosure for harsh environment applications
- Embedded with a buzzer for real-time alarming
- Support Milesight D2D protocol to enable ultra-low latency and direct control without gateways
- Equipped with NFC for easy configuration
- Compliant with standard LoRaWAN® gateways and network servers
- Quick and easy management with Milesight IoT Cloud solution

## 2. Hardware Introduction

### 2.1 Packing List



1 × WS303  
Device



1 × CR2450  
Battery

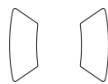

2 × 3M Tapes



1 ×  
Quick Start Guide



**If any of the above items are missing or damaged, please contact your sales representative.**

## 2.2 Hardware Overview

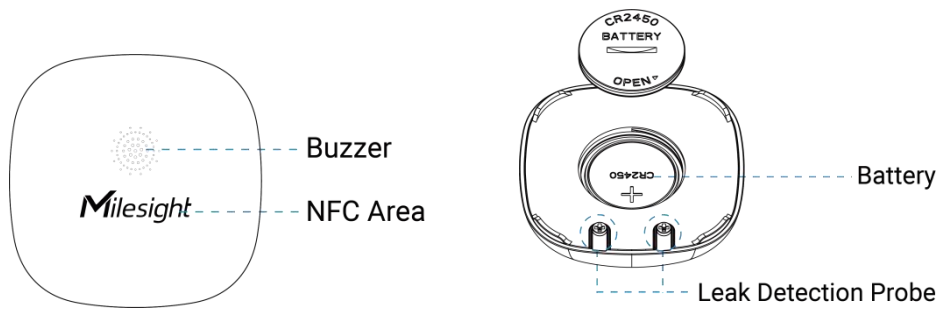

## 2.3 Dimensions (mm)

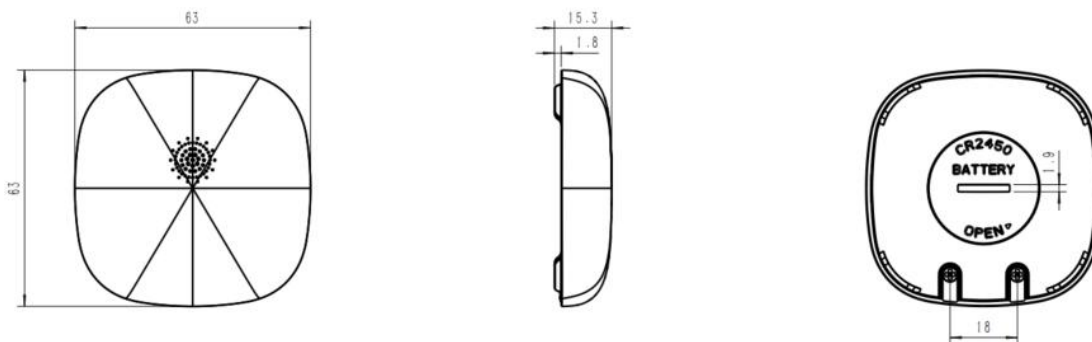

## 2.4 Reset Button & Buzzer Patterns

WS303 sensor equips with a reset button inside the device for emergency reset or reboot even if the battery is removed. Usually, users can use NFC to complete all steps.

Function	Action	Buzzer
Turn On	Insert the battery.	Buzzes for one time
Reboot	Press and hold the button for more than 3 seconds.	Buzzes for every second
Reset to Factory Default	Press and hold the button for more than 10 seconds.	Buzzes for every 0.5 second
Alarm	Detect the leakage	After buzzing five times, the device will buzz for 5 minutes or until the leakage status has been released. (The buzzer can also be stopped via ToolBox App or downlink command)

### 3. Power Supply

1. Put the coin (or any other tool with a suitable size) into the groove of the battery back cover, turn the battery back cover and remove it.
2. Insert the battery into the sensor with the positive facing up. After inserting, the device will power on automatically.
3. Put the battery cover back onto the device and tighten it.

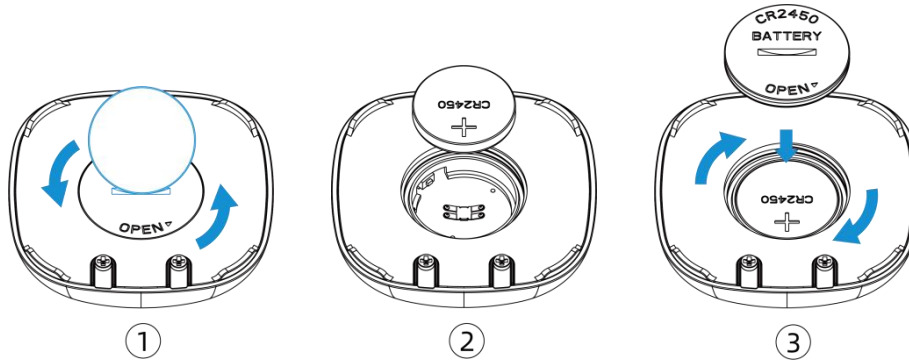

### 4. Operation Guide

#### 4.1 NFC Configuration

WS303 can be configured via NFC.

1. Download and install “Milesight ToolBox” App from Google Play or App Store.
2. Enable NFC on the smartphone and open “Milesight ToolBox” App.
3. Attach the smartphone with NFC area to the device to read the basic information.

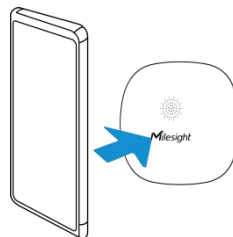

4. Basic information and settings of devices will be shown on ToolBox if it's recognized successfully. You can switch on/off, read and write the device by tapping the button on the App. In order to protect the security of devices, password validation is required when configuring via an unused phone. The default password is **123456**.

Status	Setting	Maintenance
SN	6993C52763220003	
Model	WS303-868M	
Device EUI	24E124993C527632	
Firmware Version	V1.1-a2	
Hardware Version	V1.0	
Device Status		ON

**Note:**

- 1) Ensure the location of the smartphone NFC area and it's recommended to take off the phone case.
- 2) If the smartphone fails to read/write configurations via NFC, keep the phone away and back to try again.
- 3) WS303 can also be configured by a dedicated NFC reader provided by Milesight IoT.

## 4.2 LoRaWAN Settings

Go to **Device > Setting > LoRaWAN Settings** of ToolBox App to configure join type, App EUI, App Key and other information. You can also keep all settings by default.

Device EUI

\* APP EUI

\* Application Port  85

Join Type

\* Application Key

LoRaWAN Version

Parameters	Description																
Device EUI	Unique ID of the device which can also be found on the label.																
App EUI	The default App EUI is 24E124C0002A0001.																
Application Port	The port used for sending and receiving data, the default port is 85.																
Join Type	OTAA and ABP modes are available.																
Application Key	Appkey for OTAA mode, default is 5572404C696E6B4C6F52613230313823.																
Device Address	DevAddr for ABP mode, default is the 5 <sup>th</sup> to 12 <sup>th</sup> digits of SN.																
Network Session Key	Nwkskey for ABP mode, default is 5572404C696E6B4C6F52613230313823.																
Application Session Key	Appskey for ABP mode, default is 5572404C696E6B4C6F52613230313823.																
LoRaWAN Version	V1.0.2 and V1.0.3 are available.																
Work Mode	It's fixed as Class A.																
RX2 Data Rate	RX2 data rate to receive downlinks or send D2D commands.																
RX2 Frequency	RX2 frequency to receive downlinks or send D2D commands. Unit: Hz																
Channel Mode	Select Standard-Channel mode or Single-Channel mode. When Single-Channel mode is enabled, only one channel can be selected to send uplinks. Please enable Single-Channel mode if you connect the device to DS7610.																
Channel	<p>Enable or disable the frequency to send uplinks.</p> <p>* Support Frequency</p> <div style="border: 1px solid #ccc; padding: 5px; margin-bottom: 10px;"> <input type="text" value="EU868"/> </div> <table style="width: 100%; border-collapse: collapse;"> <tbody> <tr> <td style="text-align: center;"><input checked="" type="checkbox"/></td> <td style="text-align: center;">-</td> <td style="text-align: center;">868.1</td> <td style="text-align: center;">+</td> </tr> <tr> <td style="text-align: center;"><input checked="" type="checkbox"/></td> <td style="text-align: center;">-</td> <td style="text-align: center;">868.3</td> <td style="text-align: center;">+</td> </tr> <tr> <td style="text-align: center;"><input checked="" type="checkbox"/></td> <td style="text-align: center;">-</td> <td style="text-align: center;">868.5</td> <td style="text-align: center;">+</td> </tr> <tr> <td style="text-align: center;"><input type="checkbox"/></td> <td style="text-align: center;">-</td> <td style="text-align: center;">863</td> <td style="text-align: center;">+</td> </tr> </tbody> </table> <p>If the frequency is one of CN470/AU915/US915, enter the index of the channel that you want to enable and make them separated by commas.</p> <p><b>Examples:</b></p> <p>1, 40: Enabling Channel 1 and Channel 40</p> <p>1-40: Enabling Channel 1 to Channel 40</p> <p>1-40, 60: Enabling Channel 1 to Channel 40 and Channel 60</p> <p>All: Enabling all channels</p>	<input checked="" type="checkbox"/>	-	868.1	+	<input checked="" type="checkbox"/>	-	868.3	+	<input checked="" type="checkbox"/>	-	868.5	+	<input type="checkbox"/>	-	863	+
<input checked="" type="checkbox"/>	-	868.1	+														
<input checked="" type="checkbox"/>	-	868.3	+														
<input checked="" type="checkbox"/>	-	868.5	+														
<input type="checkbox"/>	-	863	+														



	<p>Null: Indicates that all channels are disabled</p> <p>* Support Frequency</p> <p>AU915</p> <p>Enable Channel Index ⓘ</p> <p>8-15</p> <table border="1"> <thead> <tr> <th>Index</th> <th>Frequency/MHz ⓘ</th> </tr> </thead> <tbody> <tr> <td>0 - 15</td> <td>915.2 - 918.2</td> </tr> <tr> <td>16 - 31</td> <td>918.4 - 921.4</td> </tr> <tr> <td>32 - 47</td> <td>921.6 - 924.6</td> </tr> <tr> <td>48 - 63</td> <td>924.8 - 927.8</td> </tr> <tr> <td>64 - 71</td> <td>915.9 - 927.1</td> </tr> </tbody> </table>	Index	Frequency/MHz ⓘ	0 - 15	915.2 - 918.2	16 - 31	918.4 - 921.4	32 - 47	921.6 - 924.6	48 - 63	924.8 - 927.8	64 - 71	915.9 - 927.1
Index	Frequency/MHz ⓘ												
0 - 15	915.2 - 918.2												
16 - 31	918.4 - 921.4												
32 - 47	921.6 - 924.6												
48 - 63	924.8 - 927.8												
64 - 71	915.9 - 927.1												
Spread Factor	If ADR is disabled, the device will send data via this spread factor.												
Confirmed Mode	If the device does not receive an ACK packet from the network server, it will resend data once.												
Rejoin Mode	<p>Reporting interval <math>\leq</math> 30 mins: the device will send a specific number of LinkCheckReq MAC packets to the network server every 30 mins to validate connectivity; if there is no response, the device will rejoin the network.</p> <p>Reporting interval <math>&gt;</math> 30 mins: the device will send a specific number of LinkCheckReq MAC packets to the network server every reporting interval to validate connectivity; if there is no response, the device will rejoin the network.</p>												
Set the number of packets sent	When rejoin mode is enabled, set the number of LinkCheckReq packets sent.												
ADR Mode	Allow the network server to adjust datarate of the device. This only works with Standard Channel Mode.												
Tx Power	Transmit power of the device.												

**Note:**

- 1) Please contact sales for the device EUI list if there are many units.
- 2) Please contact sales if you need random App keys before purchase.
- 3) Select OTAA mode if you use Milesight IoT Cloud to manage devices.

#### 4) Only OTAA mode supports rejoin mode.

### 4.3 Basic Settings

Go to **Device > Setting > General Settings** to change the reporting interval, etc.

Reporting Interval  min

Buzzer

Change Password

Parameters	Description
Reporting Interval	Reporting interval of transmitting data to the network server. Range: 1~1080mins; Default: 1080mins
Buzzer	Enable or disable the buzzer for alarming when the sensor detects leakage. The buzzer will automatically stop after 5 minutes or the status returns to "No Leak".
Change Password	Change the password for ToolBox App or software to read/write this device.

### 4.4 Advanced Settings

#### 4.4.1 Alarm Settings

Go to **Device > Settings > Alarm Settings** to enable the alarm settings. When WS303 detects water leakage, it will report the alarm according to reporting interval and reporting times settings.

Alarm Reporting

If water leakage occurs, the alarm reporting interval and the alarm reporting times can be set as follows

Alarm Reporting Interval  min

Alarm Reporting Times

Parameters	Description
Alarm Reporting Interval	Reporting interval of sending alarm packet. Default: 1min
Alarm Reporting Times	The times of reporting alarm packet. Range: 2~1000; Default: 2

## 4.4.2 Milesight D2D Settings

Milesight D2D protocol is developed by Milesight and used for setting up transmission among Milesight devices without gateway. When the Milesight D2D setting is enabled, WS303 can work as a Milesight D2D controller to send control commands to trigger Milesight D2D agent devices.

1. Configure RX2 datarate and RX2 frequency in LoRaWAN® settings, it is suggested to change the default value if there are many LoRaWAN® devices around.
2. Go to **Device > Settings > D2D Settings** to enable D2D function, and define a unique Milesight D2D key which is the same as Milesight D2D agent devices, then select the frequency and spreading factor. (Default Milesight D2D Key: 5572404C696E6B4C6F52613230313823)

Enable

D2D Key

3. Enable one of WS303 statuses and configure a 2-byte hexadecimal command (This command is pre-defined in Milesight D2D agent device). When WS303 detects this status, it will send the control command to the corresponding Milesight D2D agent devices.

Sensor Status: Leak

Control command

LoRa Uplink ⓘ

Sensor Status: No Leak

**Note:** If you enabled **LoRa Uplink** feature, LoRaWAN® uplink that contains the Leakage status will be sent to the gateway after Milesight D2D control command is sent.

## 4.5 Maintenance

### 4.5.1 Upgrade

1. Download firmware from Milesight website to your smartphone.
2. Open Toolbox App, go to **Device > Maintenance** and click **Browse** to import firmware and upgrade the device.

**Note:**

- 1) Operation on ToolBox is not supported during a firmware upgrade.
- 2) Only the Android version of ToolBox supports the upgrade feature.

Status	Setting	Maintenance
SN	6993C52763220003	
Model	WS303-868M	
Firmware Version	V1.1-a2	
Hardware Version	V1.0	
Manual Upgrade		
<input type="button" value="Browse"/>		

#### 4.5.2 Backup

WS303 supports configuration backup for easy and quick device configuration in bulk. Backup is allowed only for devices with the same model and LoRaWAN® frequency band.

1. Go to **Template** page on the App and save the current settings as a template. You can also edit the template file.
2. Select one template file which saved in the smartphone and click **Write**, then attach the smartphone to another device to write the configuration.

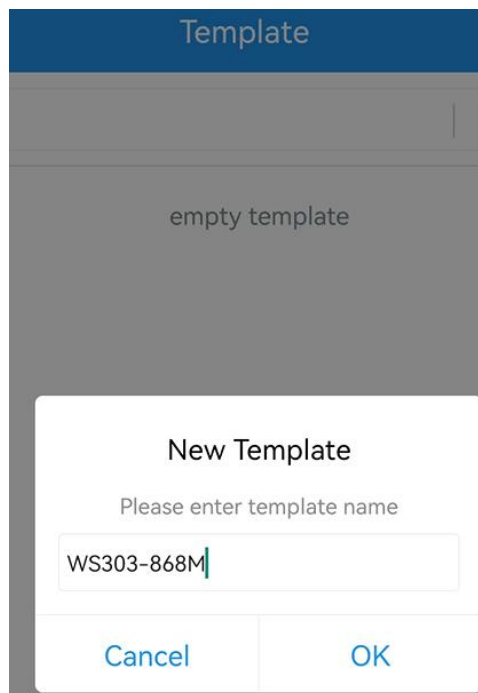

**Note:** Slide the template item left to edit or delete the template. Click the template to edit the configurations.

Template	
<input type="text"/>	<input type="text"/>
<input type="checkbox"/> EM500-UDL-868M_20201124 Last Modified Time: 2020-11-24 17:06:26	
<input type="checkbox"/> EM300-TH-915M_20210112 Last Modified Time: 2021-01-12 14:35:12	
<input type="checkbox"/> UC512-DI-868M_20210128 Last Modified Time: 2021-01-28 16:57:20	
<input type="checkbox"/> UC501-470M_20210201 Last Modified Time: 2021-02-01 11:29:43	
<input type="checkbox"/> M_20210208 Last Modified Time: 2021-02-08 16:44:37	<input type="button" value="Edit"/> <input type="button" value="Delete"/>

### 4.5.3 Reset to Factory Default

Please select one of the following methods to reset the device:

**Via Hardware:** Hold on the power button (internal) for more than 10s.

**Via ToolBox App:** Go to **Device > Maintenance** to click **Reset**, then attach the smartphone with NFC area to the device to complete reset.

Status	Setting	Maintenance
SN	6993C52763220003	
Model	WS303-868M	
Firmware Version	V1.1-a2	
Hardware Version	V1.0	
Manual Upgrade		
<input type="button" value="Browse"/>		
Restore Factory Default		
<input type="button" value="Reset"/>		

## 5. Installation

### Fixed by 3M Tape:

Paste 3M tape to the back cover, then tear off the other side and place it on the wall near the detection area (please make sure the two leak detection probe is straight down).

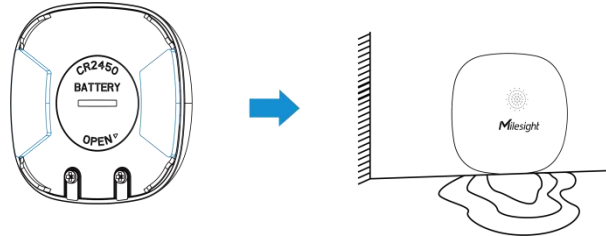

### Placement Installation:

Place the sensor facing up and horizontally in the detection area.

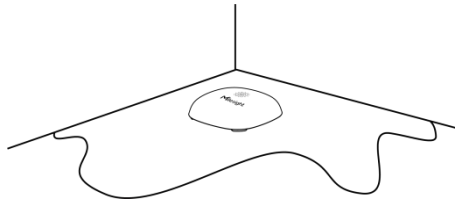

## 6. Device Payload

All data are based on the following format (HEX), the Data field should follow little-endian:

Channel1	Type1	Data1	Channel2	Type2	Data2	Channel 3	...
1 Byte	1 Byte	N Bytes	1 Byte	1 Byte	M Bytes	1 Byte	...

For decoder examples please find files on <https://github.com/Milesight-IoT/SensorDecoders>.

### 6.1 Basic Information

WS303 reports basic information about the sensor every time it joins the network.

Channel	Type	Description
ff	01(Protocol Version)	01=>V1
	09 (Hardware Version)	01 40 => V1.4
	0a (Software Version)	01 14 => V1.14
	0b (Power On)	Device is on
	0f (Device Type)	00: Class A, 01: Class B, 02: Class C
	16 (Device SN)	16 digits

#### Example:

ff0bff ff0101 ff166993c52763220003 ff090100 ff0a0101 ff0f00					
Channel	Type	Value	Channel	Type	Value
ff	0b (Power On)	ff (Reserved)	ff	01 (Protocol Version)	01 (V1)
Channel	Type	Value	Channel	Type	Value
ff	16 (Device SN)	6993c52763 220003	ff	09 (Hardware version)	0100 (V1.0)
Channel	Type	Value	Channel	Type	Value
ff	0a (Software version)	0101 (V1.1)	ff	0f (Device Type)	00 (Class A)

## 6.2 Sensor Data

WS303 reports sensor data according to reporting interval (1080mins by default) or leakage status changes.

Channel	Type	Description
01	75(Battery Level)	UINT8, Unit: %
03	00 (Leakage Status)	00: No leak 01: Leaking detected

### Example:

#### 1. Periodic Packet

017563 030001					
Channel	Type	Value	Channel	Type	Value
01	75 (Battery)	63 => 99%	03	00 (Leakage Status)	01=>Leaking detected

#### 2. Alarm Packet:

030001		
Channel	Type	Value
03	00 (Leakage Status)	01=> Leaking detected

## 6.3 Downlink Commands

WS303 supports downlink commands to configure the device. The application port is 85 by default.

Channel	Type	Description
ff	10 (Reboot)	ff (Reserved)

03 (Set Reporting Interval)	2 Bytes, unit: s
3e (Set Buzzer)	00 = Disable; 01 = Enable
3d (Stop Buzzing)	ff (Reserved)
7e (Set Alarming Reporting)	5 Bytes, Alarm Reporting(1 Byte)+Interval(2 Bytes)+ Times(2 Bytes) Alarm Reporting: 00 = Disable; 01 = Enable Alarm Reporting Interval: unit --s Alarm Reporting Times: range --2~1000
7f (Set Searching Device)	00 = Not Search; 01 = Search  <b>Note:</b> 1. The device will buzz for a specific time after receiving this downlink command. 2. You can stop the buzzer on ToolBox or by sending the not search downlink command. 3. Disabling the buzzer on Toolbox will not stop the buzzing under searching device feature.
80 (Set Buzzing Time when Searching)	2 Bytes, unit:s Range: 60~64800; Default: 300s
84 (Set D2D Function)	00=Disable; 01=Enable
81 (Set LoRa Uplink)	2 Bytes, Status(1 Byte)+Function(1 Byte)  <b>Status:</b> 00=No Leak; 01=Leak <b>Function:</b> 00 -Only Use LoRaWAN 01 -Only Use D2D 03 -Use D2D&LoRaWAN Uplink
83 (Set D2D Command)	3 Bytes, Status(1 Byte)+Command(2 Bytes) Status: 00=No Leak; 01=Leak



**Example:**

1. Set reporting interval as 20 minutes.

ff03b004		
Channel	Type	Value
ff	03 (Set Reporting Interval)	b0 04 => 04 b0 = 1200s = 20 minutes

2. Reboot the device.

ff10ff		
Channel	Type	Value
ff	10 (Reboot)	ff (Reserved)

3. Enable buzzer for leakage alarming.

ff3e01		
Channel	Type	Value
ff	3e (Set Buzzer)	01=>Enable

4. Stop buzzing when WS303 detects water leakage.

ff3dff		
Channel	Type	Value
ff	3d (Stop Buzzing)	ff (Reserved)

5. Enable alarming reporting, set the interval as 10 minutes and set the reporting times as 3.

ff7e 01 5802 0300		
Channel	Type	Value
ff	7e (Set Alarm Reporting)	01=> Enable Alarm Reporting 58 02 => 02 58 = 600s = 10 minutes 03 00 => 00 03 =3

6. Enable D2D function.

ff8401		
Channel	Type	Value
ff	84 (Set D2D Function)	01 => Enable

7. Set leak status using both D2D&LoRa uplink.

ff81 01 03		
Channel	Type	Value
ff	81 (Set LoRa Uplink)	Status: 01=> Leak Function: 03=> Use D2D & LoRa

8. Set the D2D command of leak as 0101.

ff83 01 0101		
Channel	Type	Value
ff	83 (Set D2D Command)	Status: 01=> Leak Command: 0101

**-END-**