



Indoor Ambiance Monitoring Sensor

Featuring LoRaWAN[®]

AM100 Series(AM104 & AM107)

User Guide



Applicability

This guide is applicable to AM100 series sensors shown as follows, except where otherwise indicated.

Model	Description
AM104	Indoor Ambiance Sensor(Temp, Hum, Light, Motion)
AM107	Indoor Ambiance Sensor(Temp, Hum, Light, Motion, CO2, TVOC, Pressure)

Safety Precautions

Milesight will not shoulder responsibility for any loss or damage resulting from not following the instructions of this operating guide.

- ❖ The device must not be disassembled or remodeled in any way.
- ❖ In order to protect the security of the device, please change device password when first configuration. Default password is 123456.
- ❖ Do not place the device outdoors where the temperature is below/above operating range. Do not place the device close to objects with naked flames, heat source (oven or sunlight), cold source, liquid and extreme temperature changes.
- ❖ The device is not intended to be used as a reference sensor, and Milesight will not should responsibility for any damage which may result from inaccurate readings.
- ❖ The battery should be removed from the device if it is not to be used for an extended period. Otherwise, the battery might leak and damage the device. Never leave a discharged battery in the battery compartment.
- ❖ The device must never be subjected to shocks or impacts.
- ❖ Do not clean the device with detergents or solvents such as benzene or alcohol. To clean the device, wipe with a soft moistened cloth. Use another soft, dry cloth to wipe dry.

Declaration of Conformity

AM100 series is in conformity with the essential requirements and other relevant provisions of the CE, FCC, and RoHS.

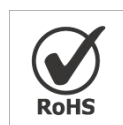

Copyright © 2011-2022 Milesight. All rights reserved.

All information in this guide is protected by copyright law. Whereby, no organization or individual shall copy or reproduce the whole or part of this user guide by any means without written authorization from Xiamen Milesight IoT Co., Ltd.

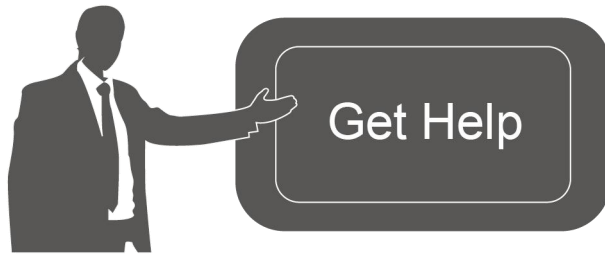

For assistance, please contact

Milesight technical support:

Email: iot.support@milesight.com

Tel: 86-592-5085280

Fax: 86-592-5023065

Address: Building C09, Software Park III,
Xiamen 361024, China

Revision History

Date	Doc Version	Description
Apr. 7, 2020	V 1.0	Initial version
May 19, 2020	V 1.1	App pictures replacement
Aug. 26, 2020	V 1.2	Add screen display mode and configuration examples
Sept.14, 2020	V 1.3	Add screen alarm settings
Nov. 19, 2020	V 2.0	Layout replace
Mar. 2, 2021	V 2.1	Change model from AM100/AM102 to AM104/AM107
Oct. 9, 2021	V 2.2	Add downlink commands

Contents

1. Product Introduction.....	5
1.1 Overview.....	5
1.2 Features.....	5
2. Hardware Introduction.....	5
2.1 Packing List.....	5
2.2 Hardware Overview.....	6
2.3 E-ink Screen.....	6
2.3.1 Screen Description.....	6
2.3.2 Screen Mode Switch.....	8
2.4 Power Button.....	8
2.5 Dimensions.....	8
3. Power Supply.....	9
4. Operation Guide.....	9
4.1 Log in the ToolBox.....	9
4.1.1 NFC Configuration.....	9
4.1.2 USB Configuration.....	10
4.2 LoRaWAN Settings.....	11
4.3 Time Synchronization.....	14
4.4 Basic Settings.....	15
4.5 Advanced Settings.....	15
4.5.1 Data Collection Settings.....	15
4.5.2 Calibration Settings.....	16
4.5.3 Threshold Settings.....	17
4.6 Maintenance.....	17
4.6.1 Upgrade.....	17
4.6.2 Backup.....	18
4.6.3 Reset to Factory Default.....	19
5. Installation.....	20
6. Milesight IoT Cloud Management.....	21
7. Device Payload.....	22
7.1 Basic Information.....	23
7.2 Sensor Data.....	23
7.3 Downlink Commands.....	25
Appendix.....	26
Carbon Dioxide Levels and Guidelines.....	26

1. Product Introduction

1.1 Overview

AM100 series is a compact indoor ambience monitoring sensor including motion, humidity, temperature, light, TVOC, CO₂, barometric pressure for wireless LoRa network. AM100 series is a battery powered device and is designed to be wall-mounted. It is equipped with NFC (Near Field Communication) and can easily be configured via a smartphone or a PC software.







Sensor data are transmitted in real-time using standard LoRaWAN[®] protocol. LoRaWAN[®] enables encrypted radio transmissions over long distance while consuming very little power. The user can obtain sensor data and view the trend of data change through Milesight IoT Cloud or through the user's own Network Server.

1.2 Features

- Robust LoRa connectivity for indoor or HVAC environments
- Integrated multiple sensors like temperature, humidity, light, air quality, etc.
- Easy configuration via NFC
- Visual display via E-Ink screen
- Standard LoRaWAN[®] support
- Milesight IoT Cloud compliant
- Low power consumption (about 1 year battery life)
- Standard AA alkaline battery

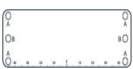
2. Hardware Introduction

2.1 Packing List

					
1 ×	2 ×	1 ×	2 ×	1 ×	1 ×
AM104/AM107	AA Batteries (LR6)	Mounting Sticker	Wall Mounting Kits	Warranty Card	Quick Guide



If any of the above items is missing or damaged, please contact your sales Representative.

2.2 Hardware Overview

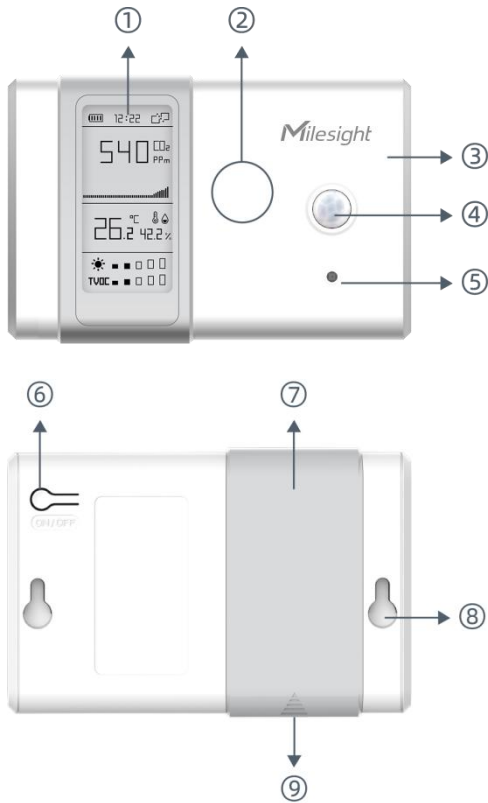

Front Panel:

- ① E-ink screen
- ② NFC Area
- ③ LoRa Antenna (Internal)
- ④ PIR Sensor
- ⑤ Light Sensor

Back Panel:

- ⑥ Power button
- ⑦ Battery Cover
- ⑧ Mounting Holes
- ⑨ Type-C Port

2.3 E-ink Screen

2.3.1 Screen Description

AM100 series provide 3 types of display modes:

AM104		
Mode 1	Mode 2	Mode 3
AM107		
Mode 1	Mode 2	Mode 3

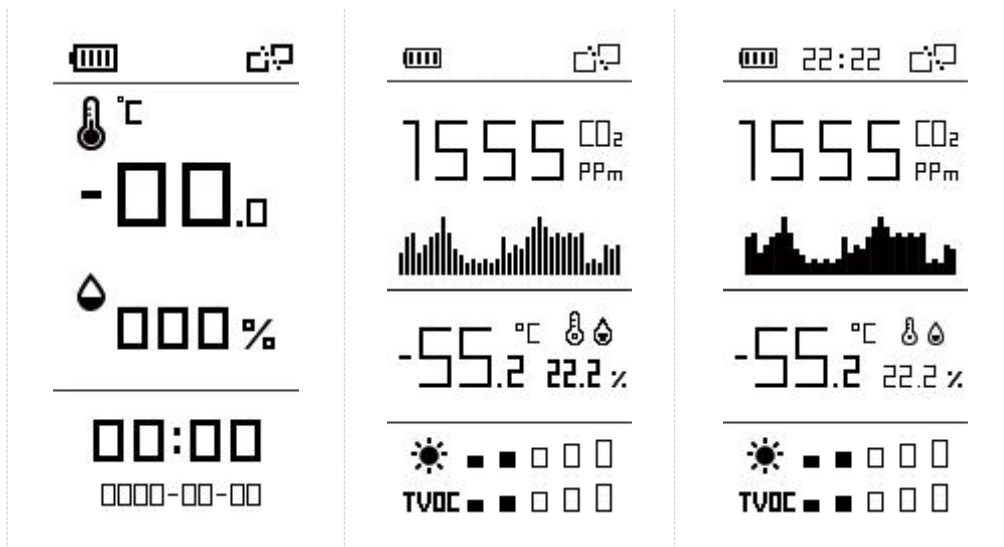

To learn what an icon means, find it below.

Icon	Description	Screen Update
	Battery level	24 hours
22:22	Sync time with software or mobile App	1 min
	The device joins the network.	According to join status
	The device fails to join the network.	
	Temperature	1 min
	Humidity	1 min
	Level 0: 0-5 lux Level 1: 6-50 lux Level 2: 51-100 lux Level 3: 101-400 lux Level 4: 401-700 lux Level 5: ≥701 lux	1 min
	Level 0: 0-100 ppb Level 1: 101-200 ppb Level 2: 201-250 ppb Level 3: 251-300 ppb Level 4: 301-350 ppb Level 5: 351-400 ppb	1 min
	Show alarm when TVOC exceeds the threshold value.(400 ppb by default)	
	Show CO ₂ history tendency from 0 to 1400ppm.	2 min
	Show alarm when CO ₂ exceeds the threshold value.(1200 ppm by default)	

Note:

- AM100 series will do a full-screen refresh every 30 minutes in order to remove ghosting.
- Please refer [section 4.5.3](#) for TVOC and CO₂ threshold settings.
- AM100 series shows current value on the screen and uplink the average value of the reporting interval to the gateway.

2.3.2 Screen Mode Switch

Here are 3 methods to switch between the three modes:

- Power button: Quick press the power button to switch the mode.
- Mobile App: Go to Milesight ToolBox App menu "Device > Setting > General Settings" to select screen display mode.
- Software: Go to Toolbox menu "Device Settings > Basic > Basic Settings" to select screen display mode.

2.4 Power Button

AM100 series can be turned on/off or reset by power button on the rear panel.

Function	Action
Turn On	Press and hold the power button for more than 3 seconds until the screen changes state.
Turn Off	Press and hold the power button for more than 3 seconds until the screen changes state.
Reset to Factory Default	Press and hold the power button for more than 10 seconds.
Change Screen Mode	Quick press the power button.

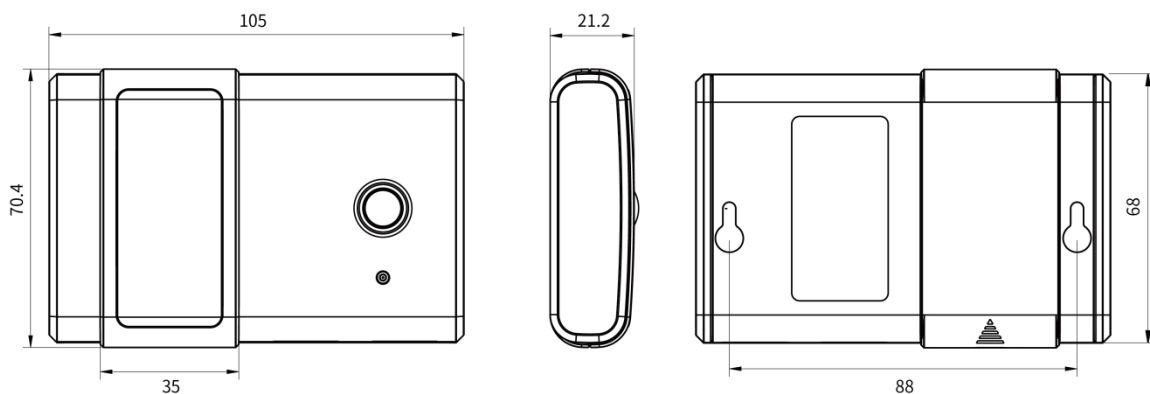
2.5 Dimensions(mm)

3. Power Supply

Remove the battery cover and install two new AA/LR6 batteries. Batteries can be replaced on the fly.

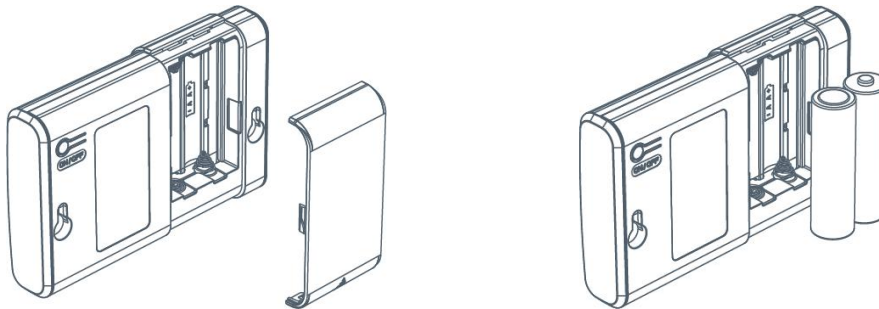

Note:

- AM100 series can also be powered by type-C USB port (5V, 100mA). When batteries and external power are both connected, external power will be the preferred power supply option.
- Both AA batteries are connected in series, so please ensure your battery voltage is not more than 1.5V.
- USB port can't be used to charge battery.

4. Operation Guide

4.1 Log in the ToolBox

AM100 series can be monitored and configured via ToolBox App or ToolBox software. Please select one of them to complete configuration.

4.1.1 NFC Configuration

1. Download and install "Milesight ToolBox" App from Google Play or Apple App Store.
2. Enable NFC on the smartphone and launch Milesight ToolBox.
3. Attach the smartphone with NFC area to the device to read device information. Basic information and settings of the device will be shown on ToolBox App if it's recognized successfully. You can turn on/off, read and configure the device on the App. In order to protect the security of the device, please change password when first configuration. The default password is **123456**.

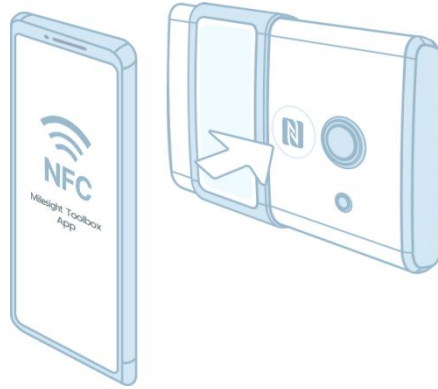
**Note:**

- 1) Ensure the location of smartphone NFC area and it's recommended to take off phone case.
- 2) If the smartphone fails to read/write configurations via NFC, keep the phone away and back to try again.
- 3) AM100 series can also be configured by dedicated NFC reader, which can be purchased from Milesight IoT.

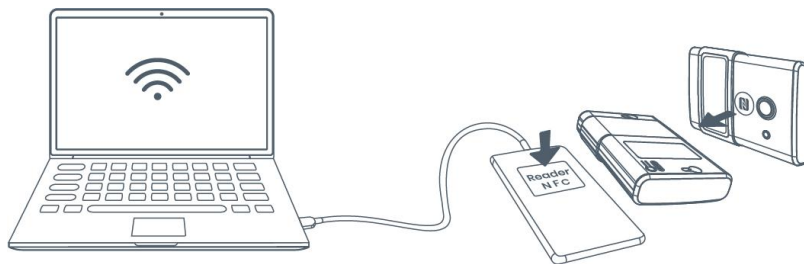
**4.1.2 USB Configuration**

1. Download ToolBox software from www.milesight-iot.com.
2. Connect the device to a computer via Type-C port.



3. Open the ToolBox and select type as "General", then click password to log in ToolBox.
(Default password: **123456**)

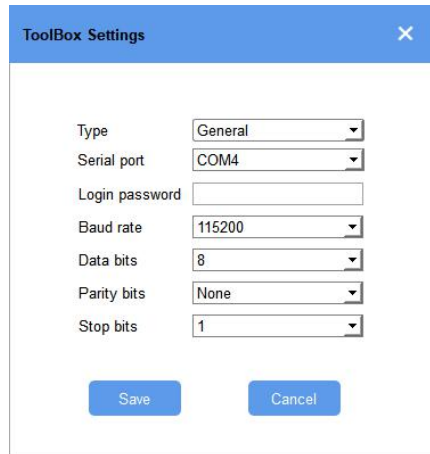

ToolBox Settings

Type: General

Serial port: COM4

Login password:

Baud rate: 115200

Data bits: 8

Parity bits: None

Stop bits: 1

Save Cancel

4. After logging in the ToolBox, you can click “Power On” or “Power Off” to turn on/off device and change other settings.

Status >

[Read](#)[Power On](#)

Model:	AM107-915M
Serial Number:	6128A2347936
Device EUI:	24e124128a234793
Firmware Version:	01.35
Hardware Version:	1.4
Device Status:	Off
Join Status:	-
RSSI/SNR:	-

4.2 LoRaWAN Settings

LoRaWAN settings is used for configuring the transmission parameters in LoRaWAN[®] network.

Step 1: Go to “**LoRaWAN Settings -> Basic**” of ToolBox software or “**Device->Setting->LoRaWAN Settings**” of ToolBox App to configure join type, App EUI, App Key and other information. You can also keep all settings by default.

Device EUI	<input type="text" value="24E124127A270222"/>
App EUI	<input type="text" value="24E124C0002A0001"/>
Application Port	<input type="text" value="85"/>
Join Type	<input type="text" value="OTAA"/>
LoRaWAN Version	<input type="text" value="V1.1.0"/>
Application Key	<input type="text" value="*****"/>
Spread Factor	<input type="text" value="SF10-DR2"/>
Confirmed Mode	<input type="checkbox"/>
Rejoin Mode	<input checked="" type="checkbox"/>
Set the number of packets sent	<input type="text" value="32"/> packets
ADR Mode	<input checked="" type="checkbox"/>

Parameters	Description
Device EUI	Unique ID of the device which can also be found on the label.
App EUI	Default App EUI is 24E124C0002A0001.
Application Port	The port used for sending and receiving data, default port is 85.
Join Type	OTAA and ABP mode are available.
LoRaWAN Version	V1.0.2, V1.0.3, V1.1 are available.
Application Key	Appkey for OTAA mode, default is 5572404C696E6B4C6F52613230313823.
Device Address	DevAddr for ABP mode, default is the 5 th to 12 th digits of SN.
Network Session Key	Nwkskey for ABP mode, default is 5572404C696E6B4C6F52613230313823.
Application Session Key	Appskey for ABP mode, default is 5572404C696E6B4C6F52613230313823.
Spread Factor	If ADR is disabled, the device will send data via this spread factor.
Confirmed Mode	If the device does not receive ACK packet from network server, it will resend data 3 times at most.
Rejoin Mode	Reporting interval \leq 30 mins: device will send specific amounts of LoRaMAC packets to check connection status every 30 mins; If there is no reply after specific amount of packets sent, the device will re-join. Reporting interval $>$ 30 mins: device will send specific amounts of LoRaMAC packets to check connection status every reporting interval; If there is no reply after specific amounts of packets sent, the device will re-join.

ADR Mode	Allow network server to adjust datarate of the device.
Tx Power	Transmit power of device.

Note:

- 1) Please contact sales for device EUI list if there are many units.
- 2) Please contact sales if you need random App keys before purchase.
- 3) Select OTAA mode if you use Milesight IoT cloud to manage devices.
- 4) Only OTAA mode supports rejoin mode.

Step 2: Go to “LoRaWAN -> Channel” of ToolBox software or “Setting->LoRaWAN Settings” of ToolBox App to select supported frequency and select channels to send uplinks. Make sure the channels match the LoRaWAN® gateway.

Support Frequency : EU868				
<input type="checkbox"/>	Index	Frequency/MHz	Max Datarate	Min Datarate
<input checked="" type="checkbox"/>	0	868.1	5-SF7BW125	0-SF12BW125
<input checked="" type="checkbox"/>	1	868.3	5-SF7BW125	0-SF12BW125
<input checked="" type="checkbox"/>	2	868.5	5-SF7BW125	0-SF12BW125
<input type="checkbox"/>	3	0	5-SF7BW125	0-SF12BW125
<input type="checkbox"/>	4	0	5-SF7BW125	0-SF12BW125
<input type="checkbox"/>	5	0	5-SF7BW125	0-SF12BW125
<input type="checkbox"/>	6	0	5-SF7BW125	0-SF12BW125
<input type="checkbox"/>	7	0	5-SF7BW125	0-SF12BW125

If frequency is one of CN470/AU915/US915, you can enter the index of the channel that you want to enable in the input box, making them separated by commas.

Examples:

- 1, 40: Enabling Channel 1 and Channel 40
- 1-40: Enabling Channel 1 to Channel 40
- 1-40, 60: Enabling Channel 1 to Channel 40 and Channel 60
- All: Enabling all channels
- Null: Indicates that all channels are disabled

Support Frequency : AU915

Enabled Channel Index: 0-71

Channel Index	Frequency/MHz	Channel Spacing/MHz	BW/kHz
0 - 15	915.2 - 918.2	0.2	125
16 - 31	918.4 - 921.4	0.2	125
32 - 47	921.6 - 924.6	0.2	125
48 - 63	924.8 - 927.8	0.2	125
64 - 71	915.9 - 927.1	1.6	500

Note:
 For -868M model, default frequency is EU868;
 For -915M model, default frequency is AU915.

4.3 Time Synchronization

Mobile App Configuration:
 Go to "Device ->Status" to click "sync" to sync the time on the screen.
Software Configuration:
 Go to "Status" page to sync the time on the screen.

The screenshot shows the 'Status' page of a mobile application. On the left is a configuration panel with a 'Status' tab selected. It lists various device settings such as Device Status (ON), Join Status (Activated), RSSI/SNR (-44/9), Device Time (1970-01-24 09:10), Temperature (27.0 °C), Humidity (58.5%), Activity Level (PIR) (1), Illumination (89 lux), Battery (61%), and Channel Mask (0003). A 'Read' button is at the bottom of this panel. On the right is a larger 'Status >' view showing detailed sensor data: Device Status (On), Join Status (De-Activate), RSSI/SNR (0/0), Temperature (Disabled), Humidity (61.5%), Activity Level (PIR) (40), Illumination (85 lux), CO2 (585 ppm), TVOC (210 ppb), Barometric Pressure (1006.1 hPa), Battery (92%), Channel Mask (000000000000000000000000f), Uplink Frame-counter (0), Downlink Frame-counter (0), and Device Time (2020-08-21 13:18:12). A 'Sync' button is highlighted in red at the bottom right of this view.

4.4 Basic Settings

Go to “**Device Settings->Basic**” of ToolBox software or “**Device->Setting->General Settings**” of ToolBox App to change the reporting interval, screen mode, etc.

Reporting Interval	<input type="text" value="10"/>	min
Temperature Unit	<input type="text" value="°C"/>	▼
Screen Smart Mode	<input checked="" type="checkbox"/>	
Screen Display Mode	<input type="text" value="Mode1(display time,Temp and RH)"/>	▼
Change Password	<input type="checkbox"/>	

Parameters	Description
Reporting Interval	Reporting interval of transmitting data to network server.Default: 10 mins Range: 1-1080 mins
Temperature Unit	Change the temperature unit displayed on the ToolBox and screen. Note: 1) The temperature unit in the reporting package is fixed as °C. 2) Please modify the threshold settings if the unit is changed.
Screen Smart Mode	When PIR value is 0 and last for 20 mins, the screen will stop updating to save battery life.
Screen Display Mode	Change the screen display contents(see section 2.3).
Change Password	Change the password for ToolBox App or software to read/write this device.

4.5 Advanced Settings

4.5.1 Data Collection Settings

Go to “**Device Settings->Basic**” of ToolBox software or “**Device->Setting->Data Collection Settings**” of ToolBox App to select the data you need to monitor. If any item disabled, the screen will stop updating it and there will not data on the reporting package.

Temperature	<input checked="" type="checkbox"/>
Humidity	<input checked="" type="checkbox"/>
Activity Level (PIR)	<input checked="" type="checkbox"/>
Illumination	<input checked="" type="checkbox"/>
CO2	<input checked="" type="checkbox"/>
TVOC	<input checked="" type="checkbox"/>
Barometric Pressure	<input checked="" type="checkbox"/>

4.5.2 Calibration Settings

ToolBox supports numerical calibration for all items. Go to “**Device Settings->Basic**” of ToolBox software or “**Device->Setting->Calibration Settings**” of ToolBox App to type the calibration value and save, the device will add the calibration value to raw value.

Temperature Calibration	<input checked="" type="checkbox"/>
Current Raw Value	0 °C
Calibration Value	<input type="text" value="-1"/> °C
Final Value	-1 °C
Humidity Calibration	<input type="checkbox"/>
Illumination Calibration	<input type="checkbox"/>

Besides numerical calibration, ToolBox provides more calibration methods for CO₂:

Manual Calibration: Put the device in an open outdoor environment more than 10 minutes and click this button to calibrate the CO₂ value.

Factory Calibration Restored: Clean the manual calibration and turn back to factory calibration.

CO2 Calibration	<input checked="" type="checkbox"/>
	<input type="button" value="Manual Calibration"/> ?
	<input type="button" value="Factory Calibration Restored"/> ?
Current Raw Value	462 ppm
Calibration Value	<input type="text" value="0"/> ppm
Final Value	462 ppm

4.5.3 Threshold Settings

AM100 series will upload the current data instantly after the threshold is triggered. AM107 will also show alarms of CO₂ and TVOC on the screen.

Go to “**Device Settings->Basic**” of ToolBox software or “**Device->Setting->Threshold Settings**” of ToolBox App to enable the threshold settings and input the threshold.

Threshold Settings ?	
Temperature	<input type="checkbox"/>
CO2	<input checked="" type="checkbox"/>
Over	<input type="text" value="1200"/> ppm
TVOC	<input checked="" type="checkbox"/>
Over	<input type="text" value="400"/> ppb

4.6 Maintenance

4.6.1 Upgrade

ToolBox Software:

1. Download firmware from www.milesight-iot.com to your PC.
2. Go to “**Maintenance -> Upgrade**” of ToolBox software, click “**Browse**” to import firmware and upgrade the device. You can also click “Up to Date” to search for the latest firmware of the device and upgrade.

Maintenance >

Upgrade | Backup and Reset

Model: AM107-915M

Firmware Version: 01.35

Hardware Version: 1.4

Domain: Beijing Server

FOTA: Up to date

Update Locally: [text input field] [Browse] [Upgrade]

ToolBox App:

1. Download firmware from www.milesight-iot.com to your smartphone.
2. Open ToolBox App and click "Browse" to import firmware and upgrade the device.

Note:

- 1) Operation on ToolBox is not supported during the upgrade.
- 2) Only Android version ToolBox supports the upgrade feature.

Status	Setting	Maintenance
SN		6127A2702228
Model		AM104-470M
Firmware Version		V1.40
Hardware Version		V1.0
Manual Upgrade		
<input type="button" value="Browse"/>		

4.6.2 Backup

AM100 devices support configuration backup for easy and quick device configuration in bulk. Backup is allowed only for devices with the same model and LoRa frequency band. Please select one of following methods to backup device:

Via ToolBox Software

Step 1: Go to "Maintenance->Backup and Reset", click "Export" to save current configuration as json format backup file.

Step 2: Click "Browse" to select backup file, then click "Import" to import the configurations.

Upgrade	Backup and Reset
Config Backup	<input type="button" value="Export"/>
Config File	<input type="text"/> <input type="button" value="Browse"/> <input type="button" value="Import"/>
Restore Factory Defaults	<input type="button" value="Reset"/>

Via ToolBox App

Step 1: Go to “Template” page on the App and save current settings as a template. You can also edit the template file.

Step 2: Select one template file which saved in the smartphone and click “Write”, then attach to another device to write configuration.

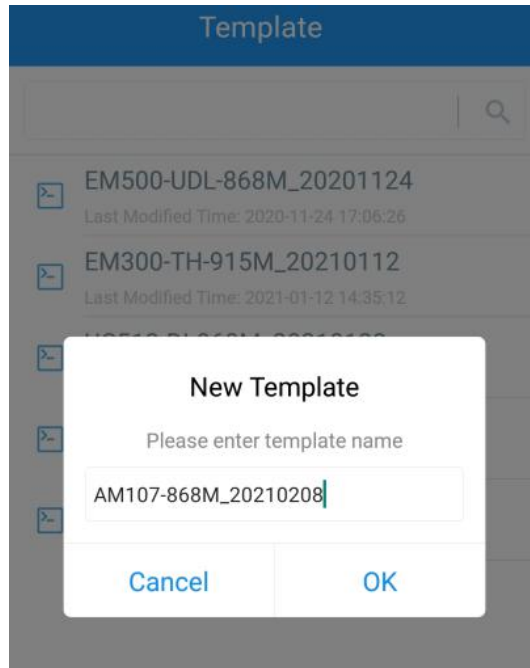

Note: Slide the template item left to edit or delete the template. Click the template to edit the configurations.

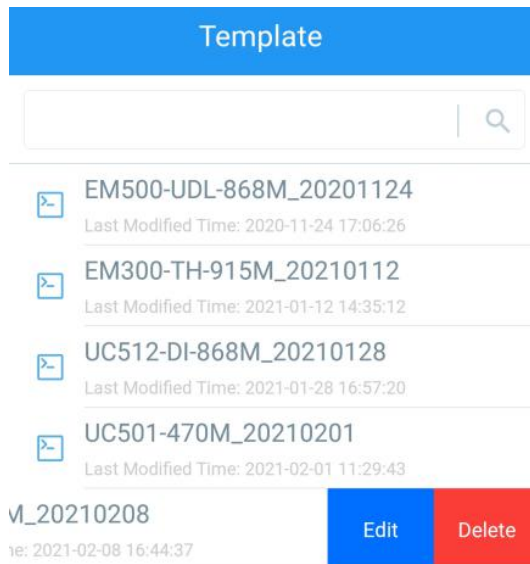

4.6.3 Reset to Factory Default

Please select one of following methods to reset device:

Via Hardware: Hold on power button more than 10s.

Via Toolbox Software: Go to “Maintenance->Backup and Reset” to click “Reset”.

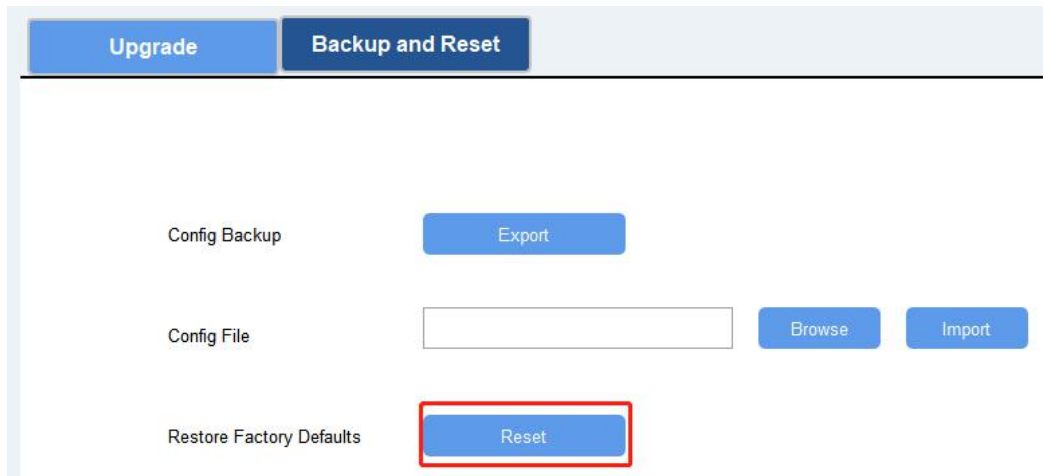

Via Toolbox App: Go to “Device->Maintenance” to click “Reset”, then attach smart phone with NFC area to device to complete reset.

Status	Setting	Maintenance
SN		6127A2702228
Model		AM104-470M
Firmware Version		V1.40
Hardware Version		V1.0
Manual Upgrade		
<input type="button" value="Browse"/>		
Restore Factory Default		
<input type="button" value="Reset"/>		

5. Installation

1. Attach the mounting sticker to the wall.
 2. Drill two mounting holes according to the sticker's mark (around 88mm).
- Note:** The connecting line of two holes must be a horizontal line.
3. Drive the wall plugs and wall mounting screws into wall at the marks using screw driver.
 4. Mount the device on the wall.

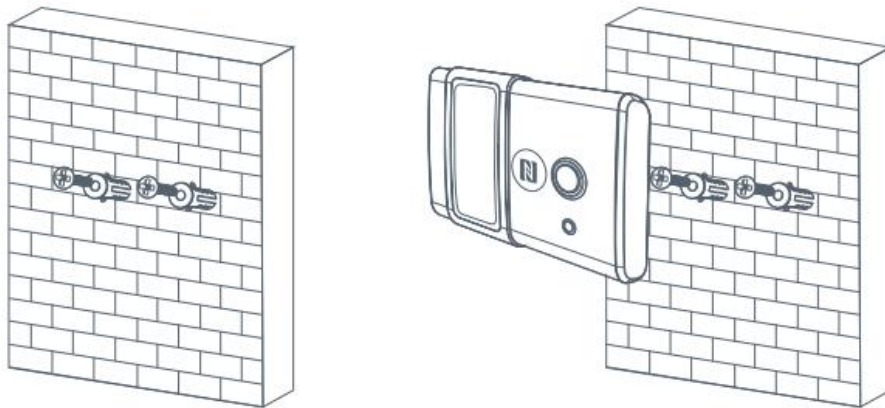
**Note:**

In order to ensure the best detection and LoRaWAN® communication effect, it is recommended to install AM100 series as follows:

- There should not be any isolates or barriers in PIR and light detection range.
- Do not mount the device where the temperature is below/above operating range and temperature varies greatly.
- Stay far away from any heat source or cold source like oven, refrigerator.
- Do not mount the device close to where airflow varies greatly like windows, vent, fan and air conditioner.
- Do not mount the device upside down.
- Do not place the device right to the window or door. If you have to, you'd better pull the curtain.
- It is recommended to install at least 1.5m high from floor.

6. Milesight IoT Cloud Management

AM100 series can be managed by Milesight IoT Cloud platform. Milesight IoT cloud is a comprehensive platform that provides multiple services including device remote management and data visualization with the easiest operation procedures. Please register a Milesight IoT Cloud account before operating following steps.

1. Ensure Milesight LoRaWAN® gateway is online in Milesight IoT Cloud. For more info about connecting gateway to cloud please refer to Gateway User Guide.

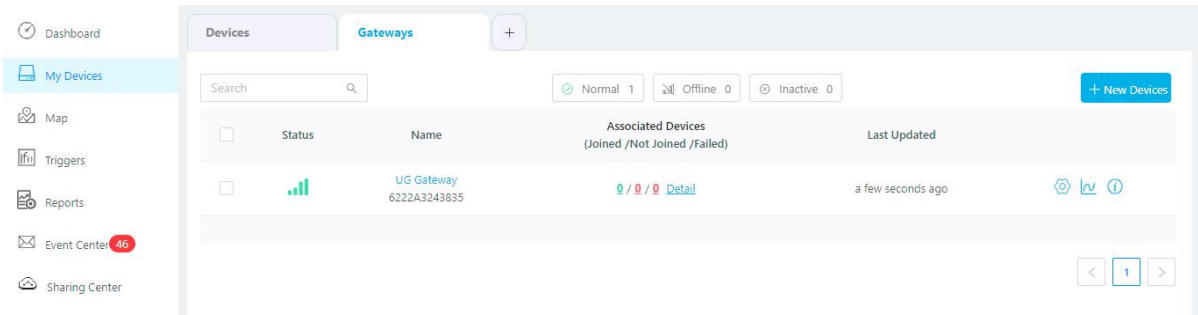

2. Go to “My Devices” page and click “+New Devices”. Fill in the SN of device and select associated gateway.

Add Device ✕

* SN:

* Name:

* Associated Gateway:

* Device EUI:

* Application Key:

3. After the device is online in Milesight IoT Cloud, you can check the data via webpage or mobile App and create dashboard for it.

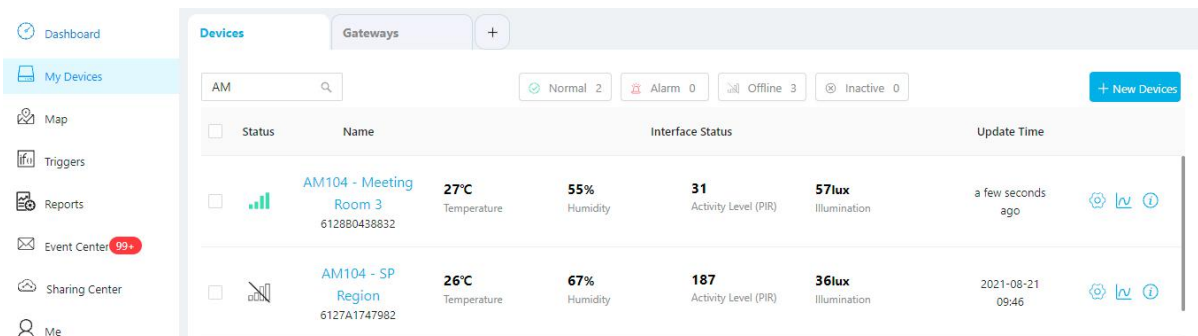

7. Device Payload

All data are based on following format(HEX):

Channel1	Type1	Data1	Channel2	Type2	Data2	Channel 3	...
1 Byte	1 Byte	N Bytes	1 Byte	1 Byte	M Bytes	1 Byte	...

For decoder examples please find files on <https://github.com/Milesight-IoT/SensorDecoders>.

7.1 Basic Information

AM100 series sensors report basic information of sensor everytime joining the network.

Channel	Type	Description
ff	01 (Protocol Version)	01=>V1
	08 (Device SN)	12 digits
	09 (Hardware Version)	01 40 => V1.4
	0a (Software Version)	01 14 => V1.14
	0b (Power On)	Device is on
	0f (Device Type)	00: Class A, 01: Class B, 02: Class C
	18 (Sensor Status)	Byte 0: 00 means all sensors Byte 1: 0=disabled, 1=enabled and every bit means every kind of sensor Bit 0-7: temp, hum, Activity, Light, CO ₂ , TVOC, Pressure

Example:

ff086128a5294269 ff090140 ff0a0142 ff0f00 ff18007b					
Channel	Type	Value	Channel	Type	Value
ff	08 (Device SN)	6128a5294269	ff	09 (Hardware version)	0140 (V1.4)
Channel	Type	Value	Channel	Type	Value
ff	0a (Software version)	0142 (V1.42)	ff	0f (Device Type)	00 (Class A)
Channel	Type	Value			
ff	18 (Sensor Status)	00=>All Sensors 7b=0111 1011 =>Activity level is disabled, and others are enabled			

7.2 Sensor Data

AM100 series sensors report sensor data according to reporting interval (10mins by default).

Battery level is reported **every 24 hours**.

Channel	Type	Description
01	75(Battery Level)	UINT8, Unit: %
03	67 (Temperature)	INT16, Unit: °C, Resolution: 0.1 °C
04	68(Humidity)	UINT8, Unit: %, Resolution: 0.5 %
05	6a(Activity Level)	UINT16
06	65(Illumination)	Byte 1-2: Illumination, Unit: lux Byte 3-4: Visible + Infrared Byte 5-6: Infrared
07	7d (CO ₂)	UINT16, Unit: ppm
08	7d (TVOC)	UINT16, Unit: ppb
09	73 (Barometric Pressure)	UINT16, Unit: hPa, Resolution: 0.1 hPa

Example:

03672901 046861 06651c0079001400 056a8900 077d6704 087dbd00 09734c27					
Channel	Type	Value	Channel	Type	Value
03	67 (Temperature)	29 01 => 01 29 = 297 Temp=297*0.1=2 9.7°C	04	68 (Humidity)	61=>97 Hum=97*0.5 =48.5%
Channel	Type	Value	Channel	Type	Value
06	65 (Illumination)	Illumination: 1c 00 => 00 1c =28 lux Visible + Infrared: 79 00=> 00 79= 121 Infrared: 14 00=> 00 14= 20	05	6a(Activity Level)	89 00 => 00 89 =137
Channel	Type	Value	Channel	Type	Value
07	7d (CO ₂)	67 04 => 04 67 =1127 ppm	08	7d(TVOC)	bd 00 => 00 bd =189 ppb
Channel	Type	Value			
09	73 (Barometric Pressure)	3c 27=>27 3c=10044 Pressure=10044* 0.1=1004.4hPa			

7.3 Downlink Commands

AM100 series sensors support downlink commands to configure the device. The application port is 85 by default.

Channel	Type	Description
ff	03(Set Reporting Interval)	2 Bytes, unit: s
	05(Set Channel Mask)	Byte 1: Channel index range 01: 0-15 02: 16-31 03: 32-47 04: 48-63 05: 64-79 06: 80-95 Byte 2-3: indicate disable or enable via every bit, 0=disable, 1=enable
	10 (Reboot)	ff (Reserved)
	18 (Enable/disable sensor)	Byte 1: Select Sensor 01: Temperature 02: Humidity 03: PIR (Activity) 04: Light 05: CO ₂ 06: TVOC 07: Barometric Pressure Byte 2: 00=disable, 01=enable
	1a(CO ₂ Calibration)	00: Factory Calibration Restored 03: Manual Calibration
	2d (Screen Display)	00: Disable the Display 01: Enable the Display

Example:

1. Set reporting interval as 20 minutes.

ff03b004		
Channel	Type	Value
ff	03 (Set Reporting Interval)	b0 04=>04 b0=1200s =20 minutes

2. Set AU915 or US915 channel mask as 8-15.

ff0501ff00 ff05020000 ff05030000 ff05040000 ff05050000		
Channel	Type	Value
ff	05(Set Channel Mask)	01: Channel index 0-15, ff00=>8-15 is enabled 02-05: Channel index 16-79, 0000=>all disabled

3. Reboot the device.

ff10ff		
Channel	Type	Value
ff	10 (Reboot)	ff (Reserved)

4. Disable temperature and TVOC sensor collection.

ff180100ff180600					
Channel	Type	Value	Channel	Type	Value
ff	18 (Enable/disable sensor)	01=temperature 00=disabled	ff	18 (Enable/disable sensor)	06=TVOC 00=disabled

5. Disable the e-ink screen display.

ff2d00		
Channel	Type	Value
ff	2d (Screen Display)	00: Disable the display

Appendix

Carbon Dioxide Levels and Guidelines

CO ₂ Level	Description
400ppm	Normal outdoor air level.
400-1000ppm	Typical level indoors with good ventilation.
1000-2000ppm	Poor air quality - requires ventilation.
≥2000ppm	Headaches, sleepiness and stagnant, stale, stuffy air. Poor concentration, loss of attention, increased

	heart rate and slight nausea may also be present.
5000ppm	Workplace exposure limit (as 8-hour TWA) in most jurisdictions.
>40000ppm	Exposure may lead to serious oxygen deprivation resulting in permanent brain damage, coma, even death.

-END-