



Industrial Router Pro Series

UR32

User Guide



Preface

Thanks for choosing Milesight UR32 industrial cellular router. The UR32 industrial cellular router delivers tenacious connection over network with full-featured design such as automated failover/failback, extended operating temperature, dual SIM cards, hardware watchdog, VPN, Fast Ethernet and beyond.

This guide describes how to configure and operate the UR32 industrial cellular router. You can refer to it for detailed functionality and router configuration.

Readers

This guide is mainly intended for the following users:

- Network Planners
- On-site technical support and maintenance personnel
- Network administrators responsible for network configuration and maintenance

© 2011-2023 Xiamen Milesight IoT Co., Ltd.

All rights reserved.

All information in this user guide is protected by copyright law. Whereby, no organization or individual shall copy or reproduce the whole or part of this user guide by any means without written authorization from Xiamen Milesight IoT Co., Ltd.

Safety Precautions

Milesight will not shoulder responsibility for any loss or damage resulting from not following the instructions of this operating guide.

- ❖ The device must not be disassembled or remodeled in any way.
- ❖ To avoid risk of fire and electric shock, do keep the product away from rain and moisture before installation.
- ❖ Do not place the device where the temperature or humidity is below/above the operating range.
- ❖ The device must never be subjected to drops, shocks or impacts.
- ❖ Make sure the device is firmly fixed when installing.
- ❖ Make sure the plug is firmly inserted into the power socket.
- ❖ Do not pull the antenna or power supply cable, detach them by holding the connectors.

Declaration of Conformity

UR32 is in conformity with the essential requirements and other relevant provisions of the CE, FCC, and RoHS.



For assistance, please contact

Milesight technical support:

Email: iot.support@milesight.com

Tel: 86-592-5085280

Fax: 86-592-5023065

Address: Building C09, Software Park III,
Xiamen 361024, China

Revision History

Date	Doc Version	Description
May. 16, 2019	V 1.1	Initial version
Nov. 14, 2019	V 1.2	Add Python, SMS, IP passthrough functions
May 11, 2020	V 1.3	Web interfaces upgrade
Dec. 9, 2020	V 2.0	Layout replace
Sept. 17, 2021	V 2.1	<ol style="list-style-type: none"> 1. Cellular and ping detection support IPv6 2. Add WAN connection type: DHCPv6 client, DS-Lite 3. Add DHCPv6 Server feature 4. Add IPv6 static routing feature 5. Add Expert Option box in IPsec settings 6. Support SMS inbox and outbox record clear
June 30, 2023	V 2.2	<ol style="list-style-type: none"> 1. Add high priority link revert feature; 2. Add MQTT and TR069 feature; 3. Support customized cellular MTU and IMS; 4. Support to import openVPN file configurations, add tls-crypt mode and authentication mode; 5. Update Modbus Master/Slave to Modbus Client/Server; 6. Support to configure L2TP hostname.

Contents

Chapter 1 Product Introduction	8
1.1 Overview	8
1.2 Advantages	8
1.3 Specifications	9
1.4 Dimensions (mm)	11
Chapter 2 Access to Web GUI	12
Chapter 3 Web Configuration	13
3.1 Status	13
3.1.1 Overview	13
3.1.2 Cellular	15
3.1.3 Network	16
3.1.4 WLAN (Only Applicable to Wi-Fi Version)	17
3.1.5 VPN	18
3.1.6 Routing	19
3.1.7 Host List	20
3.1.8 GPS (Only Applicable to GPS Version)	21
3.2 Network	22
3.2.1 Interface	22
3.2.1.1 Link Failover	22
3.2.1.2 Cellular	24
3.2.1.3 Port	26
3.2.1.4 WAN	26
3.2.1.5 Bridge	32
3.2.1.6 WLAN (Only Applicable to Wi-Fi Version)	32
3.2.1.7 Switch	35
3.2.1.8 Loopback	35
3.2.2 DHCP	36
3.2.2.1 DHCP Server/DHCPv6 Server	36
3.2.2.2 DHCP Relay	38
3.2.3 Firewall	39
3.2.3.1 Security	39
3.2.3.2 ACL	40
3.2.3.3 Port Mapping (DNAT)	42
3.2.3.4 DMZ	42
3.2.3.5 MAC Binding	43
3.2.3.6 Custom Rules	43
3.2.3.7 SPI	44
3.2.4 QoS	45
3.2.5 VPN	46
3.2.5.1 DMVPN	46

3.2.5.2 IPsec Server	48
3.2.5.3 IPsec	51
3.2.5.4 GRE	54
3.2.5.5 L2TP	55
3.2.5.6 PPTP	58
3.2.5.7 OpenVPN Client	59
3.2.5.8 OpenVPN Server	62
3.2.5.9 Certifications	65
3.2.6 IP Passthrough	66
3.2.7 Routing	67
3.2.7.1 Static Routing	67
3.2.7.2 RIP	68
3.2.7.3 OSPF	71
3.2.7.4 Routing Filtering	76
3.2.8 VRRP	77
3.2.9 DDNS	79
3.3 System	81
3.3.1 General Settings	81
3.3.1.1 General	81
3.3.1.2 System Time	81
3.3.1.3 Email	82
3.3.1.4 Storage	84
3.3.2 Phone&SMS	85
3.3.2.1 Phone	85
3.3.2.2 SMS	86
3.3.3 User Management	87
3.3.3.1 Account	87
3.3.3.2 User Management	88
3.3.4 AAA	88
3.3.4.1 Radius	89
3.3.4.2 TACACS+	89
3.3.4.3 LDAP	90
3.3.4.4 Authentication	91
3.3.5 Device Management	92
3.3.5.1 DeviceHub	92
3.3.5.2 Milesight VPN	93
3.3.6 Events	94
3.3.6.1 Events	94
3.3.6.2 Events Settings	95
3.4 Service	96
3.4.1 I/O	96
3.4.1.1 DI	96
3.4.1.2 DO	97
3.4.2 Serial Port	98

3.4.3 Modbus Server (Slave)	102
3.4.3.1 Modbus TCP	102
3.4.3.2 Modbus RTU	103
3.4.3.3 Modbus RTU Over TCP	103
3.4.4 Modbus Client (Master)	104
3.4.4.1 Modbus Client	104
3.4.4.2 Channel	105
3.4.5 GPS (Only Applicable to GPS Version)	107
3.4.5.1 GPS IP Forwarding	108
3.4.5.2 GPS Serial Forwarding	109
3.4.5.3 GPS MQTT Forward	110
3.4.6 MQTT	110
3.4.7 SNMP	114
3.4.7.1 SNMP	114
3.4.7.2 MIB View	115
3.4.7.3 VACM	115
3.4.7.4 Trap	116
3.4.7.5 MIB	117
3.4.8 TR069	117
3.5 Maintenance	119
3.5.1 Tools	119
3.5.1.1 Ping	119
3.5.1.2 Traceroute	119
3.5.1.3 Packet Analyzer	119
3.5.1.4 Qxdmlog	120
3.5.2 Debugger	120
3.5.2.1 Cellular Debugger	120
3.5.2.2 Firewall Debugger	121
3.5.3 Log	122
3.5.3.1 System Log	122
3.5.3.2 Log Download	123
3.5.3.3 Log Settings	124
3.5.4 Upgrade	125
3.5.5 Backup and Restore	125
3.5.6 Reboot	126
3.6 APP	127
3.6.1 Python	127
3.6.1.1 Python	127
3.6.1.2 App Manager Configuration	127
3.6.1.3 Python App	128
Chapter 4 Application Examples	130
4.1 Network Connection	130
4.1.1 Cellular Connection	130
4.1.2 Ethernet WAN Connection	131

4.2 Wi-Fi Application Example (Only Applicable to Wi-Fi Version)	132
4.2.1 AP Mode	132
4.2.2 Client Mode	133
4.3 OpenVPN Client Application Example	134
4.4 NAT Application Example	136
4.5 DTU Application Example	137
4.6 Restore Factory Defaults	140
4.7 Firmware Upgrade	142
4.8 SNMP Application Example	142
4.9 VRRP Application Example	145
4.10 QoS Application Example	148

Chapter 1 Product Introduction

1.1 Overview

UR32 is an industrial cellular router with embedded intelligent software features that are designed for multifarious M2M/IoT applications. Supporting global WCDMA and 4G LTE, UR32 provides drop-in connectivity for operators and makes a giant leap in maximizing uptime.

Adopting high-performance and low-power consumption industrial grade CPU and wireless module, the UR32 is capable of providing wire-speed network with low power consumption and ultra-small package to ensure the extremely safe and reliable connection to the wireless network.

Meanwhile, the UR32 also supports Fast Ethernet ports, serial port (RS232/RS485) and I/O (input/output), which enables you to scale up M2M application combining data and video in limited time and budget.

UR32 is particularly ideal for smart grid, digital media installations, industrial automation, telemetry equipment, medical device, digital factory, finance, payment device, environment protection, water conservancy and so on.

For details of hardware and installation, please check UR32 Quick Start Guide.

1.2 Advantages

Benefits

- Built-in industrial strong NXP CPU, big memory
- Fast Ethernet for fast data transmission
- Dual SIM cards for backup between multiple carriers networking and global 2G/3G/LTE options make it easy to get connected
- Equipped with Ethernet, I/O, serial port, Wi-Fi, GPS for connecting diverse field assets
- Embedded Python SDK for second development
- Rugged enclosure, optimized for DIN rail or shelf mounting
- 3-year warranty included

Security & Reliability

- Automated failover/failback between Ethernet and Cellular (dual SIM)
- Enable unit with security frameworks like IPsec/OpenVPN/GRE/L2TP/PPTP/ DMVPN
- Embed hardware watchdog, automatically recovering from various failure, and ensuring highest level of availability
- Establish a secured mechanism on centralized authentication and authorization of device access by supporting AAA (TACACS+, Radius, LDAP, local authentication) and multiple levels of user authority

Easy Maintenance

- Milesight DeviceHub provides easy setup, mass configuration, and centralized management of remote devices
- The user-friendly web interface design and more than one option of upgrade help administrator to manage the device as easy as pie
- Web GUI and CLI enable the admin to achieve simple management and quick configuration among a large quantity of devices
- Efficiently manage the remote routers on the existing platform through the industrial standard SNMP and TR069

Capabilities

- Link remote devices in an environment where communication technologies are constantly changing
- Industrial 32-bit ARM Cortex-A7 processor, high-performance operating up to 528MHz and 128 MB memory available to support more applications
- Support rich protocols like SNMP, TR069, MQTT, Modbus bridging, RIP, OSPF
- Support wide operating temperature ranging from -40°C to 70°C/-40°F to 158°F

1.3 Specifications

Hardware System	
CPU	528MHz, 32-bit ARM Cortex-A7
Memory	128 MB Flash, 128 MB DDR3 RAM
Storage	1 × Micro SD
Cellular Interfaces	
Connectors	2 × 50 Ω SMA (Center pin: SMA Female)
SIM Slots	2
Wi-Fi Interface (Optional)	
Connectors	1 × 50 Ω SMA (Center pin: RP-SMA Female)
Standards	IEEE 802.11 b/g/n
Tx Power	802.11b: 16 dBm +/-1.5 dBm (11 Mbps)
	802.11g: 14 dBm +/-1.5 dBm (54 Mbps)
	802.11n: 13 dBm +/-1.5 dBm (65 Mbps, HT20/40 MCS7)
Modes	Support AP and Client mode, multiple SSID
Security	WPA/WPA2 authentication, WEP/TKIP/AES encryption

GPS (Optional)	
Connectors	1 × 50 Ω SMA (Center pin: SMA Female)
Protocols	NMEA 0183, PMTK
Ethernet	
Ports	2 × RJ-45 (PoE PSE Optional)
Physical Layer	10/100 Base-T (IEEE 802.3)
Data Rate	10/100 Mbps (auto-sensing)
Interface	Auto MDI/MDIX
Mode	Full or half duplex (auto-sensing)
Serial Interface	
Ports	1 × RS232 (RS485 Hardware Optional)
Connector	Terminal block
Baud Rate	300bps to 230400bps
IO	
Connector	Terminal block
Digital	1 × DI + 1 × DO
Software	
Network Protocols	IPv4/IPv6, PPP, PPPoE, SNMP v1/v2c/v3, TCP, UDP, DHCP, RIPv1/v2, OSPF, DDNS, VRRP, HTTP, HTTPS, DNS, ARP, QoS, SNTP, Telnet, VLAN, SSH, MQTT, TR069, etc.
VPN Tunnel	DMVPN/IPsec/OpenVPN/PPTP/L2TP/GRE
Access Authentication	CHAP/PAP/MS-CHAP/MS-CHAPV2
Firewall	ACL/DMZ/Port Mapping/MAC Binding/SPI/DoS&DDoS Protection /IP Passthrough
Management	Web, CLI, SMS, On-demand dial up, DeviceHub
AAA	Radius, TACACS+, LDAP, Local Authentication
Multilevel Authority	Multiple levels of user authority
Reliability	VRRP, WAN Failover, Dual SIM Backup
Serial Port	Transparent (TCP Client/Server, UDP), Modbus Gateway (Modbus RTU to Modbus TCP)
Power Supply and Consumption	
Connector	2-pin with 5.08 mm terminal block
Input Voltage	9-48 VDC
Power Consumption	Typical 1.9 W, Max 2.4 W (In Non-PoE mode)

Power Output (Optional) 2 × 802.3 af/at PoE output

Physical Characteristics

Ingress Protection IP30

Housing & Weight Metal, 271 g

Dimensions 108 x 90 x 26 mm (4.25 x 3.54 x 1.02 in)

Mounting Desktop, wall or DIN rail mounting

Others

Reset Button 1 × RESET

LED Indicators 1 × POWER, 1 × SYSTEM, 1 × SIM, 3 × Signal strength

Built-in Watchdog, Timer

Environmental

Operating Temperature -40°C to +70°C (-40°F to +158°F)
Reduced cellular performance above 60°C

Storage Temperature -40°C to +85°C (-40°F to +185°F)

Ethernet Isolation 1.5 kV RMS

Relative Humidity 0% to 95% (non-condensing) at 25°C/77°F

1.4 Dimensions (mm)

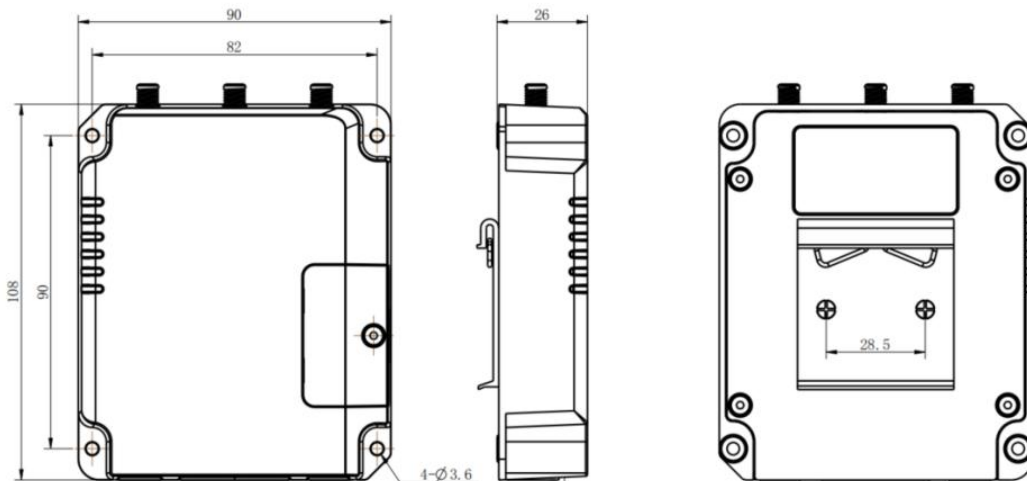

Chapter 2 Access to Web GUI

This chapter explains how to access to Web GUI of the UR32 router. Connect PC to LAN port of UR32 router directly. The following steps are based on Windows 10 operating system for your reference.

Username: **admin**

Password: **password**

IP Address: **192.168.1.1**

1. Go to "Control Panel" → "Network and Internet" → "Network and Sharing Center", then click "Ethernet" (May have different names).

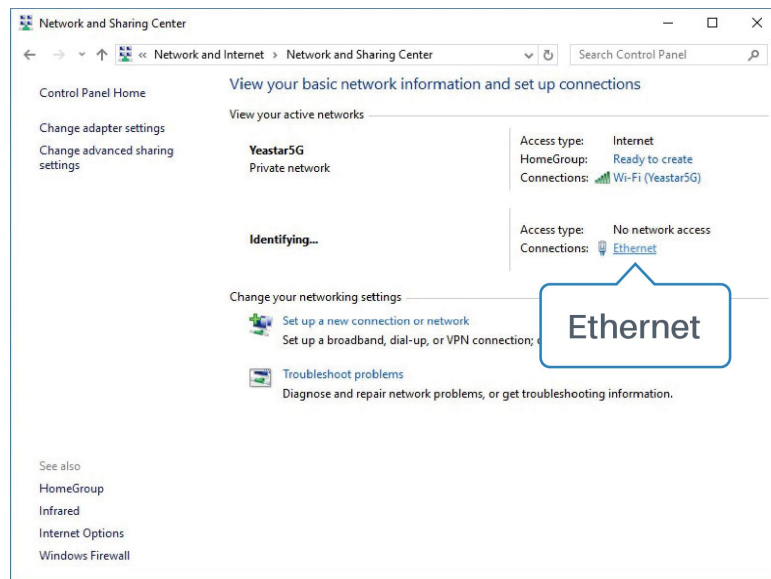

2. Go to "Properties" → "Internet Protocol Version 4(TCP/IPv4) ", select "Obtain an IP address automatically" or "Use the following IP address", then assign a static IP manually within the same subnet of the device.

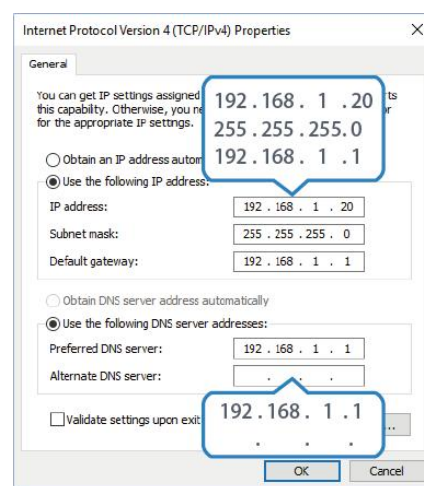
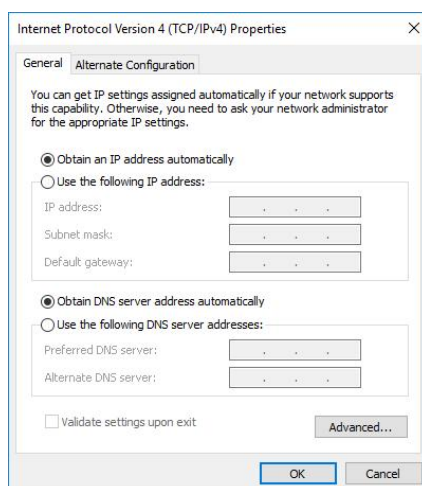

3. Open a Web browser on your PC (Chrome is recommended), type in the IP address 192.168.1.1, and press Enter on your keyboard.
4. Enter the username, password, and click "Login".

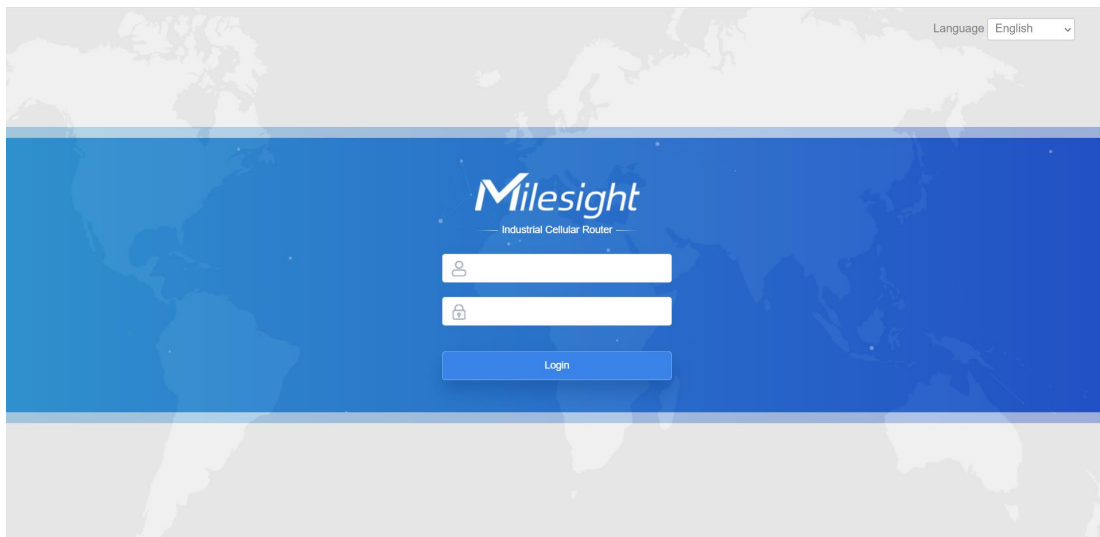

⚠ If you enter the username or password incorrectly more than 5 times, the login page will be locked for 10 minutes.

5. When you login with the default username and password, you will be asked to modify the password. It's suggested that you change the password for the sake of security. Click "Cancel" button if you want to modify it later.

Old Password	<input type="password"/>
New Password	<input type="password"/>
Confirm New Password	<input type="password"/>

6. After you login the Web GUI, you can view system information and perform configuration on the router.

Chapter 3 Web Configuration

3.1 Status

3.1.1 Overview

You can view the system information of the router on this page.

System Information		System Status	
Model	UR32-L00E-G-W-485	Local Time	2023-06-30 19:21:33 Friday
Serial Number	621892434471	Uptime	15days, 04:18:43
Firmware Version	32.3.0.7	CPU Load	52%
Hardware Version	V1.1	CPU Temperature	66°C
		RAM (Available/Capacity)	24MB/128MB(18.75%)
		Flash (Available/Capacity)	81MB/128MB(63.28%)
		SD Card(Available/Capacity)	Not Inserted
Cellular		WAN ● Link in use	
Status	No SIM Card	Status	Online
Current SIM	SIM2	IPv4	192.168.40.166/24
IPv4	0.0.0.0/0	IPv6	fe80::26e1:24ff:fe0b:6443/64
IPv6	-	MAC	24:e1:24:0b:64:45
Connection Duration	0 days, 00:00:00	Connection Duration	1 days, 11:38:04
Data Usage Monthly	0.0 MiB		
WLAN		LAN	
Status	Running	IPv4	192.168.10.1/24
Mode	AP	IPv6	fe80::1cc8:50ff:fe17:d146/64
SSID	Router_0B6444	Connected Devices	2
Connected Clients	0		

Figure 3-1-1-1

System Information	
Item	Description
Model	Show the model name of router.
Serial Number	Show the serial number of router.
Firmware Version	Show the currently firmware version of router.
Hardware Version	Show the currently hardware version of router.

Table 3-1-1-1 System Information

System Status	
Item	Description
Local Time	Show the currently local time of system.
Uptime	Show the information on how long the router has been running.
CPU Load	Show the current CPU utilization of the router.
CPU Temperature	Show current CPU temperature.
RAM (Available/Capacity)	Show the RAM capacity and the available RAM memory.
Flash (Available/Capacity)	Show the Flash capacity and the available Flash memory.
SD Card (Available/Capacity)	Show the capacity and the available memory of micro SD card if it is inserted.

Table 3-1-1-2 System Status

Cellular	
Item	Description
Status	Show the real-time status of the currently SIM card
Current SIM	Show the SIM card currently used for the data connection.

IPv4/IPv6	Show the IPv4/IPv6 address obtained from the mobile carrier.
Connection Duration	Show the connection duration of the currently SIM card.
Data Usage Monthly	Show the monthly data usage statistics of currently used SIM card.

Table 3-1-1-3 Cellular Status

WAN	
Item	Description
Status	Show the currently status of WAN port.
IPv4/IPv6	The IPv4/IPv6 address configured WAN port.
MAC	The MAC address of the Ethernet port.
Connection Duration	Show the connection duration of the WAN port.

Table 3-1-1-4 WAN Status

WLAN (Only applicable for Wi-Fi model)	
Item	Description
Status	Show the currently status of WLAN.
IP	Show the WLAN mode (AP or client).
SSID	Show the SSID of the WLAN AP or client.
Connected Clients	Show the amount of connected devices when mode is AP.

Table 3-1-1-5 WLAN Status

LAN	
Item	Description
IP4/IPv6	Show the IP4/IPv6 address of the LAN port.
Connected Devices	Number of devices that connected to the router's LAN.

Table 3-1-1-6 LAN Status

3.1.2 Cellular

You can view the cellular network status of router on this page.

Modem		Network	
Model	EC20F	Status	Connected
Version	EC20CEHCLGR06A05M1G	IPv4 Address	10.171.227.152/28
Current SIM	SIM1	IPv4 Gateway	10.171.227.153
Signal Level	31asu (-51dBm)	IPv4 DNS	211.143.147.120
Register Status	Registered (Home network)	IPv6 Address	2409:8934:1a1e:ca08:9c3f:1718:6fcd:4ad3/64
IMEI	861942056289607	IPv6 Gateway	2409:8934:1a1e:ca08:8e7:5c15:e8dd:111
IMSI	460005970144200	IPv6 DNS	2409:8034:2000:0:0:0:0:4
ICCID	898600511318F2001679	Connection Duration	0 days, 02:32:02
ISP	CHINA MOBILE	Data Usage Monthly	
Network Type	TDD LTE	SIM-1	RX: 0.0 MIB TX: 0.0 MIB ALL: 0.0 MIB
PLMN ID	46000	SIM-2	RX: 0.0 MIB TX: 0.0 MIB ALL: 0.0 MIB
LAC	592f		
Cell ID	3d98485		

Figure 3-1-2-1

Modem Information

Item	Description
Status	Show corresponding detection status of module and SIM card.
Version	Show the cellular module firmware version.
Current SIM	Show the current SIM card used.
Signal Level	Show the cellular signal level.
Register Status	Show the registration status of SIM card.
IMEI	Show the IMEI of the module.
IMSI	Show IMSI of the SIM card.
ICCID	Show ICCID of the SIM card.
ISP	Show the network provider which the SIM card registers on.
Network Type	Show the connected network type, such as LTE, 3G, etc.
PLMN ID	Show the current PLMN ID, including MCC, MNC, LAC and Cell ID.
LAC	Show the location area code of the SIM card.
Cell ID	Show the Cell ID of the SIM card location.

Table 3-1-2-1 Modem Information

Network	
Item	Description
Status	Show the connection status of cellular network.
IPv4/IPv6 Address	Show the IPv4/IPv6 address and netmask of cellular network.
IPv4/IPv6 Gateway	Show the IPv4/IPv6 gateway and netmask of cellular network.
IPv4/IPv6 DNS	Show the IPv4/IPv6 DNS of cellular network.
Connection Duration	Show information on how long the cellular network has been connected.

Table 3-1-2-2 Network Status

Data Usage Monthly	
Item	Description
SIM-1	Show the monthly data usage statistics of SIM-1.
SIM-2	Show the monthly data usage statistics of SIM-2.

Table 3-1-2-3 Data Usage Information

3.1.3 Network

On this page you can check the WAN and LAN status of the router.

WAN-IPv4						
Port	Status	Type	IPv4	Gateway	DNS	Connection Duration
LAN1/WAN	up	Static	192.168.22.210/24	192.168.22.1	114.114.114.114	08h 32m 53s
WAN-IPv6						
Port	Status	Type	IPv6	Gateway	DNS	Connection Duration
LAN1/WAN	up	Static	fe80::26e1:24ff:fe11:2fea/64	-	-	08h 32m 53s

Figure 3-1-3-1

WAN Status	
Item	Description

Port	Show the name of WAN port.
Status	Show the status of WAN port. "up" refers to a status that WAN is enabled and Ethernet cable is connected. "down" means Ethernet cable is disconnected or WAN function is disabled.
Type	Show the dial-up connection type of WAN port.
IPv4/IPv6	Show the IPv4 address with netmask or IPv6 address with prefix-length of WAN port.
Gateway	Show the gateway of WAN port.
DNS	Show the DNS of WAN port.
Connection Duration	Show the information on how long the Ethernet cable has been connected on WAN port when WAN function is enabled. Once WAN function is disabled or Ethernet connection is disconnected, the duration will stop.

Table 3-1-3-1 WAN Status

Bridge				
Name	STP	IPv4	IPv6	Members
Bridge0	Disabled	192.168.219.1/24	7878::1/64	vlan 1,WLAN

Figure 3-1-3-2

Bridge	
Item	Description
Name	Show the name of the bridge interface.
STP	Show if STP is enabled.
IPv4/IPv6	Show the IPv4/IPv6 address and netmask of the bridge interface.
Netmask	Show the Netmask of the bridge interface.
Members	Show the members of the bridge interface.

Table 3-1-3-2 Bridge Status

3.1.4 WLAN (Only Applicable to Wi-Fi Version)

You can check Wi-Fi status on this page, including the information of access point and client.

WLAN Status						
Name	Status	Type	SSID	IP Address	Netmask	
WLAN	Running	AP	Router_F02FEB	192.168.1.1	255.255.255.0	

Associated Stations			
SSID	MAC Address	IP Address	Connection Duration

Figure 3-1-4-1

WLAN Status	
Item	Description

WLAN Status	
Name	Show the name of the Wi-Fi interface .
Status	Show the status of the Wi-Fi interface.
Type	Show the Wi-Fi interface type.
SSID	Show the SSID of the router when the interface type is AP. Show the SSID of AP which the router connected to when the interface type is Client.
IP Address	Show the IP address of the router when the interface type is AP. Show the IP address of AP which the router connected to when the interface type is Client.
Netmask	Show the netmask of the router when the interface type is AP. Show the netmask of AP which the router connected to when the interface type is Client.
Associated Stations	
SSID	Show the SSID of the router when the interface type is AP. Show the SSID of AP which the router connected to when the interface type is Client.
MAC Address	Show the MAC address of the client which connected to the router when the interface type is AP. Show the MAC address of the AP which the router connected to when the interface type is Client.
IP Address	Show the IP address of the client which connected to the router when the interface type is AP. Show the IP address of the AP which the router connected to when the interface type is Client.
Connection Duration	Show the connection duration between client device and router when the interface type is AP. Show the connection duration between router and the AP when the interface type is Client.

Table 3-1-4-1 WLAN Status

3.1.5 VPN

You can check VPN status on this page, including PPTP, L2TP, IPsec, OpenVPN and DMVPN.

Clients			
Name	Status	Local IP	Remote IP
Server			
Name		Status	
OpenVPN Server		Disabled	
Ipsec Server		Disabled	
Connected List			
Server Type	Client IP	Duration	

Figure 3-1-5-1

VPN Status	
Item	Description
Clients	
Name	Show the name of the enabled VPN clients.
Status	Show the status of client. "Connected" refers to a status that client is connected to the server. "Disconnected" means client is disconnected to the server.
Local IP	Show the local IP address of the tunnel.
Remote IP	Show the real remote IP address of the tunnel.
Server	
Name	Show the name of the enabled VPN Server.
Status	Show the status of Server.
Connected List	
Server Type	Show the type of the server.
Client IP	Show the IP address of the client which connected to the server.
Duration	Show the information about how long the client has been connected to this server when the server is enabled. Once the server is disabled or connection is disconnected, the duration will stop counting.

Table 3-1-5-1 VPN Status

3.1.6 Routing

You can check routing status on this page, including the routing table and ARP cache.

Routing Table					
Destination	Netmask/Prefix Length	Gateway	Interface	Metric	
0.0.0.0	0.0.0.0	192.168.40.1	LAN1/WAN	1	
8.8.8.8	255.255.255.255	192.168.40.1	LAN1/WAN	1	
114.114.114.114	255.255.255.255	192.168.40.1	LAN1/WAN	1	
127.0.0.0	255.0.0.0	-	Loopback	-	
192.168.2.0	255.255.255.0	-	vlan2	-	
192.168.3.0	255.255.255.0	-	vlan3	-	
192.168.10.0	255.255.255.0	-	Bridge0	-	
192.168.40.0	255.255.255.0	-	LAN1/WAN	-	
::1	128	-	Loopback	-	

ARP Cache			
IP	MAC	Interface	
192.168.10.101	00:00:00:00:00:00	Bridge0	
192.168.40.201	24:e1:24:f6:64:2f	LAN1/WAN	
192.168.40.9	08:00:27:0a:1a:21	LAN1/WAN	
192.168.40.35	58:11:22:92:f8:c4	LAN1/WAN	
8.8.8.8	00:00:00:00:00:00	LAN1/WAN	
192.168.40.41	50:eb:f6:9f:aa:60	LAN1/WAN	

Figure 3-1-6-1

Item	Description
Routing Table	
Destination	Show the IP address of destination host or destination network.
Netmask/Prefix Length	Show the netmask or prefix length of destination host or destination network.
Gateway	Show the IP address of the gateway.
Interface	Show the outbound interface of the route.
Metric	Show the metric of the route.
ARP Cache	
IP	Show the IP address of ARP pool.
MAC	Show the IP address's corresponding MAC address.
Interface	Show the binding interface of ARP.

Table 3-1-6-1 Routing Information

3.1.7 Host List

You can view the host information on this page.

DHCP Leases		
IP	MAC/DUID	Lease Remaining Time
192.168.1.113	c8:5b:76:b2:56:1f	23h 07m 24s
2004:200	00:01:00:01:27:cc:cf:61:c8:5b:76:b2:56:1f	23h 09m 22s

MAC Binding	
IP	MAC/DUID

Figure 3-1-7-1

Host List	
Item	Description
DHCP Leases	
IP Address	Show IP address of DHCP client
MAC/DUID	Show MAC address of DHCPv4 client or DUID of DHCPv6 client.
Lease Time Remaining	Show the remaining lease time of DHCP client.
MAC Binding	
IP & MAC	Show the IP address and MAC address set in the Static IP list of DHCP service.

Table 3-1-7-1 Host List Description

3.1.8 GPS (Only Applicable to GPS Version)

When GPS function is enabled and the GPS information is obtained successfully, you can view the latest GPS information including GPS Time, Latitude, Longitude and Speed on this page.

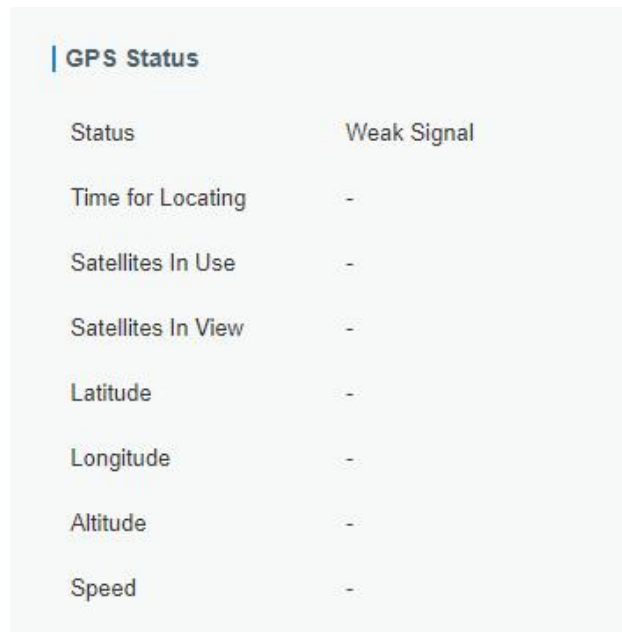

GPS Status	
Status	Weak Signal
Time for Locating	-
Satellites In Use	-
Satellites In View	-
Latitude	-
Longitude	-
Altitude	-
Speed	-

Figure 3-1-8-1

GPS Status	
Item	Description
Status	Show the status of GPS.
Time for Locating	Show the time for locating.
Satellites In Use	Show the quantity of satellites in use.
Satellites In View	Show the quantity of satellites in view.
Latitude	Show the Latitude of the location.
Longitude	Show the Longitude of the location.
Altitude	Show the Altitude of the location.
Speed	Show the speed of movement.

Table 3-1-8-1 GPS Status Description

3.2 Network

3.2.1 Interface

3.2.1.1 Link Failover

This section describes how to configure link failover strategies, their priority and the ping settings, each rule owns its own ping rules by default. Router will follow the priority to choose the next available interface to access the internet, make sure you have enable the full interface that you need to use here. If priority 1 can only use IPv4, UR32 will select a second link which IPv6 works as main IPv6 link and vice versa.

The screenshot shows the 'Link Failover' configuration page. At the top, there are tabs for 'Cellular', 'Port', 'WAN', 'Bridge', 'Switch', and 'Loopback'. The 'Link Priority' section contains a table with the following data:

Priority	Enable Rule	Link in use	Interface	Connection Type	IP	Operation
1	<input checked="" type="checkbox"/>	●	Cellular-SIM1	DHCP	10.53.62.91	[Edit] [Up] [Down]
2	<input checked="" type="checkbox"/>	●	WAN	Static	192.168.40.151	[Edit] [Up] [Down]
3	<input checked="" type="checkbox"/>	●	Cellular-SIM2	DHCP	-	[Edit] [Up] [Down]

The 'Settings' section includes the following options:

- Revert to High Priority Link:
- Revert Interval: s
- Dual-card Switch Delay: s
- Dual-card Recovery Interval: min
- Emergency Reboot:

Figure 3-2-1-1

Link Failover	
Item	Description
Link Priority	
Priority	Display the priority of each interface, you can modify it by the operation's up and down button.
Enable Rule	If enabled, the router will put this interface into its switching rule. For the Cellular interface, if it's not enabled here, the interface will be disabled as well.
Link In Use	Mark whether this interface is in use with Green color
Interface	Display the name of the interface.
Connection type	Display how to obtain the IP address in this interface, like static IP or DHCP.
IP	Display the IP address of the interface.
Operation	You can change the priority of the rules and configure the ping detection rules here.
Settings	
Revert to High Priority Link	When the connection of high priority link returns back, reverting back to high priority link.
Revert Interval	Specify the number of seconds to waiting for switching to the

	link with higher priority, 0 means disable the function.
Dual-card Switch Delay	The delay time to switch to low priority card when high priority cellular connection is failed. 0 means switching immediately.
Dual-card Recovery Interval	The interval to detect high priority cellular connection. If the connection is recover, switching back to high priority cellular link.
Emergency Reboot	Enable to reboot the device if no link is available.

Table 3-2-1-1 Link Failover Parameters

Figure 3-2-1-2

Ping Detection	
Item	Description
Enable	If enabled, the router will periodically detect the connection status of the link.
IPv4/IPv6 Primary Server	The router will send ICMP packet to the IPv4/IPv6 address or hostname to determine whether the Internet connection is still available or not.
IPv4/IPv6 Secondary Server	The router will try to ping the secondary server name if primary server is not available.
Interval	Time interval (in seconds) between two Pings.
Retry Interval	Set the ping retry interval. When ping failed, the router will ping again in every retry interval.
Timeout	The maximum amount of time the router will wait for a response to a ping request. If it does not receive a response for the amount of time defined in this field, the ping request will be considered to have failed.
Max Ping Retries	The retry times of the router sending ping request until determining that the connection has failed.

Table 3-2-1-2 Ping Detection Parameters

3.2.1.2 Cellular

This section explains how to set the related parameters for cellular network. The UR32 cellular router has two cellular interfaces, namely SIM1 and SIM2. Only one cellular interface is active at one time. If both cellular interfaces are enabled, it will follow the priority rule configured in Link Failover page.

	SIM1	SIM2
Protocol Type	IPv4	IPv4
APN		
Username		
Password		
PIN Code
Access Number		
Authentication Type	None	None
Network Type	Auto	Auto
PPP Preferred	<input type="checkbox"/>	<input type="checkbox"/>
IMS Enable	<input type="checkbox"/>	<input checked="" type="checkbox"/>
SMS Center		
Enable NAT	<input checked="" type="checkbox"/>	<input checked="" type="checkbox"/>
Roaming	<input checked="" type="checkbox"/>	<input checked="" type="checkbox"/>
Customize MTU	<input type="checkbox"/>	<input type="checkbox"/>
MTU	1500	1500
Data Limit	0 MB	0 MB
Billing Day	Day 1 of The Month	Day 1 of The Month

Figure 3-2-1-3

Cellular Settings	
Item	Description
Protocol Type	Select from "IPv4", "IPv6" and "IPv4/IPv6".
APN	Enter the Access Point Name for cellular dial-up connection provided by local ISP.
Username	Enter the username for cellular dial-up connection provided by local ISP.
Password	Enter the password for cellular dial-up connection provided by local ISP.
PIN Code	Enter a 4-8 characters PIN code to unlock the SIM.
Access Number	Enter the dial-up center NO. For cellular dial-up connection provided by local ISP.
Authentication Type	Select from "None", "PAP", "CHAP", "MS-CHAP", and "MS-CHAPv2".
Network Type	Select from "Auto", "4G Only", "3G Only", and "2G Only". Auto: connect to the network with the strongest signal automatically. 4G Only: connect to 4G network only.

	And so on.
PPP Preferred	The PPP dial-up method is preferred.
IMS Enable	Enable or disable IMS function.
SMS Center	Enter the local SMS center number for storing, forwarding, converting and delivering SMS message.
Enable NAT	Enable or disable NAT function.
Roaming	Enable or disable roaming.
Customize MTU	Enable or disable to customize the maximum transmission units. When disabled, the device will use operator's MTU settings.
MTU	Customize the maximum transmission units.
Data Limit	When you reach the specified data usage limit, the data connection of currently used SIM card will be disabled. 0 means disable the function.
Billing Day	Choose the billing day of the SIM card, the router will reset the data used to 0.

Table 3-2-1-3 Cellular Parameters

Connection Setting

Connection Mode: Connect on Demand

Re-dial Interval(s): 5

Max Idle Time(s): 60

Triggered by Call:

Call Group: [Empty dropdown]

Triggered by SMS:

SMS Group: [Empty dropdown]

SMS Text: [Empty text box]

Triggered by IO:

Figure 3-2-1-4

Connection Setting	
Item	Description
Connection Mode	Select from "Always Online" and "Connect on Demand".
Re-dial Interval(s)	Set the interval to dial into ISP when it lost connection, the default value is 5s.
Max Idle Times	Set the maximum duration of router when current link is under idle status. Range: 10-3600
Triggered by Call	The router will switch from offline mode to cellular network mode automatically when it receives a call from the specific phone number.
Call Group	Select a call group for call trigger. Go to "System > Phone&SMS > Phone" to set up phone group.
Triggered by SMS	The router will switch from offline mode to cellular network mode automatically when it receives a specific SMS from the specific mobile phone.

SMS Group	Select an SMS group for trigger. Go to "System > Phone&SMS > SMS" to set up SMS group.
SMS Text	Fill in the SMS content for triggering.
Triggered by IO	The router will switch from offline mode to cellular network mode automatically when the DI status is changed. Go to "Industrial > I/O > DI" to configure trigger condition.

Table 3-2-1-4 Cellular Parameters

Related Topics

[Cellular Network Connection](#)

[Phone Group](#)

[DI Setting](#)

3.2.1.3 Port

This section describes how to configure the Ethernet port parameters.

UR32 cellular router supports 2 Fast Ethernet ports.

Port	Status	Property	Speed	Duplex
LAN1/WAN	up	wan	auto	auto
LAN2	up	lan	auto	auto

Figure 3-2-1-5

Port Setting	
Item	Description
Port	Users can define the Ethernet ports according to their needs.
Status	Set the status of Ethernet port; select "up" to enable and "down" to disable.
Property	Show the Ethernet port's type, as a WAN port or a LAN port.
Speed	Set the Ethernet port's speed. The options are "auto", "100 Mbps", and "10 Mbps".
Duplex	Set the Ethernet port's mode. The options are "auto", "full", and "half".

Table 3-2-1-5 Port Parameters

3.2.1.4 WAN

WAN port can be connected with Ethernet cable to get Internet access.

WAN Settings

— WAN_1

Enable	<input checked="" type="checkbox"/>
Port	LAN1/WAN
Connection Type	Static IP
IPv4 Address	192.168.40.166
Netmask	255.255.255.0
IPv4 Gateway	192.168.40.1
IPv6 Address	fe80::26e1:24ff:fe0b:6443
Prefix Length	64
IPv6 Gateway	
MTU	1500
IPv4 Primary DNS	8.8.8.8
IPv4 Secondary DNS	
IPv6 Primary DNS	
IPv6 Secondary DNS	
Enable NAT	<input checked="" type="checkbox"/>

Figure 3-2-1-6

WAN Setting		
Item	Description	Default
Enable	Enable WAN function.	Enable
Port	The port that is currently set as WAN port.	WAN
Connection Type	Select connection type as required. Static IP: assign a static IP address, netmask and gateway for Ethernet WAN interface. DHCP Client: configure Ethernet WAN interface as DHCP Client to obtain IP address automatically. PPPoE: configure Ethernet WAN interface as PPPoE Client. -DHCPv6 Client: configure Ethernet WAN interface as DHCP Client to obtain IPv6 address automatically.	Static IP

	Dual-Stack Lite: use IPv4-in-IPv6 tunneling to send terminal device's IPv4 packet through a tunnel on the IPv6 access network to the ISP.	
MTU	Set the maximum transmission unit.	1500
IPv4 Primary DNS	Set the primary IPv4 DNS server.	8.8.8.8
IPv4 Secondary DNS	Set the secondary IPv4 DNS server.	-- --
IPv6 Primary DNS	Set the primary IPv6 DNS server.	-- --
IPv6 Secondary DNS	Set the secondary IPv6 DNS server.	-- --
Enable NAT	Enable or disable NAT function. When enabled, a private IP can be translated to a public IP.	Enable

Table 3-2-1-6 WAN Parameters

1. Static IP Configuration

If the external network assigns a fixed IP for the WAN interface, select Static IP mode.

Enable

Port

Connection Type

IPv4 Address

Netmask

IPv4 Gateway

IPv6 Address

Prefix Length

IPv6 Gateway

MTU

IPv4 Primary DNS

IPv4 Secondary DNS

IPv6 Primary DNS

IPv6 Secondary DNS

Enable NAT

Multiple IP Address

IP Address	Netmask	Operation
		<input type="button" value="+"/>

Figure 3-2-1-7

Static IP		
Item	Description	Default
IPv4 Address	Set the IPv4 address of the WAN port.	192.168.0.1

Netmask	Set the Netmask for WAN port.	255.255.255.0
IPv4 Gateway	Set the gateway for WAN port's IPv4 address.	192.168.0.2
IPv6 Address	Set the IPv6 address which can access Internet.	Generated from Mac address
Prefix-length	Set the IPv6 prefix length to identify how many bits of a Global Unicast IPv6 address are there in network part. For example, in 2001:0DB8:0000:000b::/64, the number 64 is used to identify that the first 64 bits are in network part.	64
IPv6 Gateway	Set the gateway for WAN port's IPv6 address. E.g.2001:DB8:ACAD:4::2.	--
Multiple IP Address	Set the multiple IP addresses for WAN port.	Null

Table 3-2-1-7 Static Parameters

2. DHCP Client/DHCPv6 Client

If the external network has DHCP server enabled and has assigned IP addresses to the Ethernet WAN interface, select DHCP/DHCPv6 client mode to obtain IP address automatically.

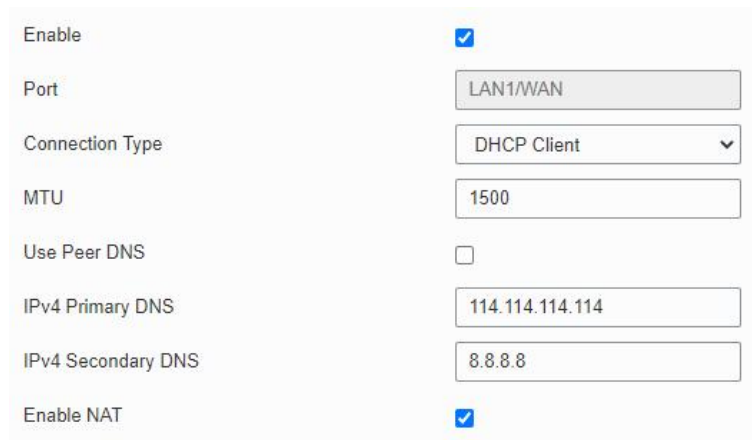

Enable

Port

Connection Type

MTU

Use Peer DNS

IPv4 Primary DNS

IPv4 Secondary DNS

Enable NAT

Figure 3-2-1-8

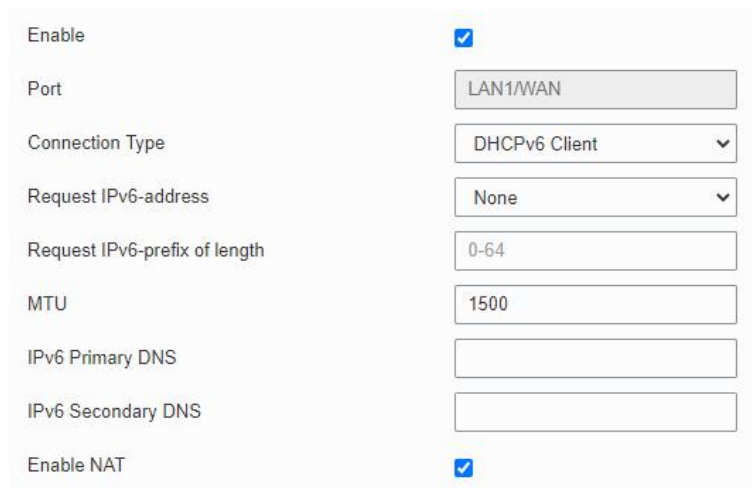

Enable

Port

Connection Type

Request IPv6-address

Request IPv6-prefix of length

MTU

IPv6 Primary DNS

IPv6 Secondary DNS

Enable NAT

Figure 3-2-1-9

DHCP Client	
Item	Description
Use Peer DNS	Obtain peer DNS automatically during PPP dialing. DNS is necessary when visiting domain name.
DHCPv6 Client	
Request IPv6-address	Choose the ways to obtain the IPv6 address from the DHCP Server. Select from try, force, none. Try: The DHCP Server will assign specific address in priority. Force: The DHCP Server assigns specific address only. None: The DHCP Server will randomly assign address. The specific address is relevant to the prefix length of IPv6 address you set.
Request prefix length of IPv6	Set the prefix length of IPv6 address which router is expected to obtain from DHCP Server.

Table 3-2-1-8 DHCP Client Parameters

3. PPPoE

PPPoE refers to a point to point protocol over Ethernet. User has to install a PPPoE client on the basis of original connection way. With PPPoE, remote access devices can get control of each user.

Enable	<input checked="" type="checkbox"/>
Port	LAN1/WAN
Connection Type	PPPoE
Username	<input type="text"/>
Password	<input type="text"/>
Link Detection Interval(s)	60
Max Retries	0
MTU	1500
Use Peer DNS	<input type="checkbox"/>
IPv4 Primary DNS	114.114.114.114
IPv4 Secondary DNS	8.8.8.8
Enable NAT	<input checked="" type="checkbox"/>

Figure 3-2-1-10

PPPoE	
Item	Description
Username	Enter the username provided by your Internet Service Provider (ISP).

Password	Enter the password provided by your Internet Service Provider (ISP).
Link Detection Interval (s)	Set the heartbeat interval for link detection. Range: 1-600.
Max Retries	Set the maximum retry times after it fails to dial up. Range: 0-9.
Use Peer DNS	Obtain peer DNS automatically during PPP dialing. DNS is necessary when visiting domain name.

Table 3-2-1-9 PPPoE Parameters

4. Dual-Stack Lite

Dual-Stack Lite (DS-Lite) uses IPv4-in-IPv6 tunneling to send a subscriber's IPv4 packet through a tunnel on the IPv6 access network to the ISP. The IPv6 packet is decapsulated to recover the subscriber's IPv4 packet and is then sent to the Internet after NAT address and port translation and other LSN related processing. The response packets traverse through the same path to the subscriber.

Enable	<input checked="" type="checkbox"/>
Port	LAN1/WAN
Connection Type	Dual-Stack Lite
IPv6 Gateway	
DS-Lite AFTR Address	
Local IPv6 Address	
MTU	1500
IPv4 Primary DNS	114.114.114.114
IPv4 Secondary DNS	8.8.8.8
IPv6 Primary DNS	
IPv6 Secondary DNS	
Enable NAT	<input checked="" type="checkbox"/>

Figure 3-2-1-11

Dual-Stack Lite	
Item	Description
IPv6 Gateway	Set the gateway for WAN port's IPv6 address.
DS-Lite AFTR Address	Set the DS-Lite AFTR server address.
Local IPv6 Address	Set the WAN port IPv6 address which use the same subnet as IPv6 gateway.

Table 3-2-1-10 Dual-Stack Lite Parameters

Related Configuration Example

[Ethernet WAN Connection](#)

3.2.1.5 Bridge

Bridge setting is used for managing local area network devices which are connected to LAN ports of the UR32, allowing each of them to access the Internet.

Bridge Setting

Name: Bridge0

STP:

IP Address: 192.168.1.1

Netmask: 255.255.255.0

IPv6 Address: 2004::1/64

MTU: 1500

Multiple IP Address

IP Address	Netmask	Operation
		<input style="background-color: #007bff; color: white; border: none; padding: 2px 5px;" type="button" value="+"/>

Figure 3-2-1-12

Bridge		
Item	Description	Default
Name	Show the name of bridge. "Bridge0" is set by default and cannot be changed.	Bridge0
STP	Enable/disable STP.	Disable
IP Address	Set the IP address for bridge.	192.168.1.1
Netmask	Set the Netmask for bridge.	255.255.255.0
IPv6 Address	Set the IPv6 address for bridge.	2004::1/64
MTU	Set the maximum transmission unit. Range: 68-1500.	1500
Multiple IP Address	Set the multiple IP addresses for bridge.	Null

Table 3-2-1-11 Bridge Settings

3.2.1.6 WLAN (Only Applicable to Wi-Fi Version)

This section explains how to set the related parameters for Wi-Fi network. UR32 supports 802.11 b/g/n, as AP or client mode.

WLAN

Enable

Work Mode

BSSID

Radio Type

Channel

Bandwidth

SSID

Encryption Mode

Cipher

Key

SSID Broadcast

AP Isolation

Guest Mode

Max Client Number

Figure 3-2-1-13

WLAN	
Item	Description
Enable	Enable/disable WLAN.
Work Mode	Select router's work mode. The options are "Client" or "AP".
Encryption Mode	Select encryption mode. The options are "No Encryption", "WEP Open System", "WEP Shared Key", "WPA-PSK", "WPA2-PSK" and "WPA-PSK/WPA2-PSK".
BSSID	Fill in the MAC address of the access point. Either SSID or BSSID can be filled to joint the network.
SSID	Fill in the SSID of the access point.
Client Mode	
Scan	Click "Scan" button to search the nearby access point.
SSID	Show SSID.
Channel	Show wireless channel.
Signal	Show wireless signal.
BSSID	Show the MAC address of the access point.
Cipher	Show the cipher of the access point.
Security	Show the encryption mode.
Frequency	Show the frequency of radio.

Join Network	Click the button to join the wireless network.
AP Mode	
Radio Type	Select Radio type. The options are "802.11b (2.4 GHz)", "802.11g (2.4 GHz)", "802.11n (2.4 GHz)".
Channel	Select wireless channel. The options are "Auto", "1", "2"..... "11".
Cipher	Select cipher. The options are "Auto", "AES", "TKIP" and "AES/TKIP".
Key	Fill the pre-shared key of WPA encryption.
Bandwidth	Select bandwidth. The options are "20MHz" and "40MHz".
SSID Broadcast	When SSID broadcast is disabled, other wireless devices can't not find the SSID, and users have to enter the SSID manually to access to the wireless network.
AP Isolation	When AP isolation is enabled, all users which access to the AP are isolated without communication with each other.
Guest Mode	The internal network is not allowed to visit if the guest mode is enabled.
Max Client Number	Set the maximum number of client to access when the router is configured as AP.
IP Setting	
Protocol	Set the IP address in wireless network.
IP Address	Set the IP address in wireless network.
Netmask	Set the netmask in wireless network.
Gateway	Set the gateway in wireless network.

Table 3-2-1-12 WLAN Parameters

MAC Filtering

Type: Allow and Block the Rest

MAC Address	Description	Operation
		+

Save & Apply

Figure 3-2-1-14

MAC Filtering	
Item	Description
Type	In this mode, you can choose the rule according to your security policy, which is 'Allow and Block the Rest' and 'Block and Allow the Rest', the default value is Disabled.
Allow and block the rest	Only the listed MAC addresses are allowed to connect to the router's wireless access point.
Block and allow the rest	The listed MAC addresses are not allowed to connect to the router's wireless access point.

Table 3-2-1-13 MAC Filtering Parameters

Related Topic

[Wi-Fi Application Example](#)

3.2.1.7 Switch

VLAN is a kind of new data exchange technology that realizes virtual work groups by logically dividing the LAN device into network segments.

The screenshot displays two configuration sections. The top section, 'LAN Settings', features a table with columns for Name, VLAN ID, IP Address, Netmask, MTU, and Operation. Below this is a 'VLAN Settings' section with a table for configuring VLAN 1. The columns are VLAN ID, LAN 1, LAN 2, LAN 3, LAN 4, CPU, and Operation. The 'VLAN ID' is set to 1, and the LAN ports are set to 'Untagged', while the CPU is set to 'Tagged'.

Figure 3-2-1-15

Switch	
Item	Description
LAN Settings	
Name	Set interface name of VLAN.
VLAN ID	Select VLAN ID of the interface.
IP Address	Set IP address of LAN port.
Netmask	Set Netmask of LAN port.
MTU	Set the maximum transmission unit of LAN port. Range: 68-1500.
VLAN Settings	
VLAN ID	Set the label ID of the VLAN. Range: 1-4094.
LAN 1/2/3/4	Make the VLAN bind with the corresponding ports and select status from "Tagged", "Untagged" and "Close" for Ethernet frame on trunk link.
CPU	Control communication between VLAN and other networks.

Table 3-2-1-14 VLAN Trunk Parameters

3.2.1.8 Loopback

Loopback interface is used for replacing router's ID as long as it is activated. When the interface is DOWN, the ID of the router has to be selected again which leads to long convergence time of OSPF. Therefore, Loopback interface is generally recommended as the ID of the router.

Loopback interface is a logic and virtual interface on router. Under default conditions, there's no loopback interface on router, but it can be created as required.

The screenshot shows a configuration page for Loopback Address. Under the heading "Loopback Address", there are two input fields: "IP Address" with the value "127.0.0.1" and "Netmask" with the value "255.0.0.0". Below this is a section titled "Multiple IP Addresses" which contains a table with three columns: "IP Address", "Netmask", and "Operation". The table is currently empty, and there is a blue plus sign icon in the bottom right corner of the table area. At the bottom of the configuration area is a blue "Save" button.

Figure 3-2-1-16

Loopback		
Item	Description	Default
IP Address	Unalterable	127.0.0.1
Netmask	Unalterable	255.0.0.0
Multiple IP Addresses	Apart from the IP above, user can configure other IP addresses.	Null

Table 3-2-1-15 Loopback Parameters

3.2.2 DHCP

DHCP adopts Client/Server communication mode. The Client sends configuration request to the Server which feeds back corresponding configuration information and distributes IP address to the Client so as to achieve the dynamic configuration of IP address and other information.

3.2.2.1 DHCP Server/DHCPv6 Server

UR32 can be set as a DHCP server or DHCPv6 server to distribute IP address when a host logs on and ensures each host is supplied with different IP addresses. DHCP Server has simplified some previous network management tasks requiring manual operations to the largest extent. UR32 only supports stateful DHCPv6 when working as DHCPv6 server.

DHCP Server DHCPv6 Server DHCP Relay

— DHCP Server_1

Enable

Interface

Start Address

End Address

Netmask

Lease Time(Min)

Primary DNS Server

Secondary DNS Server

Windows Name Server

Static IP

MAC Address	IP Address	Operation
		<input type="button" value="+"/>

Figure 3-2-2-1

DHCP Server DHCPv6 Server DHCP Relay

— DHCPv6 Server_1

Enable

Interface

Start Address

End Address

Prefix Length

Lease Time(Min)

Primary DNS Server

Secondary DNS Server

Static IP

DUID	IPv6 Address	Operation
		<input type="button" value="+"/>

Figure 3-2-2-2

DHCP/DHCPv6 Server		
Item	Description	Default
Enable	Enable or disable DHCP server.	Enable
Interface	Select interface.	Bridge0
Start Address	Define the beginning of the pool of IP addresses which will be leased to DHCP clients.	192.168.1.0 0
End Address	Define the end of the pool of IP addresses which will be leased to DHCP clients.	192.168.1.9 9
Netmask	Define the subnet mask of IPv4 address obtained by DHCP clients from DHCP server.	255.255.255 .0

Prefix Length	Set the IPv6 prefix length of IPv6 address obtained by DHCP clients from DHCP server.	64
Lease Time (Min)	Set the lease time on which the client can use the IP address obtained from DHCP server. Range: 1-10080.	1440
Primary DNS Server	Set the primary DNS server.	192.168.1.1
Secondary DNS Server	Set the secondary DNS server.	Null
Windows Name Server	Define the Windows Internet Naming Service obtained by DHCP clients from DHCP sever. Generally you can leave it blank.	Null
Static IP		
MAC Address	Set a static and specific MAC address for the DHCP client (it should be different from other MACs so as to avoid conflict).	Null
DUID	Set a static and specific DUID for the DHCPv6 client (it should be different from other DUID so as to avoid conflict).	Null
IP Address	Set a static and specific IP address for the DHCP client (it should be outside of the DHCP range).	Null

Table 3-2-2-1 DHCP Server Parameters

3.2.2.2 DHCP Relay

UR32 can be set as DHCP Relay to provide a relay tunnel to solve the problem that DHCP Client and DHCP Server are not in the same subnet.

Figure 3-2-2-3

DHCP Relay	
Item	Description
Enable	Enable or disable DHCP relay.
DHCP Server	Set DHCP server, up to 10 servers can be configured; separate them by blank space or ",".

Table 3-2-2-2 DHCP Relay Parameters

3.2.3 Firewall

This section describes how to set the firewall parameters, including security, ACL, DMZ, Port Mapping, MAC Binding and SPI.

The firewall implements corresponding control of data flow at entry direction (from Internet to local area network) and exit direction (from local area network to Internet) according to the content features of packets, such as protocol style, source/destination IP address, etc. It ensures that the router operate in a safe environment and host in local area network.

3.2.3.1 Security

Prevent Attack

DoS/DDoS Protection

Access Service Control

Service	Port	Local	Remote
HTTP	80	<input checked="" type="checkbox"/>	<input checked="" type="checkbox"/>
HTTPS	443	<input checked="" type="checkbox"/>	<input checked="" type="checkbox"/>
TELNET	23	<input checked="" type="checkbox"/>	<input checked="" type="checkbox"/>
SSH	22	<input checked="" type="checkbox"/>	<input checked="" type="checkbox"/>
FTP	21	<input type="checkbox"/>	<input checked="" type="checkbox"/>

Website Blocking

URL Blocking

Keyword Blocking

Figure 3-2-3-1

Item	Description	Default
Prevent Attack		
DoS/DDoS Protection	Enable/disable Prevent DoS/DDoS Attack.	Disable
Access Service Control		
Port	Set port number of the services. Range: 1-65535.	--
Local	Access the router locally.	Enable
Remote	Access the router remotely.	Disable
HTTP	Users can log in the device locally via HTTP to access and control it through Web after the option is checked.	80

HTTPS	Users can log in the device locally and remotely via HTTPS to access and control it through Web after option is checked.	443
TELNET	Users can log in the device locally and remotely via Telnet after the option is checked.	23
SSH	Users can log in the device locally and remotely via SSH after the option is checked.	22
FTP	Users can log in the device locally and remotely via FTP after the option is checked.	21
Website Blocking		
URL Blocking	Enter the HTTP address which you want to block.	
Keyword Blocking	You can block specific website by entering keyword. The maximum number of character allowed is 64.	

Table 3-2-3-1 Security Parameters

3.2.3.2 ACL

Access control list, also called ACL, implements permission or prohibition of access for specified network traffic (such as the source IP address) by configuring a series of matching rules so as to filter the network interface traffic. When router receives packet, the field will be analyzed according to the ACL rule applied to the current interface. After the special packet is identified, the permission or prohibition of corresponding packet will be implemented according to preset strategy.

The data package matching rules defined by ACL can also be used by other functions requiring flow distinction.

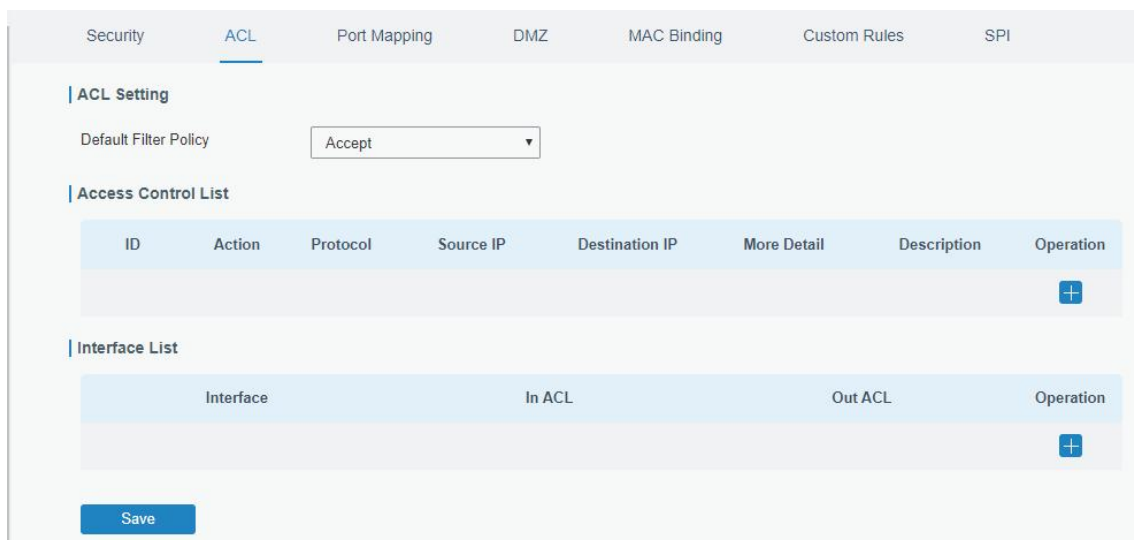

Figure 3-2-3-2

Type	extended
ID	
Action	permit
Protocol	tcp
Source IP	
Source Wildcard Mask	0.0.0.0
Source Port Type	any
Destination IP	
Destination Wildcard Mask	0.0.0.0
Destination Port Type	any
Description	

Figure 3-2-3-3

Item	Description
ACL Setting	
Default Filter Policy	Select from "Accept" and "Deny". The packets which are not included in the access control list will be processed by the default filter policy.
Access Control List	
Type	Select type from "Extended" and "Standard".
ID	User-defined ACL number. Range: 1-199.
Action	Select from "Permit" and "Deny".
Protocol	Select protocol from "ip", "icmp", "tcp", "udp", and "1-255".
Source IP	Source network address (leaving it blank means all).
Source Wildcard Mask	Wildcard mask of the source network address.
Destination IP	Destination network address (0.0.0.0 means all).
Destination Wildcard Mask	Wildcard mask of destination address.
Description	Fill in a description for the groups with the same ID.
ICMP Type	Enter the type of ICMP packet. Range: 0-255.
ICMP Code	Enter the code of ICMP packet. Range: 0-255.
Source Port Type	Select source port type, such as specified port, port range, etc.
Source Port	Set source port number. Range: 1-65535.
Start Source Port	Set start source port number. Range: 1-65535.
End Source Port	Set end source port number. Range: 1-65535.
Destination Port Type	Select destination port type, such as specified port, port range, etc.

Destination Port	Set destination port number. Range: 1-65535.
Start Destination Port	Set start destination port number. Range: 1-65535.
End Destination Port	Set end destination port number. Range: 1-65535.
More Details	Show information of the port.
Interface List	
Interface	Select network interface for access control.
In ACL	Select a rule for incoming traffic from ACL ID.
Out ACL	Select a rule for outgoing traffic from ACL ID.

Table 3-2-3-2 ACL Parameters

3.2.3.3 Port Mapping (DNAT)

When external services are needed internally (for example, when a website is published externally), the external address initiates an active connection. And, the router or the gateway on the firewall receives the connection. Then it will convert the connection into the an internal connection. This conversion is called DNAT, which is mainly used for external and internal services.

Source IP	Source Port	Destination IP	Destination Port	Protocol	Description	Operation
0.0.0.0/0				TCP		X
						+

Figure 3-2-3-3

Port Mapping	
Item	Description
Source IP	Specify the host or network which can access local IP address. 0.0.0.0/0 means all.
Source Port	Enter the TCP or UDP port from which incoming packets are forwarded. Range: 1-65535.
Destination IP	Enter the IP address that packets are forwarded to after being received on the incoming interface.
Destination Port	Enter the TCP or UDP port that packets are forwarded to after being received on the incoming port(s). Range: 1-65535.
Protocol	Select from "TCP" and "UDP" as your application required.
Description	The description of this rule.

Table 3-2-3-3 Port Mapping Parameters

Related Configuration Example

[NAT Application Example](#)

3.2.3.4 DMZ

DMZ is a host within the internal network that has all ports exposed, except those forwarded ports in port mapping.

Figure 3-2-3-4

DMZ	
Item	Description
Enable	Enable or disable DMZ.
DMZ Host	Enter the IP address of the DMZ host on the internal network.
Source Address	Set the source IP address which can access to DMZ host. "0.0.0.0/0" means any address.

Table 3-2-3-4 DMZ Parameters

3.2.3.5 MAC Binding

MAC Binding is used for specifying hosts by matching MAC addresses and IP addresses that are in the list of allowed outer network access.

Figure 3-2-3-5

MAC Binding List	
Item	Description
MAC Address	Set the binding MAC address.
IP Address	Set the binding IP address.
Description	Fill in a description for convenience of recording the meaning of the binding rule for each piece of MAC-IP.

Table 3-2-3-5 MAC Binding Parameters

3.2.3.6 Custom Rules

In this page, you can configure your own custom firewall iptables rules.

The screenshot shows a web interface for configuring custom rules. At the top, there's a header 'Custom Rules'. Below it is a table with three columns: 'Rule', 'Description', and 'Operation'. The 'Rule' column contains the text 'Eg: -t filter -I INPUT -s 192.168.3.240 -j DROP'. The 'Description' column is empty. The 'Operation' column has a blue 'x' icon. Below the table, there are blue buttons for '+', 'Save', and '-'. The 'Save' button is at the bottom left.

Figure 3-2-3-6

Custom Rules	
Item	Description
Rule	Specify an iptables rule like the example shows. Tips: You must reboot the device to take effect after modifying or deleting the iptables rules.
Description	Enter the description of the rule.

Table 3-2-3-6 Custom Rules Parameters

3.2.3.7 SPI

The screenshot shows a web interface for configuring SPI Firewall. It has a header 'SPI Firewall'. Below it is a list of checkboxes with labels: 'Enable', 'Filter Proxy', 'Filter Cookies', 'Filter ActiveX', 'Filter Java Applets', 'Filter Multicast', 'Filter IDENT(port 113)', 'Block Wan SNMP access', 'Filter WAN NAT Redirection', and 'Block Anonymous Wan Request'. The 'Enable' checkbox is checked. At the bottom, there is a blue 'Save' button.

Figure 3-2-3-7

SPI Firewall	
Item	Description
Enable	Enable/disable SPI firewall.
Filter Proxy	Blocks HTTP requests containing the "Host": string.
Filter Cookies	Identifies HTTP requests that contain "Cookie": String and mangle the cookie. Attempts to stop cookies from being used.
Filter ActiveX	Blocks HTTP requests of the URL that ends in ".ocx" or ".cab".
Filter Java Applets	Blocks HTTP requests of the URL that ends in ".js" or ".class".
Filter Multicast	Prevent multicast packets from reaching the LAN.

Filter IDENT(port 113)	Prevent WAN access to Port 113.
Block WAN SNMP access	Block SNMP requests from the WAN.
Filter WAN NAT Redirection	Prevent hosts on LAN from using WAN address of router to connect servers on the LAN (which have been configured using port redirection).
Block Anonymous WAN Requests	Stop the router from responding to "pings" from the WAN.

Table 3-2-3-7 SPI Parameters

3.2.4 QoS

Quality of service (QoS) refers to traffic prioritization and resource reservation control mechanisms rather than the achieved service quality. QoS is engineered to provide different priority for different applications, users, data flows, or to guarantee a certain level of performance to a data flow.

The screenshot shows the QoS configuration interface with two tabs: QoS(Download) and QoS(Upload). The QoS(Download) tab is active. It includes sections for Download Bandwidth and Service Category. The Download Bandwidth section has an 'Enable' checkbox (unchecked), a 'Default Category' dropdown menu, a 'Download Bandwidth' input field (set to 0) with 'kbits/s' unit, and a 'Capacity' label. The Service Category section contains a table with columns: Name, Percent(%), Max BW(kbps), Min BW(kbps), and Operation. Below this is a 'Service Category Rules' section with a table with columns: Name, Source IP, Source Port, Destination IP, Destination Port, Protocol, Service Category, and Operation. A 'Save' button is located at the bottom left.

Figure 3-2-4-1

QoS	
Item	Description
Download/Upload	
Enable	Enable or disable QoS.
Default Category	Select the default category from Service Category list.
Download/Upload Bandwidth Capacity	The download/upload bandwidth capacity of the network that the router is connected with, in kbps. Range: 1-8000000.
Service Category	
Name	You can use characters such digits, letters and "-".
Percent (%)	Set percent for the service category. Range: 0-100.
Max BW(kbps)	The maximum bandwidth that this category is allowed to consume, in kbps. The value should be less than the "Download/Upload Bandwidth Capacity" when the traffic is

	blocked.
Min BW(kbps)	The minimum bandwidth that can be guaranteed for the category, in kbps.The value should be less than the "MAX BW" value.
Service Category Rules	
Item	Description
Name	Give the rule a descriptive name.
Source IP	Source address of flow control (leaving it blank means any).
Source Port	Source port of flow control. Range: 0-65535 (leaving it blank means any).
Destination IP	Destination address of flow control (leaving it blank means any).
Destination Port	Destination port of flow control. Range: 0-65535 (leaving it blank means any).
Protocol	Select protocol from "ANY", "TCP", "UDP", "ICMP", and "GRE".
Service Category	Set service category for the rule.

Table 3-2-4-1 QoS (Download/Upload) Parameters

Related Configuration Example

[QoS Application Example](#)

3.2.5 VPN

Virtual Private Networks, also called VPNs, are used to securely connect two private networks together so that devices can connect from one network to the other network via secure channels.

The UR32 supports DMVPN, IPsec, GRE, L2TP, PPTP, OpenVPN, as well as GRE over IPsec and L2TP over IPsec.

3.2.5.1 DMVPN

A dynamic multi-point virtual private network (DMVPN), combining mGRE and IPsec, is a secure network that exchanges data between sites without passing traffic through an organization's headquarter VPN server or router.

DMVPN Settings

Enable

Hub Address

Local IP Address

GRE HUB IP Address

GRE Local IP Address

GRE Mask

GRE Key

Negotiation Mode

Authentication Algorithm

Encryption Algorithm

DH Group

Key

Local ID Type

IKE Life Time(s)

SA Algorithm

PFS Group

Life Time(s)

DPD Time Interval(s)

DPD Timeout(s)

Cisco Secret

NHRP Holdtime(s)

Figure 3-2-5-1

DMVPN	
Item	Description
Enable	Enable or disable DMVPN.
Hub Address	The IP address or domain name of DMVPN Hub.
Local IP address	DMVPN local tunnel IP address.
GRE Hub IP Address	GRE Hub tunnel IP address.
GRE Local IP Address	GRE local tunnel IP address.
GRE Netmask	GRE local tunnel netmask.
GRE Key	GRE tunnel key.
Negotiation Mode	Select from "Main" and "Aggressive".
Authentication Algorithm	Select from "DES", "3DES", "AES128", "AES192" and "AES256".
Encryption Algorithm	Select from "MD5" and "SHA1".
DH Group	Select from "MODP768_1", "MODP1024_2" and "MODP1536_5".
Key	Enter the preshared key.
Local ID Type	Select from "Default", "ID", "FQDN", and "User FQDN"
IKE Life Time (s)	Set the lifetime in IKE negotiation. Range: 60-86400.
SA Algorithm	Select from "DES_MD5", "DES_SHA1", "3DES_MD5", "3DES_SHA1", "AES128_MD5", "AES128_SHA1", "AES192_MD5", "AES192_SHA1", "AES256_MD5" and "AES256_SHA1".
PFS Group	Select from "NULL", "MODP768_1", "MODP1024_2" and "MODP1536-5".

Life Time (s)	Set the lifetime of IPsec SA. Range: 60-86400.
DPD Interval Time (s)	Set DPD interval time
DPD Timeout (s)	Set DPD timeout.
Cisco Secret	Cisco Nhrp key.
NHRP Holdtime (s)	The holdtime of NHRP protocol.

Table 3-2-5-1 DMVPN Parameters

3.2.5.2 IPsec Server

IPsec is especially useful for implementing virtual private networks and for remote user access through dial-up connection to private networks. A big advantage of IPsec is that security arrangements can be handled without requiring changes to individual user computers.

IPsec provides three choices of security service: Authentication Header (AH), Encapsulating Security Payload (ESP), and Internet Key Exchange (IKE). AH essentially allows authentication of the senders' data. ESP supports both authentication of the sender and data encryption. IKE is used for cipher code exchange. All of them can protect one and more data flows between hosts, between host and gateway, and between gateways.

Figure 3-2-5-2

IPsec Server	
Item	Description
Enable	Enable or disable IPsec server mode.
IPsec Mode	Select Tunnel or Transport.
IPsec Protocol	Select from ESP or AH.
Local Subnet	Enter the local LAN subnet IP address on the IPsec tunnel.
Local Subnet Netmask	Enter the local LAN netmask on the IPsec tunnel.
Local ID Type	Select the identifier type, and send it to remote peer. Default: None

	ID: use local subnet IP address as ID FQDN: fully qualified domain name, example: test.user.com User FQDN: fully qualified username string with email address format, example: test@user.com
Remote Subnet	Set the remote LAN subnet on the IPsec tunnel.
Remote Subnet Mask	Enter the remote LAN netmask on the IPsec tunnel.
Remote ID type	Select the identifier type that is the same as remote peer local ID. Default: None ID: use remote subnet IP address as ID FQDN: fully qualified domain name, example: test.user.com User FQDN: fully qualified username string with email address format, example: test@user.com

Table 3-2-5-2 IPsec Server Parameters

IKE Parameter

IKE Version: IKEv1

Negotiation Mode: Main

Encryption Algorithm: DES

Authentication Algorithm: MD5

DH Group: MODP768-1

Local Authentication: PSK

XAUTH

Lifetime(s): 10800

XAUTH List

Username	Password	Operation
		+

PSK List

Selector	PSK	Operation
		+

Figure 3-2-5-3

SA Parameter	<input checked="" type="checkbox"/>
SA Encryption Algorithm	DES
SA Authentication Algorithm	MD5
PFS Group	NULL
Lifetime(s)	3600
DPD Time Interval(s)	30
DPD Timeout(s)	150
IPsec Advanced	<input type="checkbox"/>
Expert Options	

Figure 3-2-5-4

IKE Parameter	
Item	Description
IKE Version	Select the method of key exchange from IKEv1 and IKEv2.
Negotiation Mode	When using IKEv1, select Main or Aggressive.
Encryption Algorithm	Select DES, 3DES, AES128, AES192 or AES256.
Authentication Algorithm	Select MD5, SHA1 or SHA2-256.
DH Group	Select MODP768-1, MODP1024-2, MODP1536-5, MODP2048-14 or MODP3072-15..
Local Authentication	Select PSK or CA. PSK: use pre-shared key to complete the authentication. CA: use certificate to complete the authentication. After selecting, go to Network > VPN > > Certifications page to import CA certificate, local certificate and private key to corresponding fields.
Remote Authentication	When using IKEv2, select PSK or CA. PSK: use pre-shared key to complete the authentication. CA: use certificate to complete the authentication. After selecting, go to Network > VPN > > Certifications page to import remote certificate to corresponding fields.
XAUTH	When using IKEv1, define XAUTH username and password after XAUTH is enabled.
Lifetime (s)	Set the lifetime in IKE negotiation. Range: 60-86400.
XAUTH List	
Username	Enter the username used for the xauth authentication.
Password	Enter the password used for the xauth authentication.
PSK List	
Selector	Enter the corresponding identification number for PSK authentication.
PSK	Enter the pre-shared key.
SA Parameter	
SA Encryption Algorithm	Select DES, 3DES, AES128, AES192 or AES256.

SA Authentication Algorithm	Select MD5, SHA1 or SHA2-256.
PFS Group	Select NULL, MODP768-1 , MODP1024-2 or MODP1536-5.
Lifetime (s)	Set the lifetime of IPsec SA. Range: 60-86400 s.
DPD Time Interval(s)	Set DPD retry interval to send DPD requests. Range: 1-86400 s
DPD Timeout(s)	Set DPD timeout to detect the remote side fails. Range: 10-86400 s.
IPsec Advanced	
Enable Compression	The head of IP packet will be compressed after it's enabled.
Margintime	Set advanced time before the lifetime expires to begin the re-negotiation.
VPN Over IPsec Type	Select from NONE, GRE and L2TP.
Expert Options	User can enter some other initialization strings in this field and separate the strings with semicolon.

Table 3-2-5-3 IPsec Server Parameters

3.2.5.3 IPsec

UR32 supports running at most 3 IPsec clients at the same time.

The screenshot displays the 'IPsec Settings' configuration page. At the top, there is a header 'IPsec Settings' and a sub-header 'IPsec_1'. Below this, a list of configuration items is shown, each with a corresponding input field or checkbox:

- Enable:
- IPsec Gateway Address:
- IPsec Mode:
- IPsec Protocol:
- Local Subnet:
- Local Subnet Mask:
- Local ID Type:
- Remote Subnet:
- Remote Subnet Mask:
- Remote ID Type:
- IKE Parameter:
- SA Parameter:
- IPsec Advanced:
- Expert Options:

At the bottom of the settings area, there are three expandable sections labeled '+ IPsec_2' and '+ IPsec_3'.

Figure 3-2-5-5

IPsec	
Item	Description

Enable	Enable or disable IPsec client mode. A maximum of 3 tunnels is allowed.
IP Gateway Address	Enter the remote IPsec server address.
IPsec Mode	Select Tunnel or Transport.
IPsec Protocol	Select from ESP or AH.
Local Subnet	Enter the local LAN subnet IP address on the IPsec tunnel.
Local Subnet Netmask	Enter the local LAN netmask on the IPsec tunnel.
Local ID Type	Select the identifier type, and send it to remote peer. Default: None ID: use local subnet IP address as ID FQDN: fully qualified domain name, example: test.user.com User FQDN: fully qualified username string with email address format, example: test@user.com
Remote Subnet	Set the remote LAN subnet on the IPsec tunnel.
Remote Subnet Mask	Enter the remote LAN netmask on the IPsec tunnel.
Remote ID type	Select the identifier type that is the same as remote peer local ID. Default: None ID: use remote subnet IP address as ID FQDN: fully qualified domain name, example: test.user.com User FQDN: fully qualified username string with email address format, example: test@user.com

Table 3-2-5-4 IPsec Parameters

IKE Parameter	<input checked="" type="checkbox"/>
IKE Version	IKEv1
Negotiation Mode	Main
Encryption Algorithm	DES
Authentication Algorithm	MD5
DH Group	MODP768-1
Local Authentication	PSK
Local Secrets	
XAUTH	<input type="checkbox"/>
Lifetime(s)	10800
SA Parameter	<input checked="" type="checkbox"/>
SA Encryption Algorithm	DES
SA Authentication Algorithm	MD5
PFS Group	NULL
Lifetime(s)	3600
DPD Time Interval(s)	30
DPD Timeout(s)	150
IPsec Advanced	<input type="checkbox"/>
Expert Options	

Figure 3-2-5-6

IKE Parameter	
Item	Description
IKE Version	Select the method of key exchange from IKEv1 and IKEv2.
Negotiation Mode	When using IKEv1, select Main or Aggressive.
Encryption Algorithm	Select DES, 3DES, AES128, AES192 or AES256.
Authentication Algorithm	Select MD5, SHA1 or SHA2-256.
DH Group	Select MODP768-1, MODP1024-2, MODP1536-5, MODP2048-14 or MODP3072-15..
Local Authentication	Select PSK or CA. PSK: use pre-shared key to complete the authentication. CA: use certificate to complete the authentication. After selecting, go to Network > VPN > > Certifications page to import CA certificate, local certificate and private key to corresponding fields.
Local Secrets	Enter the pre-shared key which is defined on serer side.
Remote Authentication	When using IKEv2, select PSK or CA.

	<p>PSK: use pre-shared key to complete the authentication.</p> <p>CA: use certificate to complete the authentication. After selecting, go to Network > VPN > > Certifications page to import remote certificate to corresponding fields.</p>
Remote Secrets	Enter the pre-shared key which is defined on server side.
XAUTH	Enter XAUTH username and password which is defined on server side.
Lifetime (s)	Set the lifetime in IKE negotiation. Range: 60-86400.
SA Parameter	
SA Encryption Algorithm	Select DES, 3DES, AES128, AES192 or AES256.
SA Authentication Algorithm	Select MD5, SHA1 or SHA2-256.
PFS Group	Select NULL, MODP768-1 , MODP1024-2 or MODP1536-5.
Lifetime (s)	Set the lifetime of IPsec SA. Range: 60-86400 s.
DPD Time Interval(s)	Set DPD retry interval to send DPD requests. Range: 1-86400 s
DPD Timeout(s)	Set DPD timeout to detect the remote side fails. Range: 10-86400 s.
IPsec Advanced	
Enable Compression	The head of IP packet will be compressed after it's enabled.
Margintime	Set advanced time before the lifetime expires to begin the re-negotiation.
VPN Over IPsec Type	Select from NONE, GRE and L2TP.
Expert Options	User can enter some other initialization strings in this field and separate the strings with semicolon.

Table 3-2-5-5 IPsec Parameters

3.2.5.4 GRE

Generic Routing Encapsulation (GRE) is a protocol that encapsulates packets in order to route other protocols over IP networks. It's a tunneling technology that provides a channel through which encapsulated data message could be transmitted and encapsulation and decapsulation could be realized at both ends.

In the following circumstances the GRE tunnel transmission can be applied:

- GRE tunnel could transmit multicast data packets as if it were a true network interface. Single use of IPSec cannot achieve the encryption of multicast.
- A certain protocol adopted cannot be routed.
- A network of different IP addresses shall be required to connect other two similar networks.

The screenshot shows the 'GRE Settings' configuration page for a device. It features a list of settings for a GRE tunnel named 'GRE_1'. The settings include:

- Enable:** A checkbox that is currently unchecked.
- Remote IP Address:** An empty text input field.
- Local IP Address:** An empty text input field.
- Local Virtual IP Address:** An empty text input field.
- Netmask:** A text input field containing the value '255.255.255.0'.
- Peer Virtual IP Address:** An empty text input field.
- Global Traffic Forwarding:** A checkbox that is currently unchecked.
- Remote Subnet:** An empty text input field.
- Remote Netmask:** An empty text input field.
- MTU:** A text input field containing the value '1500'.
- Key:** An empty text input field.
- Enable NAT:** A checkbox that is currently checked.

Below the 'GRE_1' settings, there are expandable sections for 'GRE_2' and 'GRE_3', each indicated by a plus sign (+).

Figure 3-2-5-7

GRE	
Item	Description
Enable	Check to enable GRE function.
Remote IP Address	Enter the real remote IP address of GRE tunnel.
Local IP Address	Set the local IP address.
Local Virtual IP Address	Set the local tunnel IP address of GRE tunnel.
Netmask	Set the local netmask.
Peer Virtual IP Address	Enter remote tunnel IP address of GRE tunnel.
Global Traffic Forwarding	All the data traffic will be sent out via GRE tunnel when this function is enabled.
Remote Subnet	Enter the remote subnet IP address of GRE tunnel.
Remote Netmask	Enter the remote netmask of GRE tunnel.
MTU	Enter the maximum transmission unit. Range: 64-1500.
Key	Set GRE tunnel key.
Enable NAT	Enable NAT traversal function.

Table 3-2-5-6 GRE Parameters

3.2.5.5 L2TP

Layer Two Tunneling Protocol (L2TP) is an extension of the Point-to-Point Tunneling Protocol (PPTP) used by an Internet service provider (ISP) to enable the operation of a virtual private network (VPN) over the Internet.

L2TP Settings

— L2TP_1

Enable

Remote IP Address

Hostname

Username

Password

Authentication

Global Traffic Forwarding

Remote Subnet

Remote Subnet Mask

Key

Advanced Settings

+ L2TP_2

+ L2TP_3

Figure 3-2-5-8

L2TP	
Item	Description
Enable	Check to enable L2TP function.
Remote IP Address	Enter the public IP address or domain name of L2TP server.
Hostname	Enter the hostname to verify with L2TP server.
Username	Enter the username that L2TP server provides.
Password	Enter the password that L2TP server provides.
Authentication	Select from "Auto", "PAP", "CHAP", "MS-CHAPv1" and "MS-CHAPv2".
Global Traffic Forwarding	All of the data traffic will be sent out via L2TP tunnel after this function is enabled.
Remote Subnet	Enter the remote IP address that L2TP protects.
Remote Subnet Mask	Enter the remote netmask that L2TP protects.
Key	Enter the password of L2TP tunnel.

Table 3-2-5-7 L2TP Parameters

Advanced Settings	<input checked="" type="checkbox"/>
Local IP Address	<input type="text"/>
Peer IP Address	<input type="text"/>
Enable NAT	<input checked="" type="checkbox"/>
Enable MPPE	<input checked="" type="checkbox"/>
Address/Control Compression	<input type="checkbox"/>
Protocol Field Compression	<input type="checkbox"/>
Asyncmap Value	<input type="text" value="ffffff"/>
MRU	<input type="text" value="1500"/>
MTU	<input type="text" value="1500"/>
Link Detection Interval(s)	<input type="text" value="60"/>
Max Retries	<input type="text" value="0"/>
Expert Options	<input type="text"/>

Figure 3-2-5-9

Advanced Settings	
Item	Description
Local IP Address	Set tunnel IP address of L2TP client. Client will obtain tunnel IP address automatically from the server when it's null.
Peer IP Address	Enter tunnel IP address of L2TP server.
Enable NAT	Enable NAT traversal function.
Enable MPPE	Enable MPPE encryption.
Address/Control Compression	For PPP initialization. User can keep the default option.
Protocol Field Compression	For PPP initialization. User can keep the default option.
Asyncmap Value	One of the PPP protocol initialization strings. User can keep the default value. Range: 0-ffffff.
MRU	Set the maximum receive unit. Range: 64-1500.
MTU	Set the maximum transmission unit. Range: 64-1500
Link Detection Interval (s)	Set the link detection interval time to ensure tunnel connection. Range: 0-600.
Max Retries	Set the maximum times of retry to detect the L2TP connection failure. Range: 0-10.
Expert Options	User can enter some other PPP initialization strings in this field and separate the strings with blank space.

Table 3-2-5-8 L2TP Parameters

3.2.5.6 PPTP

Point-to-Point Tunneling Protocol (PPTP) is a protocol that allows corporations to extend their own corporate network through private "tunnels" over the public Internet. Effectively, a corporation uses a wide-area network as a single large local area network.

The screenshot displays the 'PPTP Settings' interface. At the top, there is a header 'PPTP Settings' and a sub-header 'PPTP_1'. Below this, several configuration options are listed with corresponding input fields or checkboxes:

- Enable:** A checkbox that is currently unchecked.
- Remote IP Address:** A text input field.
- Username:** A text input field.
- Password:** A text input field.
- Authentication:** A dropdown menu with 'Auto' selected.
- Global Traffic Forwarding:** A checkbox that is currently unchecked.
- Remote Subnet:** A text input field.
- Remote Subnet Mask:** A text input field.
- Advanced Settings:** A button with a right-pointing arrow.

Below the PPTP_1 section, there are two expandable sections for 'PPTP_2' and 'PPTP_3', each with a plus sign icon. At the bottom of the settings area, there is a blue 'Save' button.

Figure 3-2-5-10

PPTP	
Item	Description
Enable	Enable PPTP client. A maximum of 3 tunnels is allowed.
Remote IP Address	Enter the public IP address or domain name of PPTP server.
Username	Enter the username that PPTP server provides.
Password	Enter the password that PPTP server provides.
Authentication	Select from "Auto", "PAP", "CHAP", "MS-CHAPv1", and "MS-CHAPv2".
Global Traffic Forwarding	All of the data traffic will be sent out via PPTP tunnel once enable this function.
Remote Subnet	Set the peer subnet of PPTP.
Remote Subnet Mask	Set the netmask of peer PPTP server.

Table 3-2-5-9 PPTP Parameters

Advanced Settings	<input checked="" type="checkbox"/>
Local IP Address	<input type="text"/>
Peer IP Address	<input type="text"/>
Enable NAT	<input checked="" type="checkbox"/>
Enable MPPE	<input checked="" type="checkbox"/>
Address/Control Compression	<input type="checkbox"/>
Protocol Field Compression	<input type="checkbox"/>
Asyncmap Value	<input type="text" value="ffffff"/>
MRU	<input type="text" value="1500"/>
MTU	<input type="text" value="1500"/>
Link Detection Interval(s)	<input type="text" value="60"/>
Max Retries	<input type="text" value="0"/>
Expert Options	<input type="text"/>

Figure 3-2-5-11

PPTP Advanced Settings	
Item	Description
Local IP Address	Set IP address of PPTP client.
Peer IP Address	Enter tunnel IP address of PPTP server.
Enable NAT	Enable the NAT faction of PPTP.
Enable MPPE	Enable MPPE encryption.
Address/Control Compression	For PPP initialization. User can keep the default option.
Protocol Field Compression	For PPP initialization. User can keep the default option.
Asyncmap Value	One of the PPP protocol initialization strings. User can keep the default value. Range: 0-ffffff.
MRU	Enter the maximum receive unit. Range: 0-1500.
MTU	Enter the maximum transmission unit. Range: 0-1500.
Link Detection Interval (s)	Set the link detection interval time to ensure tunnel connection. Range: 0-600.
Max Retries	Set the maximum times of retrying to detect the PPTP connection failure. Range: 0-10.
Expert Options	User can enter some other PPP initialization strings in this field and separate the strings with blank space.

Table 3-2-5-10 PPTP Parameters

3.2.5.7 OpenVPN Client

OpenVPN is an open source virtual private network (VPN) product that offers a simplified security

framework, modular network design, and cross-platform portability. The default OpenVPN version of UR32 is 2.4.9.

UR32 supports running at most 3 OpenVPN clients at the same time. You can import the ovpn file directly or configure the parameters on this page to set clients.

Figure 3-2-5-12

OpenVPN Client - File Configuration

Item	Description
Browse	Click to browse the client configuration ovpn format file including the settings and certificate contents. Please refer to the client configuration file according to sample: client.conf
Edit	Click to edit the imported file.
Export	Export the server configuration file.
Delete	Click to delete the configuration file.

Table 3-2-5-11 OpenVPN Client Parameters

Figure 3-2-5-13

OpenVPN Client - Page Configuration	
Item	Description
Protocol	Select a transport protocol used by connecting UDP and TCP.
Remote IP Address	Enter remote OpenVPN server's IP address or domain name.
Port	Enter the TCP/UCP service number of remote OpenVPN server. Range: 1-65535.
Interface	Select virtual VPN network interface type from TUN and TAP. TUN devices encapsulate IPv4 or IPv6 (OSI Layer 3) while TAP devices encapsulate Ethernet 802.3 (OSI Layer 2).
Authentication Type	Select authentication type used to secure data sessions. Pre-shared: use the same secret key as server to complete the authentication. After selecting, go to Network > VPN > Certifications page to import a static.key to PSK field. Username/Password: use username/password which is preset in server side to complete the authentication. X.509 cert: use X.509 type certificate to complete the authentication. After selecting, go to Network > VPN > Certifications page to import CA certificate, client certificate and client private key to corresponding fields. X.509 cert + user: use both username/password and X.509 cert authentication type.
Local Virtual IP	Set local tunnel address when authentication type is None or Pre-shared .
Remote Virtual IP	Set remote tunnel address when authentication type is None or Pre-shared .
Global Traffic Forwarding	All the data traffic will be sent out via OpenVPN tunnel when this function is enabled.
Enable TLS Authentication	Select from None, TLS Auth and TLS Crypt. When selecting TLS Auth or TLS Crypt, go to Network > VPN > Certifications page to import a ta.key.
Compression	Select to enable or disable LZO to compress data.
Link Detection Interval (s)	Set link detection interval time to ensure tunnel connection. If this is set on both server and client, the value pushed from server will override the client local values. Range: 10-1800 s.
Link Detection Timeout (s)	OpenVPN will be reestablished after timeout. If this is set on both server and client, the value pushed from server will override the client local values. Range: 60-3600 s.
Cipher	Select from NONE, BF-CBC, DES-CBC, DES-EDE3-CBC, AES-128-CBC, AES-192-CBC and AES-256-CBC.
Authentication Mode	Select from NONE, MD5, SHA1, SHA256, and SHA512.
MTU	Enter the maximum transmission unit. Range: 128-1500.
Max Frame Size	Set the maximum frame size. Range: 128-1500.
Verbose Level	Select from ERROR, WARING, NOTICE and DEBUG.
Expert Options	User can enter some initialization strings in this field and separate the strings with semicolon. Example: ncp-ciphers AES-128-GCM; key direction 1

Local Route

Subnet	Set the local route's IP address.
Subnet Mask	Set the local route's netmask.

Table 3-2-5-12 OpenVPN Client Parameters

Related Topic

[OpenVPN Client Application Example](#)

3.2.5.8 OpenVPN Server

The UR32 supports OpenVPN server to create secure point-to-point or site-to-site connections in routed or bridged configurations and remote access facilities. You can import the ovpn file directly or configure the parameters on this page to set this server. UR32 supports at most 20 openVPN clients connections.

OpenVPN Server Settings

Enable

Configuration Method

Configuration File

Figure 3-2-5-14

OpenVPN Server - File Configuration	
Item	Description
Browse	Click to browse the server configuration ovpn format file including the settings and certificate contents. Please refer to the server configuration file according to sample: server.conf
Edit	Click to edit the imported file.
Export	Export the server configuration file.
Delete	Click to delete the configuration file.

Table 3-2-5-13 OpenVPN Server Parameters

Enable	<input checked="" type="checkbox"/>
Configuration Method	Page Configuration ▾
Protocol	UDP ▾
Port	1194
Listening IP	
Interface	tun ▾
Authentication	None ▾
Local Virtual IP	
Remote Virtual IP	
Enable NAT	<input checked="" type="checkbox"/>
Compression	LZO ▾
Link Detection Interval	60
Link Detection Timeout	150
Cipher	None ▾
Authentication Mode	None ▾
MTU	1500
Max Frame Size	1500
Verbose Level	ERROR ▾
Expert Options	

Figure 3-2-5-15

Account			
Username	Password	Operation	
		+	
Local Route			
Subnet	Netmask	Operation	
		+	
Client Subnet			
Name	Subnet	Netmask	Operation
			+

Figure 3-2-5-16

OpenVPN Server - Page Configuration	
Item	Description
Protocol	Select a transport protocol used by connection from UDP and TCP.
Listening IP	Enter the local hostname or IP address for bind. If left blank, OpenVPN server will bind to all interfaces.
Port	Enter the TCP/UCP service number for OpenVPN client connection. Range: 1-65535.

Interface	Select virtual VPN network interface type from TUN and TAP. TUN devices encapsulate IPv4 or IPv6 (OSI Layer 3) while TAP devices encapsulate Ethernet 802.3 (OSI Layer 2).
Authentication Type	Select authentication type used to secure data sessions. Pre-shared: use the same secret key as server to complete the authentication. After select, go to Network > VPN > Certifications page to import a static.key to PSK field. Username/Password: use username/password which is preset in server side to complete the authentication. X.509 cert: use X.509 type certificate to complete the authentication. After select, go to Network > VPN > Certifications page to import CA certificate, client certificate and client private key to corresponding fields. X.509 cert + user: use both username/password and X.509 cert authentication type.
Local Virtual IP	Set local tunnel address when authentication type is None or Pre-shared .
Remote Virtual IP	Set remote tunnel address when authentication type is None or Pre-shared .
Client Subnet	Define an IP address pool for openVPN client.
Client Netmask	Set the client subnet netmask to limit the IP address range.
Renegotiation Interval	Renegotiate data channel key after this interval. 0 means disable.
Max Clients	Limit server to a maximum of concurrent clients, range: 1-20. Note: please adjust log severity to Info if you need to connect many clients.
Enable CRL	Enable or disable CRL verify.
Enable Client to Client	When enabled, openVPN clients can communicate with each other.
Enable Dup Client	Allow multiple clients to connect with the same common name or certification.
Enable TLS Authentication	Select from None, TLS Auth and TLS Crypt. When selecting TLS Auth or TLS Crypt, go to Network > VPN > Certifications page to import a ta.key.
Compression	Select to enable or disable LZO to compress data.
Link Detection Interval (s)	Set link detection interval time to ensure tunnel connection. If this is set on both server and client, the value pushed from server will override the client local values. Range: 10-1800 s.
Link Detection Timeout (s)	OpenVPN will be reestablished after timeout. If this is set on both server and client, the value pushed from server will override the client local values. Range: 60-3600 s.
Cipher	Select from NONE, BF-CBC, DES-CBC, DES-EDE3-CBC, AES-128-CBC, AES-192-CBC and AES-256-CBC.
Authentication Mode	Select from NONE, MD5, SHA1, SHA256, and SHA512.
MTU	Enter the maximum transmission unit. Range: 64-1500.
Max Frame Size	Set the maximum frame size. Range: 64-1500.
Verbose Level	Select from ERROR, WARING, NOTICE and DEBUG.
Expert Options	User can enter some initialization strings in this field and separate the strings with semicolon.

	Example: ncp-ciphers AES-128-GCM; key direction 1
Account	
Username & Password	Set username and password for OpenVPN client when authentication type is username/password.
Local Route	
Subnet	Set the local route's IP address.
Subnet Mask	Set the local route's netmask.
Client Subnet	
Name	Set the name as OpenVPN client certificate common name.
Subnet	Set the subnet of OpenVPN client.
Subnet Mask	Set the subnet netmask of OpenVPN client.

Table 3-2-5-14 OpenVPN Server Parameters

3.2.5.9 Certifications

User can import/export certificate and key files for OpenVPN and IPsec on this page.

OpenVPN Client

— OpenVPN Client_1

CA	<input type="text"/>	Browse	Import	Export	Delete
Public Certificate	<input type="text"/>	Browse	Import	Export	Delete
Private Key	<input type="text"/>	Browse	Import	Export	Delete
TA	<input type="text"/>	Browse	Import	Export	Delete
TLS Crypt	<input type="text"/>	Browse	Import	Export	Delete
Preshared Key	<input type="text"/>	Browse	Import	Export	Delete
PKCS12	<input type="text"/>	Browse	Import	Export	Delete

+ OpenVPN Client_2

+ OpenVPN Client_3

Figure 3-2-5-17

— OpenVPN Server

CA	<input type="text"/>	Browse	Import	Export	Delete
Public Certificate	<input type="text"/>	Browse	Import	Export	Delete
Private Key	<input type="text"/>	Browse	Import	Export	Delete
DH	<input type="text"/>	Browse	Import	Export	Delete
TA	<input type="text"/>	Browse	Import	Export	Delete
TLS Crypt	<input type="text"/>	Browse	Import	Export	Delete
CRL	<input type="text"/>	Browse	Import	Export	Delete
Preshared Key	<input type="text"/>	Browse	Import	Export	Delete

Figure 3-2-5-18

IPsec

— IPsec_1

CA	<input type="text"/>	Browse	Import	Export	Delete
Local Certificate	<input type="text"/>	Browse	Import	Export	Delete
Remote Certificate	<input type="text"/>	Browse	Import	Export	Delete
Private Key	<input type="text"/>	Browse	Import	Export	Delete
CRL	<input type="text"/>	Browse	Import	Export	Delete

+ IPsec_2

+ IPsec_3

Figure 3-2-5-19

IPsec Server

— IPsec Server

CA	<input type="text"/>	Browse	Import	Export	Delete
Local Certificate	<input type="text"/>	Browse	Import	Export	Delete
Private Key	<input type="text"/>	Browse	Import	Export	Delete
CRL	<input type="text"/>	Browse	Import	Export	Delete

Figure 3-2-5-20

3.2.6 IP Passthrough

IP Passthrough mode shares or "passes" the Internet providers assigned IP address to a single LAN

client device connected to the router.

Figure 3-2-6-1

IP Passthrough	
Item	Description
Enable	Enable or disable IP Passthrough.
Passthrough Mode	Select passthrough mode from DHCP-S-Fixed and DHCP-S-Dynamic.
MAC	Set MAC address when mode is DHCP-S-Fixed.

Table 3-2-6-1 IP Passthrough Parameters

3.2.7 Routing

3.2.7.1 Static Routing

A static routing is a manually configured routing entry. Information about the routing is manually entered rather than obtained from dynamic routing traffic. After setting static routing, the package for the specified destination will be forwarded to the path designated by user.

Figure 3-2-7-1

Static Routing	
Item	Description
Destination	Enter the destination IP address.
Netmask/Prefix Length	Enter the subnet mask or prefix length of destination address.
Interface	The interface through which the data can reach the destination address.

Gateway	IP address of the next router that will be passed by before the input data reaches the destination address.
Distance	Priority, smaller value refers to higher priority. Range: 1-255.

Table 3-2-7-1 Static Routing Parameters

3.2.7.2 RIP

RIP is mainly designed for small networks. RIP uses Hop Count to measure the distance to the destination address, which is called Metric. In RIP, the hop count from the router to its directly connected network is 0 and the hop count of network to be reached through a router is 1 and so on. In order to limit the convergence time, the specified metric of RIP is an integer in the range of 0 - 15 and the hop count larger than or equal to 16 is defined as infinity, which means that the destination network or host is unreachable. Because of this limitation, the RIP is not suitable for large-scale networks. To improve performance and prevent routing loops, RIP supports split horizon function. RIP also introduces routing obtained by other routing protocols.

Each router that runs RIP manages a routing database, which contains routing entries to reach all reachable destinations.

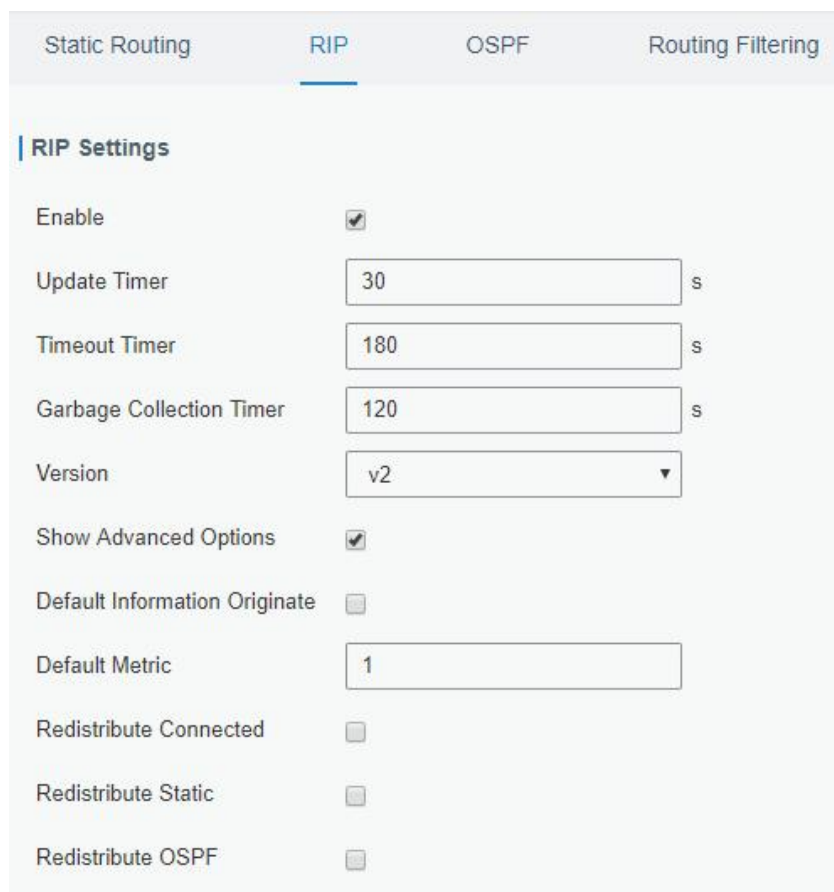

Item	Description
Enable	<input checked="" type="checkbox"/>
Update Timer	30 s
Timeout Timer	180 s
Garbage Collection Timer	120 s
Version	v2
Show Advanced Options	<input checked="" type="checkbox"/>
Default Information Originate	<input type="checkbox"/>
Default Metric	1
Redistribute Connected	<input type="checkbox"/>
Redistribute Static	<input type="checkbox"/>
Redistribute OSPF	<input type="checkbox"/>

Figure 3-2-7-2

RIP	
Item	Description

Enable	Enable or disable RIP.
Update Timer	It defines the interval to send routing updates. Range: 5-2147483647, in seconds.
Timeout Timer	It defines the routing aging time. If no update package on a routing is received within the aging time, the routing's Routing Cost in the routing table will be set to 16. Range: 5-2147483647, in seconds.
Garbage Collection Timer	It defines the period from the routing cost of a routing becomes 16 to it is deleted from the routing table. In the time of Garbage-Collection, RIP uses 16 as the routing cost for sending routing updates. If Garbage Collection times out and the routing still has not been updated, the routing will be completely removed from the routing table. Range: 5-2147483647, in seconds.
Version	RIP version. The options are v1 and v2.
Advanced Settings	
Default Information Originate	Default information will be released when this function is enabled.
Default Metric	The default cost for the router to reach destination. Range: 0-16
Redistribute Connected	Check to enable.
Metric	Set metric after "Redistribute Connected" is enabled. Range: 0-16.
Redistribute Static	Check to enable.
Metric	Set metric after "Redistribute Static" is enabled. Range: 0-16.
Redistribute OSPF	Check to enable.
Metric	Set metric after "Redistribute OSPF" is enabled. Range: 0-16.

Table 3-2-7-2 RIP Parameters

Distance/Metric Management							
Distance	IP Address	Netmask	ACL Name	Operation			
				+			
Metric	Policy In/Out	Interface	ACL Name	Operation			
				+			
Filter Policy							
Policy Type	Policy Name	Policy In/Out	Interface	Operation			
				+			
Passive Interface							
			Passive Interface	Operation			
				+			
Interface							
Interface	Send Version	Receive Version	Split-Horizon	Authentication Mode	Authentication String	Authentication Key-chain	Operation
							+
Neighbor							
				IP Address			Operation
							+
Network							
				IP Address	Netmask		Operation
							+

Figure 3-2-7-3

Item	Description
Distance/Metric Management	
Distance	Set the administrative distance that a RIP route learns. Range: 1-255.
IP Address	Set the IP address of RIP route.
Netmask	Set the netmask of RIP route.
ACL Name	Set ACL name of RIP route.
Metric	The metric of received route or sent route from the interface. Range: 0-16.
Policy in/out	Select from "in" and "out".

Interface	Select interface of the route.
ACL Name	Access control list name of the route strategy.
Filter Policy	
Policy Type	Select from "access-list" and "prefix-list".
Policy Name	User-defined prefix-list name.
Policy in/out	Select from "in" and "out".
Interface	Select interface from "cellular0", "LAN1/WAN" and "Bridge0".
Passive Interface	
Passive Interface	Select interface from "cellular0" and "LAN1/WAN", "Bridge0".
Interface	
Interface	Select interface from "cellular0", "LAN1/WAN" and "Bridge0".
Send Version	Select from "default", "v1" and "v2".
Receive Version	Select from "default", "v1" and "v2".
Split-Horizon	Select from "enable" and "disable".
Authentication Mode	Select from "text" and "md5".
Authentication String	The authentication key for package interaction in RIPV2.
Authentication Key-chain	The authentication key-chain for package interaction in RIPV2.
Neighbor	
IP Address	Set RIP neighbor's IP address manually.
Network	
IP Address	The IP address of interface for RIP publishing.
Netmask	The netmask of interface for RIP publishing.

Table 3-2-7-3

3.2.7.3 OSPF

OSPF, short for Open Shortest Path First, is a link status based on interior gateway protocol developed by IETF.

If a router wants to run the OSPF protocol, there should be a Router ID that can be manually configured. If no Router ID configured, the system will automatically select an IP address of interface as the Router ID. The selection order is as follows:

- If a Loopback interface address is configured, then the last configured IP address of Loopback interface will be used as the Router ID;
- If no Loopback interface address is configured, the system will choose the interface with the biggest IP address as the Router ID.

Five types of packets of OSPF:

- **Hello packet**

- **DD packet** (Database Description Packet)
- **LSR packet** (Link-State Request Packet)
- **LSU packet** (Link-State Update Packet)
- **LSAck packet** (Link-Sate Acknowledgment Packet)

Neighbor and Neighboring

After OSPF router starts up, it will send out Hello Packets through the OSPF interface. Upon receipt of Hello packet, OSPF router will check the parameters defined in the packet. If it's consistent, a neighbor relationship will be formed. Not all matched sides in neighbor relationship can form the adjacency relationship. It is determined by the network type. Only when both sides successfully exchange DD packets and LSDB synchronization is achieved, the adjacency in the true sense can be formed. LSA describes the network topology around a router, LSDB describes entire network topology.

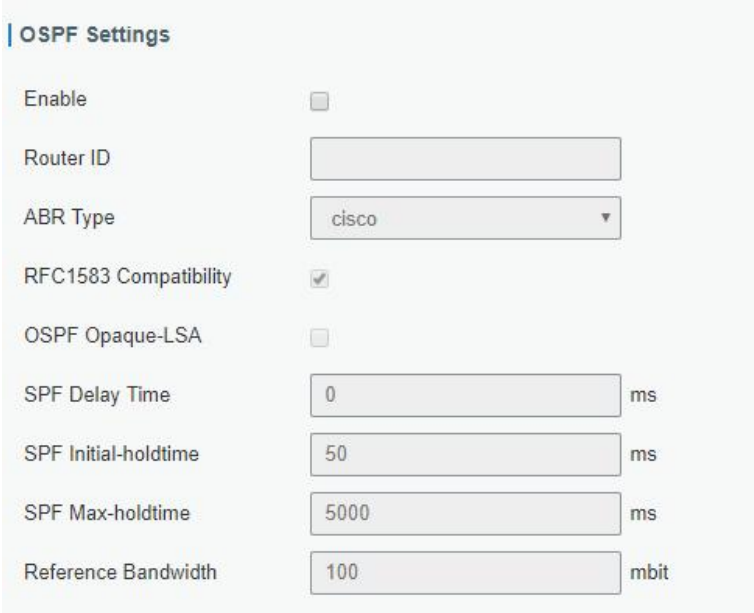

Figure 3-2-7-4

OSPF	
Item	Description
Enable	Enable or disable OSPF.
Router ID	Router ID (IP address) of the originating LSA.
ABR Type	Select from cisco, ibm, standard and shortcut.
RFC1583 Compatibility	Enable/Disable.
OSPF Opaque-LSA	Enable/Disable LSA: a basic communication means of the OSPF routing protocol for the Internet Protocol (IP).
SPF Delay Time	Set the delay time for OSPF SPF calculations. Range: 0-6000000, in milliseconds.

SPF Initial-holdtime	Set the initialization time of OSPF SPF. Range: 0-6000000, in milliseconds.
SPF Max-holdtime	Set the maximum time of OSPF SPF. Range: 0-6000000, in milliseconds.
Reference Bandwidth	Range: 1-4294967, in Mbit.

Table 3-2-7-4 OSPF Parameters

Interface

Interface	Hello Interval(s)	Dead Interval(s)	Retransmit Interval(s)	Transmit Delay(s)	Operation
Bridge0	10	40	5	1	<input type="button" value="X"/> <input type="button" value="+"/>

Interface Advanced Options

Interface	Network	Cost	Priority	Authentication	Key ID	Key	Operation
Bridge	broad	10	1				<input type="button" value="X"/> <input type="button" value="+"/>

Figure 3-2-7-5

Item	Description
Interface	
Interface	Select interface from "cellular0", "WAN" and "Bridge0".
Hello Interval (s)	Send interval of Hello packet. If the Hello time between two adjacent routers is different, the neighbour relationship cannot be established. Range: 1-65535.
Dead Interval (s)	Dead Time. If no Hello packet is received from the neighbours within the dead time, then the neighbour is considered failed. If dead times of two adjacent routers are different, the neighbour relationship cannot be established.
Retransmit Interval (s)	When the router notifies an LSA to its neighbour, it is required to make acknowledgement. If no acknowledgement packet is received within the retransmission interval, this LSA will be retransmitted to the neighbour. Range: 3-65535.
Transmit Delay (s)	It will take time to transmit OSPF packets on the link. So a certain delay time should be increased before transmission the aging time of LSA. This configuration needs to be further considered on the low-speed link. Range: 1-65535.
Interface Advanced Options	
Interface	Select interface.
Network	Select OSPF network type.
Cost	Set the cost of running OSPF on an interface. Range: 1-65535.
Priority	Set the OSPF priority of interface. Range: 0-255.
Authentication	Set the authentication mode that will be used by the OSPF area.

	Simple: a simple authentication password should be configured and confirmed again. MD5: MD5 key & password should be configured and confirmed again.
Key ID	It only takes effect when MD5 is selected. Range 1-255.
Key	The authentication key for OSPF packet interaction.

Table 3-2-7-5 OSPF Parameters

The screenshot shows a configuration interface with four main sections, each containing a table of fields and an 'Add' (+) button:

- Passive Interface:** A table with one column 'Passive Interface' and one column 'Operation'.
- Network:** A table with four columns: 'IP Address', 'Netmask', 'Area ID', and 'Operation'.
- Neighbor:** A table with four columns: 'IP Address', 'Priority', 'Poll', and 'Operation'.
- Area:** A table with five columns: 'Area ID', 'Area', 'No Summary', 'Authentication', and 'Operation'.

Figure 3-2-7-6

Item	Description
Passive Interface	
Passive Interface	Select interface from "cellular0", "LAN1/WAN" and "Bridge0".
Network	
IP Address	The IP address of local network.
Netmask	The netmask of local network.
Area ID	The area ID of original LSA's router.
Area	
Area ID	Set the ID of the OSPF area (IP address).
Area	Select from "Stub" and "NSSA". The backbone area (area ID 0.0.0.0) cannot be set as "Stub" or "NSSA".
No Summary	Forbid route summarization.
Authentication	Select authentication from "simple" and "md5".

Table 3-2--7-6 OSPF Parameters

Area Advanced Options

Area Range

Area ID	IP Address	Netmask	No Advertise	Cost	Operation
					+

Area Filter

Area ID	Filter Type	ACL Name	Operation
			+

Area Virtual Link

Area ID	ABR Address	Authentication	Key ID	Key	Hello Interval	Dead Interval	Retransmit Interval	Transmit Delay	Operation
									+

Figure 3-2-7-7

Area Advanced Options	
Item	Description
Area Range	
Area ID	The area ID of the interface when it runs OSPF (IP address).
IP Address	Set the IP address.
Netmask	Set the netmask.
No Advertise	Forbid the route information to be advertised among different areas.
Cost	Range: 0-16777215
Area Filter	
Area ID	Select an Area ID for Area Filter.
Filter Type	Select from "import", "export", "filter-in", and "filter-out".
ACL Name	Enter an ACL name which is set on "Routing > Routing Filtering" webpage.
Area Virtual Link	
Area ID	Set the ID number of OSPF area.
ABR Address	ABR is the router connected to multiple outer areas.
Authentication	Select from "simple" and "md5".
Key ID	It only takes effect when MD5 is selected. Range 1-15.
Key	The authentication key for OSPF packet interaction.
Hello Interval	Set the interval time for sending Hello packets through the interface. Range: 1-65535.
Dead Interval	The dead interval time for sending Hello packets through the interface. Range: 1-65535.
Retransmit Interval	The retransmission interval time for re-sending LSA. Range: 1-65535.
Transmit Delay	The delay time for LSA transmission. Range: 1-65535.

Table 3-2-7-7 OSPF Parameters

Redistribution

Redistribution Type	Metric	Metric Type	Route Map	Operation
connected		1		<input type="checkbox"/>
				<input type="checkbox"/>

Redistribution Advanced Options

Always Redistribute Default Route

Redistribute Default Route Metric:

Redistribute Default Route Metric Type:

Distance Management

Area Type	Distance	Operation
		<input type="checkbox"/>

Figure 3-2-7-8

Item	Description
Redistribution	
Redistribution Type	Select from "connected", "static" and "rip".
Metric	The metric of redistribution router. Range: 0-16777214.
Metric Type	Select Metric type from "1" and "2".
Route Map	Mainly used to manage route for redistribution.
Redistribution Advanced Options	
Always Redistribute Default Route	Send redistribution default route after starting up.
Redistribute Default Route Metric	Send redistribution default route metric. Range: 0-16777214.
Redistribute Default Route Metric Type	Select from "0", "1" and "2".
Distance Management	
Area Type	Select from "intra-area", "inter-area" and "external".
Distance	Set the OSPF routing distance for area learning. Range: 1-255.

Table 3-2-7-8 OSPF Parameters

3.2.7.4 Routing Filtering

Figure 3-2-7-9

Routing Filtering	
Item	Description
Access Control List	
Name	User-defined name, need to start with a letter. Only letters, digits and underline (_) are allowed.
Action	Select from "permit" and "deny".
Match Any	No need to set IP address and subnet mask.
IP Address	User-defined.
Netmask	User-defined.
IP Prefix-List	
Name	User-defined name, need to start with a letter. Only letters, digits and underline (_) are allowed.
Sequence Number	A prefix name list can be matched with multiple rules. One rule is matched with one sequence number. Range: 1-4294967295.
Action	Select from "permit" and "deny".
Match Any	No need to set IP address, subnet mask, FE Length, and LE Length.
IP Address	User-defined.
Netmask	User-defined.
FE Length	Specify the minimum number of mask bits that must be matched. Range: 0-32.
LE Length	Specify the maximum number of mask bits that must be matched. Range: 0-32.

Table 3-2-7-9 Routing Filtering Parameters

3.2.8 VRRP

The Virtual Router Redundancy Protocol (VRRP) is a computer networking protocol that provides automatic assignment of available Internet Protocol (IP) routers for participating hosts. This increases the availability and reliability of routing paths via automatic default gateway selections in an IP sub-network.

Increasing the number of exit gateway is a common method for improving system reliability. VRRP adds a group of routers that undertake gateway function into a backup group so as to form a virtual router. The election mechanism of VRRP will decide which router undertakes the forwarding task, and

the host in LAN is only required to configure the default gateway for the virtual router.

In VRRP, routers need to be aware of failures in the virtual master router. To achieve this, the virtual master router sends out multicast “alive” announcements to the virtual backup routers in the same VRRP group.

The VRRP router who has the highest number will become the virtual master router. The VRRP router number ranges from 1 to 255 and usually we use 255 for the highest priority and 100 for backup.

If the current virtual master router receives an announcement from a group member (Router ID) with a higher priority, then the latter will pre-empt and become the virtual master router.

VRRP has the following characteristics:

- The virtual router with an IP address is known as the Virtual IP address. For the host in LAN, it is only required to know the IP address of virtual router, and set it as the address of the next hop of the default route.
- The network Host communicates with the external network through this virtual router.
- A router will be selected from the set of routers based on its priority to undertake the gateway function. Other routers will be used as backup routers to perform the duties of gateway for the gateway router in the case of any malfunction, so as to guarantee uninterrupted communication between the host and external network.

When interface connected with the uplink is at the state of Down or Removed, the router actively lowers its priority so that priority of other routers in the backup group will be higher. Thus the router with the highest priority becomes the gateway for the transmission task.

Figure 3-2-8-1

VRRP		
Item	Description	Default
Enable	Enable or disable VRRP.	Disable
Interface	Select the interface of Virtual Router.	None

Virtual Router ID	User-defined Virtual Router ID. Range: 1-255.	None
Virtual IP	Set the IP address of Virtual Router.	None
Priority	The VRRP priority range is 1-254 (a bigger number indicates a higher priority). The router with higher priority will be more likely to become the gateway router.	100
Advertisement Interval (s)	Heartbeat package transmission time interval between routers in the virtual ip group. Range: 1-255.	1
Preemption Mode	If the router works in the preemption mode, once it finds that its own priority is higher than that of the current gateway router, it will send VRRP notification package, resulting in re-election of gateway router and eventually replacing the original gateway router. Accordingly, the original gateway router will become a Backup router.	Disable
IPV4 Primary Server	The router will send ICMP packet to the IP address or host name to determine whether the Internet connection is still available or not.	8.8.8.8
IPV4 Secondary Server	The router will try to ping the secondary server name if primary server is not available.	114.114. 114.114
Interval	Time interval (in seconds) between two Pings.	300
Retry Interval	Set the ping retry interval. When ping failed, the router will ping again every retry interval.	5
Timeout	The maximum amount of time the router will wait for a response to a ping request. If it does not receive a response for the amount of time defined in this field, the ping request will be considered as failure.	3
Max Ping Retries	The retry times of the router sending ping request until determining that the connection has failed.	3

Table 3-2-8-1 VRRP Parameters

Related Configuration Example

[VRRP Application Example](#)

3.2.9 DDNS

Dynamic DNS (DDNS) is a method that automatically updates a name server in the Domain Name System, which allows user to alias a dynamic IP address to a static domain name.

DDNS serves as a client tool and needs to coordinate with DDNS server. Before starting configuration, user shall register on a website of proper domain name provider and apply for a domain name.

Figure 3-2-9-1

DDNS	
Item	Description
Enable	Enable/disable DDNS.
Name	Give the DDNS a descriptive name.
Interface	Set interface bundled with the DDNS.
Service Type	Select the DDNS service provider.
Username	Enter the username for DDNS register.
User ID	Enter User ID of the custom DDNS server.
Password	Enter the password for DDNS register.
Server	Enter the name of DDNS server.
Server Path	By default the hostname is appended to the path.
Hostname	Enter the hostname for DDNS.
Append IP	Append your current IP to the DDNS server update path.
Use HTTPS	Enable HTTPS for some DDNS providers.

Table 3-2-9-1 DDNS Parameters

3.3 System

3.3.1 General Settings

3.3.1.1 General

General settings include system info and HTTPS certificates.

The screenshot shows a web-based configuration interface for a Milesight router. It is divided into two main sections: 'System' and 'HTTPS Certificates'.
 In the 'System' section, there are three settings:
 - 'Hostname' is set to 'ROUTER' in a text input field.
 - 'Web Login Timeout(s)' is set to '1800' in a text input field.
 - 'Encrypting Cleartext Passwords' is a checkbox that is checked.
 In the 'HTTPS Certificates' section, there are two rows of settings:
 - 'Certificate' with a text input field containing 'https.crt' and four buttons: 'Browse', 'Import', 'Export', and 'Delete'.
 - 'Key' with a text input field containing 'https.key' and four buttons: 'Browse', 'Import', 'Export', and 'Delete'.
 At the bottom of the form is a large blue 'Save' button.

Figure 3-3-1-1

General		
Item	Description	Default
System		
Hostname	User-defined router name, needs to start with a letter.	ROUTER
Web Login Timeout (s)	You need to log in again if it times out. Range: 100-3600.	1800
Encrypting Cleartext Passwords	This function will encrypt all of cleartext passwords into ciphertext passwords.	Enable
HTTPS Certificates		
Certificate	Click "Browse" button, choose certificate file on the PC, and then click "Import" button to upload the file into router. Click "Export" button will export the file to the PC. Click "Delete" button will delete the file.	--
Key	Click "Browse" button, choose key file on the PC, and then click "Import" button to upload the file into router. Click "Export" button will export file to the PC. Click "Delete" button will delete the file.	--

Table 3-3-1-1 General Setting Parameters

3.3.1.2 System Time

This section explains how to set the system time including time zone and time synchronization type.

Note: to ensure that the router runs with the correct time, it's recommended that you set the system

time when configuring the router.

The screenshot displays the 'System Time Settings' configuration interface. It includes the following elements:

- System Time Settings:**
 - Current Time: 2020-04-30 17:58:27 Thur
 - Time Zone: 8 China (Beijing)
 - Sync Type: Sync with NTP Server
 - Primary NTP Server: 1.cn.pool.ntp.org
 - Secondary NTP Server: (empty)
- NTP Server:**
 - Enable NTP Server:
- A blue 'Save' button is located at the bottom left.

Figure 3-3-1-2

System Time	
Item	Description
Current Time	Show the current system time.
Time Zone	Click the drop down list to select the time zone you are in.
Sync Type	Click the drop down list to select the time synchronization type. Sync with Browser: Synchronize time with browser. Sync with NTP Server: Synchronize time with NTP Server. Set up Manually: configure the time manually. GPS Time Synchronization: Synchronize time with GPS per hour. This is only applicable with GPS version and ensure that GPS is enabled on Service > GPS > GPS .
Sync with Browser	Synchronize time with browser.
Browser Time	Show the current time of browser.
Set up Manually	Manually configure the system time.
GPS Time Synchronization	Synchronize time with GPS.
Primary NTP Server	Enter primary NTP Server's IP address or domain name.
Secondary NTP Server	Enter secondary NTP Server's IP address or domain name.
NTP Server	
Enable NTP Server	NTP client on the network can achieve time synchronization with router after this option is checked.

Table 3-3-1-2 System Time Parameters

3.3.1.3 Email

SMTP, short for Simple Mail Transfer Protocol, is a TCP/IP protocol used in sending and receiving e-mail. This section describes how to configure email settings and add email groups for alarms and events.

The screenshot shows the 'SMTP Client Settings' configuration interface. It includes a title bar, a list of settings with their current values, and a 'Test' button at the bottom.

Setting	Value
Enable	<input checked="" type="checkbox"/>
Email Address	<input type="text"/>
Password	<input type="text"/>
SMTP Server Address	<input type="text"/>
Port	25
Encryption	STARTTLS

Figure 3-3-1-3

SMTP Client Settings	
Item	Description
Enable	Enable or disable SMTP client function.
Email Address	Enter the sender's email account.
Password	Enter the sender's email password.
SMTP Server Address	Enter SMTP server's domain name.
Port	Enter SMTP server port. Range: 1-65535.
Encryption	<p>Select from: None, TLS/SSL, STARTTLS.</p> <p>None: No encryption. The default port is 25.</p> <p>STARTTLS: STARTTLS is a way to take an existing insecure connection and upgrade it to a secure connection by using SSL/TLS. The default port is 587.</p> <p>TLS/SSL: SSL and TLS both provide a way to encrypt a communication channel between two computers (e.g. your computer and our server). TLS is the successor to SSL and the terms SSL and TLS are used interchangeably unless you're referring to a specific version of the protocol. The default port is 465.</p>

Table 3-3-1-3 SMTP Setting

The screenshot displays two configuration sections. The 'Email List' section features a table with columns for 'Email Address', 'Description', and 'Operation'. Below the table are input fields for 'Email Address' and 'Description', and a 'Save' button. The 'Email Group List' section includes input fields for 'Group ID' and 'Description', two list boxes labeled 'List' and 'Selected', and navigation arrows between them. At the bottom are 'Save' and 'Cancel' buttons.

Figure 3-3-1-4

Item	Description
Email List	
Email Address	Enter the Email address.
Description	The description of the Email address.
Email Group List	
Group ID	Set number for email group. Range: 1-100.
Description	The description of the Email group.
List	Show the Email address list.
Selected	Show the selected Email address.

Table 3-3-1-4 Email Settings

Related Topics

[DI Setting](#)

[Events Setting](#)

3.3.1.4 Storage

You can view Micro SD card information on this page.

The 'Micro SD' configuration page shows the following information:

- Status: Available
- Storage (Capacity/Available): 7.2G/6.8G(1%)
- A 'Format' button is located at the bottom.

Figure 3-3-1-5

Storage	
Item	Description
Status	Show the status of Micro SD card, such as "Available" or "Not Inserted".
Storage (Capacity/Available)	The total capacity of the Micro SD Card.
Format	Format the Micro SD card.

Table 3-3-1-5 Storage Information

3.3.2 Phone&SMS

3.3.2.1 Phone

Phone settings involve in call/SMS trigger, SMS control and SMS alarm for events.

Figure 3-3-2-1

Phone	
Item	Description
Phone Number List	
Number	Enter the telephone number. Digits, "+" and "-" are allowed.
Description	The description of the telephone number.
Phone Group List	
Group ID	Set number for phone group. Range: 1-100.
Description	The description of the phone group.
List	Show the phone list.
Selected	Show the selected phone number.

Table 3-3-2-1 Phone Settings

Related Topic

[Connect on Demand](#)

3.3.2.2 SMS

SMS settings involve in remote SMS control, sending SMS and SMS receiving and sending status. Ensure the SMS center number is typed on **Network > Interface > Cellular** page before using SMS features.

Figure 3-3-2-2

SMS Settings	
Item	Description
SMS Mode	Select SMS mode: Text: Pure text mode, mainly used in Europe and America. Technically, it can also be used to send Short Messages in Chinese. When CLI commands will be sent to control the router, Text mode is recommended to choose. PDU: It's the default encoding Mode for mobile phones, which conform to all mobile phones SMS format and can use any character.
SMS Remote Control	Enable/disable SMS Remote Control to send SMS to control the router.
Authentication Type	You can choose "phone number" or "password + phone number". Phone number: only the phone numbers on phone groups support remote control. Password + phone number: only the phone numbers on phone groups support remote control; besides, control SMS should be sent as format password+";"+command content.
Password	Set password for authentication.
Phone Group	Select the Phone group which used for remote control. User can click the Phone Group and set phone number.

Table 3-3-2-2 SMS Remote Control Parameters

The screenshot displays the Milesight web interface for SMS management. It is divided into three main sections: 'Send SMS', 'Inbox', and 'Outbox'.
 - **Send SMS:** Contains two input fields labeled 'Phone Number' and 'Content', followed by a blue 'Send' button.
 - **Inbox:** Features input fields for 'From', 'To', and 'Sender', along with 'Search' and 'Clear All' buttons. Below is a table with columns 'Sender', 'Time', and 'Content'. A pagination control shows page 1 of 10, with a 'Go to:' field and a 'GO' button.
 - **Outbox:** Features input fields for 'From', 'To', and 'Recipient', along with 'Search' and 'Clear All' buttons. Below is a table with columns 'Recipient', 'Time', 'Content', and 'Status'. A pagination control shows page 1 of 10, with a 'Go to:' field and a 'GO' button.

Figure 3-3-2-3

SMS	
Item	Description
Send SMS	
Phone Number	Enter the number to receive the SMS.
Content	SMS content.
Inbox/Outbox	
Sender	SMS sender from outside.
Recipient	SMS recipient which UR32 send to.
From	Select the start date.
To	Select the end date.
Search	Search for SMS record.
Clear All	Clear all SMS records in web GUI.

Table 3-3-2-3 SMS Settings

3.3.3 User Management

3.3.3.1 Account

Here you can change the login username and password of the administrator.

Note: it is strongly recommended that you modify them for the sake of security.

The screenshot shows a web interface for 'User Management' with a sub-section for 'Change Account Info'. It contains four text input fields: 'Username' (with 'admin' entered), 'Old Password', 'New Password', and 'Confirm New Password'. A blue 'Save' button is located at the bottom left of the form area.

Figure 3-3-3-1

Account	
Item	Description
Username	Enter a new username. You can use characters such as a-z, 0-9, "_", "-". The first character can't be a digit.
Old Password	Enter the old password.
New Password	Enter a new password.
Confirm New Password	Enter the new password again.

Table 3-3-3-1 Account Settings

3.3.3.2 User Management

This section describes how to create common user accounts. The common user permission includes Read-Only and Read-Write.

The screenshot shows a 'User List' table with four columns: 'Username', 'Password', 'Permission', and 'Operation'. The first row contains empty input boxes for 'Username' and 'Password', a dropdown menu for 'Permission' currently showing 'Read-Only', and a blue 'X' icon in the 'Operation' column. A blue '+' icon is located below the table.

Figure 3-3-3-2

User Management	
Item	Description
Username	Enter a new username. You can use characters such as a-z, 0-9, "_", "-". The first character can't be a digit.
Password	Set password.
Permission	Select user permission from "Read-Only" and "Read-Write". Read-Only: users can only view the configuration of router in this level. Read-Write: users can view and set the configuration of router in this level.

Table 3-3-3-2 User Management

3.3.4 AAA

AAA access control is used for visitors control and the available corresponding services once access

is allowed. It adopts the same method to configure three independent safety functions. It provides modularization methods for following services:

- Authentication: verify if the user is qualified to access to the network.
- Authorization: authorize related services available for the user.
- Charging: record the utilization of network resources.

3.3.4.1 Radius

Using UDP for its transport, Radius is generally applied in various network environments with higher requirements of security and permission of remote user access.

Figure 3-3-4-1

Radius	
Item	Description
Enable	Enable or disable Radius.
Server IP Address	Fill in the Radius server IP address/domain name.
Server Port	Fill in the Radius server port. Range: 1-65535.
Key	Fill in the key consistent with that of Radius server in order to get connected with Radius server.

Table 3-3-4-1 Radius Parameters

3.3.4.2 TACACS+

Using TCP for its transport, TACACS+ is mainly used for authentication, authorization and charging of the access users and terminal users by adopting PPP and VPDN.

Figure 3-3-4-2

TACACS+	
Item	Description
Enable	Enable or disable TACACS+.
Server IP Address	Fill in the TACACS+ server IP address/domain name.
Server Port	Fill in the TACACS+ server port. Range: 1-65535.
Key	Fill in the key consistent with that of TACACS+ server in order to get connected with TACACS+ server.

Table 3-3-4-2 TACACS+ Parameters

3.3.4.3 LDAP

A common usage of LDAP is to provide a central place to store usernames and passwords. This allows many different applications and services to connect the LDAP server to validate users.

LDAP is based on a simpler subset of the standards contained within the [X.500](#) standard. Because of this relationship, LDAP is sometimes called X.500-lite as well.

The screenshot shows the LDAP Settings configuration page. It includes a 'Save' button at the bottom. The settings are as follows:

Setting	Value
Enable	<input checked="" type="checkbox"/>
Server IP Address	<input type="text"/>
Server Port	389
Base DN	<input type="text"/>
Security	None
Username	<input type="text"/>
Password	<input type="text"/>

Figure 3-3-4-3

LDAP	
Item	Description
Enable	Enable or Disable LDAP.
Server IP Address	Fill in the LDAP server's IP address/domain name. The maximum count is 10.
Server Port	Fill in the LDAP server's port. Range: 1-65535
Base DN	The top of LDAP directory tree.
Security	Select secure method from "None", "StartTLS" and "SSL".
Username	Enter the username to access the server.
Password	Enter the password to access the server.

Table 3-3-5-3 LDAP Parameters

3.3.4.4 Authentication

AAA supports the following authentication ways:

- None: uses no authentication, generally not recommended.
- Local: uses the local username database for authentication.
 - Advantages: rapidness, cost reduction.
 - Disadvantages: storage capacity limited by hardware.
- Remote: has user's information stored on authentication server. Radius, TACACS+ and LDAP supported for remote authentication.

When radius, TACACS+, and local are configured at the same time, the priority level is: 1 > 2 > 3.

Service	1	2	3
Console	None ▼	None ▼	None ▼
Web	None ▼	None ▼	None ▼
Telnet	None ▼	None ▼	None ▼
SSH	None ▼	None ▼	None ▼

Save

Figure 3-3-4-4

Authentication	
Item	Description
Console	Select authentication for Console access.
Web	Select authentication for Web access.
Telnet	Select authentication for Telnet access.
SSH	Select authentication for SSH access.

Table 3-3-4-4 Authentication Parameters

3.3.5 Device Management

3.3.5.1 DeviceHub

You can connect the device to the Milesight DeviceHub on this page so as to manage the router centrally and remotely. For more details please refer to *DeviceHub User Guide*.

Device Management Milesight VPN

Device Management

Status Disconnected

Server Address

Activation Method By Authentication Code ▼

Authentication Code

Connect

Figure 3-3-5-1

DeviceHub	
Item	Description
Status	Show the connection status between the router and the DeviceHub.
Disconnected	Click this button to disconnect the router from the DeviceHub.
Server Address	IP address or domain of the device management server.
Activation Method	Select activation method to connect the router to the DeviceHub server, options are "By Authentication Code" and "By Account name".
Authentication Code	Fill in the authentication code generated from the DeviceHub.
Account name	Fill in the registered DeviceHub account (email) and password.
Password	

Table 3-3-5-1

3.3.5.2 Milesight VPN

You can connect the device to the Milesight VPN on this page so as to manage the router and connected devices centrally and remotely. For more details please refer to *MilesightVPN User Guide*.

Device Management
Milesight VPN

Milesight VPN Setting

Server	<input style="width: 90%;" type="text"/>
Port	<input style="width: 90%;" type="text" value="18443"/>
Authorization Code	<input style="width: 90%;" type="text"/>
Device Name	<input style="width: 90%;" type="text"/>

[Connect](#)

Milesight VPN Status

Status	Disconnected
Local IP	--
Remote IP	--
Duration	-

Figure 3-3-5-2

Milesight VPN	
Item	Description
Milesight VPN Settings	
Server	Enter the IP address or domain name of Milesight VPN.
Port	Enter the HTTPS port number.
Authorization code	Enter the authorization code which generated by Milesight VPN.
Device Name	Enter the name of the device.
Milesight VPN Status	
Status	Show the connection information about whether the router is connected to the Milesight VPN.
Local IP	Show the virtual IP of the router.
Remote IP	Show the virtual IP of the Milesight VPN.
Duration	Show the information on how long the router has been connected to the Milesight VPN.

Table 3-3-5-2

3.3.6 Events

Event feature is capable of sending alerts by Email when certain system events occur.

3.3.6.1 Events

You can view alarm messages on this page.

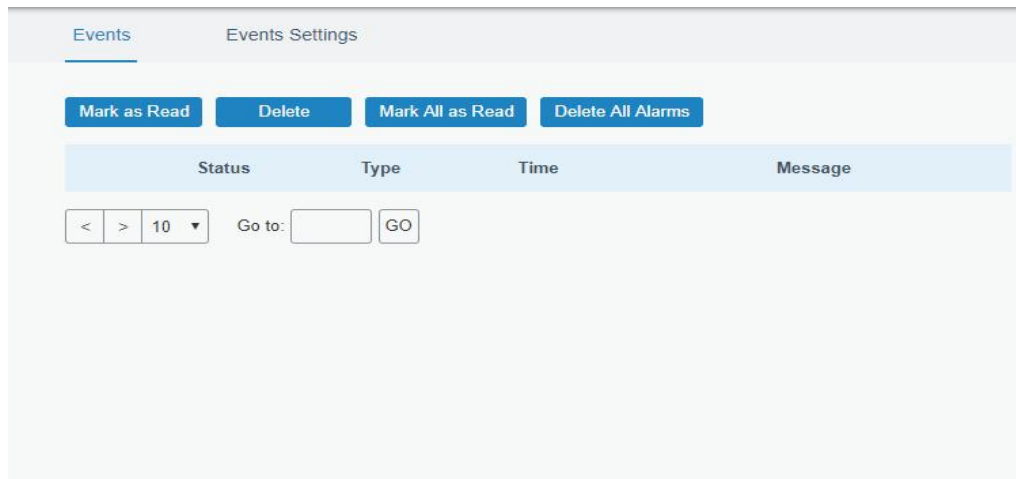

Figure 3-3-6-1

Events	
Item	Description
Mark as Read	Mark the selected event alarm as read.
Delete	Delete the selected event alarm.
Mark All as Read	Mark all event alarms as read.
Delete All Alarms	Delete all event alarms.
Status	Show the reading status of the event alarms, such as "Read" and "Unread".

Type	Show the event type that should be alarmed.
Time	Show the alarm time.
Message	Show the alarm content.

Table 3-3-6-1 Events Parameters

3.3.6.2 Events Settings

In this section, you can decide what events to record and whether you want to receive email and SMS notifications when any change occurs.

Events
Events Settings

Events Settings

Enable

Phone Group List

Email Group List

Events	Record <input type="checkbox"/>	Email <input type="checkbox"/> Email Group List	SMS <input type="checkbox"/> Phone Group List	SNMP <input type="checkbox"/>
System Startup	<input type="checkbox"/>	<input type="checkbox"/>	<input type="checkbox"/>	<input type="checkbox"/>
System Reboot	<input type="checkbox"/>	<input type="checkbox"/>	<input checked="" type="checkbox"/>	<input checked="" type="checkbox"/>
System Time Update	<input type="checkbox"/>	<input type="checkbox"/>	<input checked="" type="checkbox"/>	<input checked="" type="checkbox"/>
VPN Up	<input type="checkbox"/>	<input type="checkbox"/>	<input type="checkbox"/>	<input type="checkbox"/>
VPN Down	<input type="checkbox"/>	<input type="checkbox"/>	<input type="checkbox"/>	<input type="checkbox"/>
WAN Up	<input type="checkbox"/>	<input type="checkbox"/>	<input type="checkbox"/>	<input type="checkbox"/>
WAN Down	<input type="checkbox"/>	<input type="checkbox"/>	<input type="checkbox"/>	<input type="checkbox"/>
Link switch	<input type="checkbox"/>	<input type="checkbox"/>	<input type="checkbox"/>	<input type="checkbox"/>
Weak Signal	<input type="checkbox"/>	<input type="checkbox"/>	<input type="checkbox"/>	<input type="checkbox"/>
Cellular Up	<input type="checkbox"/>	<input type="checkbox"/>	<input type="checkbox"/>	<input type="checkbox"/>

Figure 3-3-6-2

Cellular Down	<input checked="" type="checkbox"/>	<input type="checkbox"/>	<input type="checkbox"/>	<input type="checkbox"/>
Cellular Data Stats Clear	<input type="checkbox"/>	<input type="checkbox"/>	<input type="checkbox"/>	<input type="checkbox"/>
Cellular Data Traffic is running out	<input type="checkbox"/>	<input type="checkbox"/>	<input type="checkbox"/>	<input type="checkbox"/>
Cellular Data Traffic Overflow	<input type="checkbox"/>	<input type="checkbox"/>	<input type="checkbox"/>	<input type="checkbox"/>
WLAN Up(AP)	<input type="checkbox"/>	<input type="checkbox"/>	<input type="checkbox"/>	<input type="checkbox"/>
WLAN Down(AP)	<input type="checkbox"/>	<input type="checkbox"/>	<input type="checkbox"/>	<input type="checkbox"/>
WLAN Up(Client)	<input type="checkbox"/>	<input type="checkbox"/>	<input type="checkbox"/>	<input type="checkbox"/>
WLAN Down(Client)	<input type="checkbox"/>	<input type="checkbox"/>	<input type="checkbox"/>	<input type="checkbox"/>

Figure 3-3-6-3

Event Settings	
Item	Description
Enable	Check to enable "Events Settings".
Phone Group List	Select phone group to receive SMS alarm.
Email Group List	Select email group to receive alarm.
Record	The relevant content of event alarm will be recorded on "Event" page if this option is checked.
Email	The relevant content of event alarm will be sent out via email if this option is checked.
Email Setting	Click and you will be redirected to the page "Email" to configure email group list.
SMS	The relevant content of event alarm will be sent out via SMS if this option is checked.
SMS Setting	Click and you will be redirected to the page of "Phone" to configure phone group list.
VPN Up	VPN is connected.
VPN Down	VPN is disconnected.
WAN Up	Ethernet cable is connected to WAN port.
WAN Down	Ethernet cable is disconnected to WAN port.
Link Switch	Switch to use other interface for Internet access.
Weak Signal	The signal level of cellular is low.
Cellular Up	Cellular network is connected.
Cellular Down	Cellular network is disconnected.
Cellular Data Stats Clear	Zero out the data usage of the main SIM card.
Cellular Data Traffic is running out	The main SIM card is reaching the data usage limit.
Cellular Data Traffic Over Flow	The main SIM card has exceeded the data usage plan.
WLAN Up(AP)	The WLAN(AP) is enabled.
WLAN Down(AP)	The WLAN(AP) has stopped working.
WLAN Up(Client)	The WLAN(Client) is enabled.
WLAN Down(Client)	The WLAN(Client) has stopped working.

Table 3-3-6-2 Events Parameters

Related Topics

[Email Setting](#)

3.4 Service

3.4.1 I/O

3.4.1.1 DI

This section explains how to configure monitoring condition on digital input, and take certain actions

once the condition is reached.

The screenshot shows the 'DI Setting' configuration interface. It includes a 'Save' button and several settings: 'Enable' is checked, 'Mode' is set to 'High Level', 'Duration(ms)' is set to '100', and 'Action' options include 'SMS', 'Email', 'DO', and 'Cellular UP', all of which are currently unchecked.

Figure 3-4-1-1

DI	
Item	Description
Enable	Enable or disable DI.
Mode	Options are High Level, Low Level, and Counter.
Duration (ms)	Set the duration of high/low level in digital input. Range: 1-10000.
Condition	Select the condition to trigger the counter. Low->High: The counter value will increase by 1 if digital input's status changes from low level to high level. High->Low: The counter value will increase by 1 if digital input's status changes from high level to low level.
Counter	The system will take actions accordingly when the counter value reach the preset one, and then reset the counter value to 0. Range: 1-100.
Action	Select the corresponding actions that the system will take when digital input mode meets the preset condition or duration. SMS: enable to send SMS alarms. Email: enable to send Email alarms. DO: control the DO status as settings on Service > I/O > DO page . Cellular UP: Trigger the router to switch from offline to register to cellular network.

Table 3-4-1-1 DI Parameters

Related Topics

[DO Setting](#)

[Email Setting](#)

[Connect on Demand](#)

3.4.1.2 DO

This section describes how to configure digital output mode.

Figure 3-4-1-2

DO	
Item	Description
Enable	Enable or disable DO.
Mode	Select the working mode of DO. High Level: trigger the DO to send high level signal. Low Level: trigger the DO to send low level signal. Pulse: trigger the DO to send pulses. Custom: trigger the DO via SMS on the phone group.
Initial Status	Select the initial status of DO when mode is Custom or Pulse. It is also the initial status when the router restarts.
Duration (*10ms)	When mode is high level or low level, set duration of high/low level on digital output. Range: 1-10000.
Duration of High Level (*10ms)	Set the duration of pulse's high level. Range: 1-10000.
Duration of Low Level (*10ms)	Set the duration of pulse's low level. Range: 1-10000.
The Number of Pulse	Set the quantity of pulse. Range: 1-100.
Phone Group	Select phone group which will be used for I/O configuration. User can click the Phone Group and set phone number.

Table 3-4-1-2 DO Settings

Related Topics

[DI Setting](#)

3.4.2 Serial Port

This section explains how to configure serial port parameters to achieve communication with serial terminals, and configure work mode to achieve communication with the remote data center, so as to achieve two-way communication between serial terminals and remote data center.

Serial

Serial Settings

Enable

Serial Type

Baud Rate

Data Bits

Stop Bits

Parity

Software Flow Control

Serial Mode

Figure 3-4-2-1

Serial Settings	
Item	Description
Enable	Enable or disable serial port function.
Serial Type	For normal model, it's fixed as RS232; for -485 model, select the serial type as RS232 or RS485.
Baud Rate	The range is 300-230400. Same with the baud rate of the connected terminal device.
Data Bits	Options are 8 and 7. Same with the data bits of the connected terminal device.
Stop Bits	Options are 1 and 2. Same with the stop bits of the connected terminal device.
Parity	Options are None, Odd and Even. Same with the parity of the connected terminal device.
Software Flow Control	Enable or disable software flow control.
Serial Mode	Select work mode of the serial port. DTU Mode: the serial port can establish communication with the remote server/client. GPS: go to Service > GPS > GPS Serial Forwarding to configure basic parameters to send GPS data to serial port. Modbus Client: go to Service > Modbus Client to configure basic parameters and channels. Modbus Server: go to Service > Modbus Server to configure basic parameters.

Table 3-4-2-1 Serial Parameters

Serial Mode	DTU Mode									
DTU Protocol	Transparent									
Protocol	TCP									
Keepalive Interval	75	s								
Keepalive Retry Times	9									
Packet Size	1024	Bytes								
Serial Frame Interval	100	ms								
Reconnect Interval	10	s								
Specific Protocol	<input type="checkbox"/>									
Register String										
Destination IP Address										
<table border="1"> <thead> <tr> <th>Server Address</th> <th>Server Port</th> <th>Status</th> <th>Operation</th> </tr> </thead> <tbody> <tr> <td></td> <td></td> <td></td> <td style="text-align: right;">+</td> </tr> </tbody> </table>			Server Address	Server Port	Status	Operation				+
Server Address	Server Port	Status	Operation							
			+							

Figure 3-4-2-2

DTU Mode		
Item	Description	Default
DTU Protocol	Select from below protocols: Transparent: the router is used as TCP/UDP client and transmits data to server transparently. TCP server: the router is used as TCP server to wait for polling data. UDP server: the router is used as UDP server to wait for polling data. Modbus: the router will be used as Modbus gateway, which can achieve conversion between Modbus RTU and Modbus TCP. MQTT: the router will be used as MQTT client to send data to MQTT broker.	--
TCP/UDP Server		
Listening port	Set the router listening port. Range: 1-65535.	502
Keepalive Interval	After TCP connection is established, client will send heartbeat packet regularly by TCP to keep alive. The interval range is 1-3600s.	75
Keepalive Retry Times	When TCP heartbeat times out, router will resend heartbeat. After it reaches the preset retry times, TCP connection will be reestablished. The retry times range is 1-16.	9
Packet Size	Set the size of the serial data frame. Packet will be sent out when preset frame size is reached. The size range is 1-1024 bytes.	1024
Serial Frame Interval	The interval that the router sends out real serial data stored in the buffer area to public network. The range is 10-65535 ms. Note: data will be sent out to public network when real serial data size reaches the preset packet size, even though it's within the serial frame interval.	100

Table 3-4-2-2 DTU Parameters

Item	Description	Default
Transparent		
Protocol	Select TCP or UDP protocol.	TCP
Keepalive Interval (s)	After TCP client is connected with TCP server, the client will send heartbeat packet by TCP regularly to keep alive. The interval range is 1-3600 s.	75
Keepalive Retry Times	When TCP heartbeat times out, the router will resend heartbeat. After it reaches the preset retry times, router will reconnect to TCP server. The range is 1-16.	9
Packet Size	Set the size of the serial data frame. Packet will be sent out when preset frame size is reached. The range is 1-1024 bytes.	1024
Serial Frame Interval	The interval that the router sends out real serial data stored in the buffer area to public network. The range is 10-65535 ms. Note: data will be sent out to public network when real serial data size reaches the preset packet size, even though it's within the serial frame interval.	100
Reconnect Interval	After connection failure, router will reconnect to the server at the preset interval. The range is 10-60 s.	10
Specific Protocol	By Specific Protocol, the router will be able to connect to the TCP2COM software.	--
Heartbeat Interval	By Specific Protocol, the router will send heartbeat packet to the server regularly to keep alive. The interval range is 1-3600 s.	30
ID	Define unique ID of each router. No longer than 63 characters without space character.	--
Register String	Define register string for connection with the server.	Null
Server Address	Fill in the TCP or UDP server address (IP/domain name).	Null
Server Port	Fill in the TCP or UDP server port. Range: 1-65535.	Null
Status	Show the connection status between the router and the server.	--
Modbus		
Local Port	Set the router listening port. Range: 1-65535.	502
Maximum TCP Clients	Specify the maximum number of TCP clients allowed to connect to the router which act as a TCP server.	32
Connection Timeout	If the TCP server does not receive any data from the slave device within the connection timeout period, the TCP connection will be broken.	60
Reading Interval	Set the interval for reading remote channels. When a read cycle ends, the new read cycle begins until this interval expires. If it is set to 0, the device will restart the new read cycle after all channels have been read.	100
Response Timeout	Set the maximum response time that the router waits for the response to the command. If the device does not get a response after the maximum response time, it's determined that the command has timed out.	3000
Maximum Retries	Set the maximum retry times after it fails to read.	3

MQTT		
Packet Size	Set the size of the serial data frame. Packet will be sent out when preset frame size is reached. The range is 1-1024 bytes.	1024
Serial Frame Interval	The interval that the router sends out real serial data stored in the buffer area to public network. The range is 10-65535 ms. Note: data will be sent out to public network when real serial data size reaches the preset packet size, even though it's within the serial frame interval.	100
MQTT Connection	Select the MQTT connection to send serial port data, it's set up on Service > MQTT page.	Null
Topic	Topic name used for publishing serial port data.	Null
Retain	Enable to set the latest message of this topic as retain message.	Null
QoS	QoS0, QoS1 or QoS2 are optional.	Null

Table 3-4-2-3 DTU Parameters

Related Configuration Example

[DTU Application Example](#)

3.4.3 Modbus Server (Slave)

This section describes how to achieve I/O status via Modbus TCP, Modbus RTU and Modbus RTU over TCP.

3.4.3.1 Modbus TCP

You can define the address of the DI and DO ports so as to poll DI's status and control DO's status via Modbus TCP protocol.

Figure 3-4-3-1

Modbus TCP		
Item	Description	Default
Enable	Enable/disable Modbus TCP.	Disable
Port	Set the router listening port. Range: 1-65535.	502
DI Address	Define the address of DI, range: 0-255.	0
DO Address	Define the address of DO, range: 0, 2-255.	0

Table 3-4-3-1 Modbus TCP Parameters

3.4.3.2 Modbus RTU

You can define the address of the DI and DO ports so as to poll DI's status and control DO's status via Modbus RTU protocol.

Figure 3-4-3-2

Modbus RTU		
Item	Description	Default
Enable	Enable/disable Modbus RTU.	Disable
Serial Port	Select the corresponding serial port.	serial
Server ID	Set server ID is used for distinguishing different devices on the same link.	1
DI Address	Define the address of DI, range: 0-255.	0
DO Address	Define the address of DO, range: 0, 2-255.	0

Table 3-4-3-2 Modbus RTU Parameters

3.4.3.3 Modbus RTU Over TCP

You can define the address of the DI and DO ports so as to poll DI's status and control DO's status via Modbus RTU over TCP.

Figure 3-4-3-3

Modbus RTU Over TCP		
Item	Description	Default
Enable	Enable/disable Modbus RTU over TCP function.	Disable

Server ID	Set server ID is used for distinguishing different devices on the same link.	1
Device ID	Set device ID. The server will get the device ID to the server for identifying identity so that the server can manage multiple devices.	--
Reconnection Interval	The reconnection interval when the device and the server fails to establish connection or disconnected.	10
DI Address	Define the address of DI, range: 0-255.	0
DO Address	Define the address of DO, range: 0, 2-255.	0
Server List		
IP	Enter the IP address of the server.	
Port	Enter the port of the server.Range: 0-65535.	
Status	Show the connection status between the router and the server.	

Table 3-4-3-3 Modbus RTU Over TCP Parameters

3.4.4 Modbus Client (Master)

UR32 router can be set as Modbus Client to poll the remote Modbus Server and send alarm according to the response.

3.4.4.1 Modbus Client

Modbus Client Setting

Enable

Read Interval s

Max. Retries

Max. Response Time ms

Execution Interval ms

Channel Name Read

Save & Apply

Figure 3-4-4-1

Modbus Client		
Item	Description	Default
Enable	Enable/disable Modbus client.	--
Read Interval/s	Set the interval for reading remote channels. When the read cycle ends, the commands which haven't been sent out will be discard, and the new read cycle begins. If it is set to 0, the device will restart the new read cycle after all channels have been read. Range: 0-600.	0
Max. Retries	Set the maximum retry times after it fails to read, range: 0-5.	3

Max. Response Time/ms	Set the maximum response time that the router waits for the response to the command. If the device does not get a response after the maximum response time, it's determined that the command has timed out. Range: 10-1000.	500
Execution Interval/ms	The execution interval between each command. Range: 10-1000.	50
Channel Name	Select a readable channel form the channel list.	--

Table 3-4-4-1

3.4.4.2 Channel

You can add the channels and configure alarm setting on this page, so as to connect the router to the remote Modbus Server to poll the address on this page and receive alarms from the router in different conditions.

Figure 3-4-4-2

Channel Setting	
Item	Description
Name	Set the name to identify the remote channel. It cannot be blank.
Server ID	Set Modbus server ID.
Address	The starting address for Modbus reading.
Number	The reading quantity from starting address.
Type	Read command data type, options are Coil, Discrete, Holding Register (INT16), Input Register (INT16), Holding Register (INT32) and Holding Register (Float).
Link	Select serial port or TCP connection. Serial Port: the router communicate with devices via Modbus RTU protocol. TCP: the router communicate with devices via Modbus TCP protocol.
IP address	When link is TCP, fill in the IP address of the remote Modbus TCP device.
Port	When link is TCP, fill in the port of the remote Modbus TCP device.
Sign	When type is holding register or input register, enable or disable to identify whether this channel is signed.
Decimal Place	When type is holding register or input register, indicate a dot in the read into the position of the channel. For example: read the channel value is 1234 and a Decimal Place is equal to 2, then the actual value is 12.34.

Table 3-4-4-2

Alarm Setting

Name	tunnel1
Condition	GE(>)
Max. Threshold	0
Alarm	<input checked="" type="checkbox"/> SMS <input checked="" type="checkbox"/> Email
Phone Group	
Email Group	
Normal Content	Note: \$YEAR/\$MON/\$DAY \$TIME, get NORMAL data \$VALUE from address \$ADDRESS of channel \$NAME. (Abnormal scope is
Abnormal Content	Note: \$YEAR/\$MON/\$DAY \$TIME, get ABERRANT data \$VALUE from address \$ADDRESS of channel \$NAME. (Abnormal scope is
Continuous Alarm	<input type="checkbox"/>

Save Cancel

Figure 3-4-4-3

Alarm Setting	
Item	Description
Name	Set the same name with the channel name to identify the remote channel.
Condition	The condition that triggers alert.
Min. Threshold	Set the min. value to trigger the alert. When the actual value is less than this value, the alarm will be triggered.
Max. Threshold	Set the max. value to trigger the alert. When the actual value is more than this value, the alarm will be triggered.
Alarm	Select the alarm method as SMS or Email.
SMS	The preset alarm content will be sent to the specified phone number.
Phone Group	Select the phone group to receive the alarm SMS.
Email Group	Select the Email group to receive the alarm Email.
Normal Content	When the actual value is restored to the normal value from exceeding the threshold value, the router will automatically cancel the abnormal alarm and send the preset normal content to the specified phone group.
Abnormal Content	When the actual value exceeds the preset threshold, the router will automatically trigger the alarm and send the preset abnormal content to the specified phone group.
Continuous Alarm	Once it is enabled, the same alarm will be continuously reported. Otherwise, the same alarm will be reported only one time.

Table 3-4-4-3

Figure 3-4-4-4

TCP Forwarding	
Item	Description
Name	The name of Modbus Client's channel.
IP	The IP address of the server which the packets are forwarded to.
Port	The port of the server's which the packets are forwarded to.

Table 3-4-4-4

Figure 3-4-4-5

MQTT Forward	
Item	Description
Name	The name of Modbus Master's channel.
MQTT Connections	Select the MQTT connection to send Modbus channel data, it's set up on Service > MQTT page.
Topic	Topic name used for publishing Modbus channel data.
Retain	Enable to set the latest message of this topic as retain message.
QoS	QoS0, QoS1 or QoS2 are optional.

Table 3-4-4-5

3.4.5 GPS (Only Applicable to GPS Version)

When you want to receive GPS data, you should enable GPS function on this page.

Figure 3-4-5-1

3.4.5.1 GPS IP Forwarding

GPS IP forwarding means that GPS data can be forwarded over the Internet.

Figure 3-4-5-2

Figure 3-4-5-3

GPS IP Forwarding		
Item	Description	Default
Enable	Forward the GPS data to the client or server.	Disable
Type	Select connection type of the router as Client or Server.	Client
Protocol	Select protocol of data transmission as TCP or UDP.	TCP
Keepalive Interval	After it's connected with server/client, the router will send heartbeat packet regularly to the server/client to keep alive. The interval range is 1-3600 s.	75
Keepalive Retry	When TCP heartbeat times out, the router will resend heartbeat. After it reaches the preset retry times, router will reconnect to TCP server. The range is 1-16.	9
Local Port	Set the router listening port. Range: 1-65535.	
Reconnect Interval	After connection failure, router will reconnect to the server at the preset interval. The range is 10-60 s.	10
Report Interval	Router will send GPS data to the server/client at the preset interval. The range is 1-60 s.	30
Include RMC	RMC includes time, date, position, course and speed data.	--
Include GSA	GSA includes GPS receiver operating mode, satellites used in the	--

	position solution, and DOP values.	
Include GGA	GGA includes time, position and fix type data.	--
Include GSV	GSV includes the number, elevation, azimuth of GPS satellites and SNR values.	--
Message Prefix	Add a prefix to the GPS data.	Null
Message Suffix	Add a suffix to the GPS data.	Null
Destination IP Address		
Server Address	Fill in the server address to receive GPS data (IP/domain name).	--
Server Port	Fill in the port to receive GPS data. Range: 1-65535.	--
Status	Show the connection status between the router and the server.	--

Table 3-4-5-1 GPS IP Forwarding Parameters

3.4.5.2 GPS Serial Forwarding

GPS IP forwarding means that GPS data can be forwarded to the serial port.

GPS Serial Forwarding

Enable

Serial Type

Trap Interval

Include RMC

Include GSA

Include GGA

Include GSV

Figure 3-4-5-4

GPS Serial Forwarding		
Item	Description	Default
Enable	Forward the GPS data to the preset serial port.	Disable
Serial Type	Select the serial port to receive GPS data. Ensure that the serial port is enabled on Service > Serial Port .	--
Report Interval	Router will forward the GPS data to the serial port at the preset interval. The range is 1-60 s.	30
Include RMC	RMC includes time, date, position, course and speed data.	--
Include GSA	GSA includes GPS receiver operating mode, satellites used in the position solution, and DOP values.	--
Include GGA	GGA includes time, position and fix type data.	--

Include GSV	GSV includes the number, elevation, azimuth of GPS satellites and SNR values.	--
-------------	---	----

Table 3-4-5-2 GPS Serial Forwarding Parameters

3.4.5.3 GPS MQTT Forward

GPS MQTT forward means that GPS raw data can be forwarded to MQTT broker automatically.

Figure 3-4-5-5

GPS MQTT Forward		
Item	Description	Default
Enable	Forward the GPS data to MTT broker automatically.	Disable
Trap Interval	The interval to locate and forward the GPS data to the MQTT broker. The range is 1-60 s.	30
Include RMC	RMC includes time, date, position, course and speed data.	--
Include GSA	GSA includes GPS receiver operating mode, satellites used in the position solution, and DOP values.	--
Include GGA	GGA includes time, position and fix type data.	--
Include GSV	GSV includes the number, elevation, azimuth of GPS satellites and SNR values.	--
MQTT Forward		
MQTT Connections	Select the MQTT connection to send GPS data, it's set up on Service > MQTT page.	
Topic	Topic name for publishing GPS raw data.	
Retain	Enable to set the latest message of this topic as retain message.	
QoS	QoS0, QoS1 or QoS2 are optional.	

Table 3-4-5-3 GPS MQTT Forward Parameters

3.4.6 MQTT

UR32 supports to work as MQTT client to forward data and router information to MQTT broker in two ways:

1. Users send requests to the router to enquire the router information;
2. The router publishes the data automatically.

MQTT

Connections



ID	Name	Address	Status	Operation
1	mqtttest1	192.168.44.54:1883	Connected	 
2	555	666:1883	Disconnected	 
				

Figure 3-4-6-1

MQTT

Status

Status Disable

General

Name

Enable

Broker Address

Broker Port

Client ID

Connection Timeout(s)

Keep Alive Interval(s)

Auto Reconnect

Reconnect Period

Clean Session

User Credentials

Enable

Username

Password

TLS

Enable

Mode

Figure 3-4-6-2

Last Will and Testament

Enable

Last-Will Topic

Last-Will QoS

Last-Will Retain

Last-Will Payload

Request and Response Topic

Data Type	Topic	Retain	QoS
Status Request	<input type="text"/>	<input type="checkbox"/>	<input type="text" value="QoS 0"/>
Status Response	<input type="text"/>	<input type="checkbox"/>	<input type="text" value="QoS 0"/>

System Status Publish Topic

Data Type	Topic	Publish Interval(s)	Retain	QoS
System Info	<input type="text"/>	<input type="text"/>	<input type="checkbox"/>	<input type="text" value="QoS 0"/>
System Status	<input type="text"/>	<input type="text"/>	<input type="checkbox"/>	<input type="text" value="QoS 0"/>
Cellular	<input type="text"/>	<input type="text"/>	<input type="checkbox"/>	<input type="text" value="QoS 0"/>
Ethernet	<input type="text"/>	<input type="text"/>	<input type="checkbox"/>	<input type="text" value="QoS 0"/>
GPS	<input type="text"/>	<input type="text"/>	<input type="checkbox"/>	<input type="text" value="QoS 0"/>

Figure 3-4-6-3

MQTT Settings	
Item	Description
Status	Show connection status between router and MQTT broker.
General	
Name	Customize a unique connection name. It is not allowed to change after save.
Enable	Enable or disable this MQTT connection.
Broker Address	MQTT broker address to receive data.
Broker Port	MQTT broker port to receive data.
Client ID	Client ID is the unique identity of the client to the server. It must be unique when all clients are connected to the same server, and it is the key to handle messages at QoS 1 and 2.
Connection Timeout/s	If the client does not get a response after the connection timeout, the connection will be considered as broken. The Range: 1-65535.
Keep Alive Interval/s	After the client is connected to the server, the client will send heartbeat packet to the server regularly to keep alive. Range: 1-65535.
Auto	When connection is broken, try to reconnect the server automatically.

Reconnect	
Reconnect Period	When connection is broken, the period to reconnect the server periodically.
Clean Session	When enabled, the connection will create a temporary session and all information will lose when the client is disconnected from broker; when disabled, the connection will create a persistent session that will remain and save offline messages until the session logs out overtime.
User Credentials	
Enable	Enable user credentials.
Username	The username used for connecting to the MQTT broker.
Password	The password used for connecting to the MQTT broker.
TLS	
Enable	Enable the TLS encryption in MQTT communication.
Mode	Select from Self signed certificates, CA signed server certificate. CA signed server certificate: verify with the certificate issued by Certificate Authority (CA) that pre-loaded on the device. Self signed certificates: upload the custom CA certificates, client certificates and secret key for verification.
Last Will and Testament	
Enable	Last will message is automatically sent when the MQTT client is abnormally disconnected. It is usually used to send device status information or inform other devices or proxy servers of the device's offline status.
Last-Will Topic	Customize the topic to receive last will messages.
Last-Will QoS	QoS0, QoS1 or QoS2 are optional.
Last-Will Retain	Enable to set last will message as retain message.
Last-Will Payload	Customize the last will message contents.
Request and Response Topic	
Topic	The router supports to send requests to enquire router information. Status Request: users is able to send requests to this topic to enquire router information. Request format: <pre>{ "id": "1", "status": "systeminfo" }</pre> The id is a random value, and the status can be set as 5 types: systeminfo, systemstatus, cellular, ethernet, gps. Status Response: users is able to subscribe this topic to get the replies.
Retain	Enable to set the latest message of this topic as retain message.
QoS	QoS0, QoS1 or QoS2 are optional.
System Status Publish Topic	
Data Type	Data type sent to MQTT broker automatically. Note that the GPS in this page is not raw data but decoded location data.

Topic	Topic name of the data type used for publishing.
Publish Interval (s)	The interval to publish data to MQTT broker automatically.
Retain	Enable to set the latest message of this topic as retain message.
QoS	QoS0, QoS1 or QoS2 are optional.

Table 3-4-6-1 MQTT Parameters

3.4.7 SNMP

SNMP is widely used in network management for network monitoring. SNMP exposes management data with variables form in managed system. The system is organized in a management information base (MIB) which describes the system status and configuration. These variables can be remotely queried by managing applications.

Configuring SNMP in networking, NMS, and a management program of SNMP should be set up at the Manager.

Configuration steps are listed as below for achieving query from NMS:

1. Enable SNMP setting.
2. Download MIB file and load it into NMS.
3. Configure MIB View.
4. Configure VACM.

Related Configuration Example

[SNMP Application Example](#)

3.4.7.1 SNMP

UR32 supports SNMPv1, SNMPv2c and SNMPv3 version. SNMPv1 and SNMPv2c employ community name authentication. SNMPv3 employs authentication encryption by username and password.

The screenshot shows a configuration page with tabs for SNMP, MIB View, VACM, Trap, and MIB. The 'SNMP' tab is active. Under 'SNMP Settings', there are five rows of configuration options:

- Enable:** A checkbox that is checked.
- Port:** A text input field containing the value '161'.
- SNMP Version:** A dropdown menu currently set to 'SNMPv2'.
- Location Information:** A text input field containing the value '225_location'.
- Contact Information:** A text input field containing the value '225_Contact'.

A blue 'Save' button is located at the bottom left of the configuration area.

Figure 3-4-7-1

SNMP Settings	
Item	Description
Enable	Enable or disable SNMP function.
Port	Set SNMP listened port. Range: 1-65535. The default port is 161.
SNMP Version	Select SNMP version; support SNMP v1/v2c/v3.
Location Information	Fill in the location information.
Contact Information	Fill in the contact information.

Table 3-4-7-1 SNMP Parameters

3.4.7.2 MIB View

This section explains how to configure MIB view for the objects.

SNMP	MIB View	VACM	Trap	MIB
View List				
View Name	View Filter	View OID	Operation	
All	Included	1	✕	
system	Included	1.3.6.1.2.1.1	✕	
				+

Figure 3-4-7-2

MIB View	
Item	Description
View Name	Set MIB view's name.
View Filter	Select from "Included" and "Excluded".
View OID	Enter the OID number.
Included	You can query all nodes within the specified MIB node.
Excluded	You can query all nodes except for the specified MIB node.

Table 3-4-7-2 MIB View Parameters

3.4.7.3 VACM

This section describes how to configure VACM parameters.

SNMP	MIB View	VACM	Trap	MIB
SNMP v1 & v2 User List				
Community	Permission	MIB View	Network	Operation
private	Read-Write	All	0.0.0.0/0	✕
public	Read-Write	All	0.0.0.0/0	✕
				+

Figure 3-4-7-3

VACM	
Item	Description
SNMP v1 & v2 User List	
Community	Set the community name.
Permission	Select from "Read-Only" and "Read-Write".
MIB View	Select an MIB view to set permissions from the MIB view list.
Network	The IP address and bits of the external network accessing the MIB view.
Read-Write	The permission of the specified MIB node is read and write.
Read-Only	The permission of the specified MIB node is read only.
SNMP v3 User Group	
Group Name	Set the name of SNMPv3 group.
Security Level	Select from "NoAuth/NoPriv", "Auth/NoPriv", and "Auth/Priv".
Read-Only View	Select an MIB view to set permission as "Read-only" from the MIB view list.
Read-Write View	Select an MIB view to set permission as "Read-write" from the MIB view list.
Inform View	Select an MIB view to set permission as "Inform" from the MIB view list.
SNMP v3 User List	
Username	Set the name of SNMPv3 user.
Group Name	Select a user group to be configured from the user group.
Authentication	Select from "MD5", "SHA", and "None".
Authentication Password	The password should be filled in if authentication is "MD5" and "SHA".
Encryption	Select from "AES", "DES", and "None".
Encryption Password	The password should be filled in if encryption is "AES" and "DES".

Table 3-4-7-3 VACM Parameters

3.4.7.4 Trap

This section explains how to enable network monitoring by SNMP trap.

Figure 3-4-7-4

SNMP Trap	
Item	Description
Enable	Enable or disable SNMP Trap function.
SNMP Version	Select SNMP version; support SNMP v1/v2c/v3.
Server Address	Fill in NMS's IP address or domain name.
Port	Fill in UDP port. Port range is 1-65535. The default port is 162.
Name	Fill in the group name when using SNMP v1/v2c; fill in the username when using SNMP v3.
Auth/Priv Mode	Select from "NoAuth & No Priv", "Auth & NoPriv", and "Auth & Priv".

Table 3-4-7-4 Trap Parameters

3.4.7.5 MIB

This section describes how to download MIB files. The last MIB file "LTE-ROUTER-MIB.txt" is for the UR32 router.

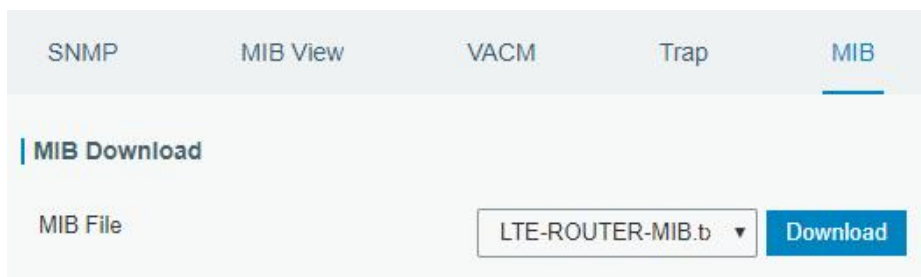

Figure 3-4-7-5

MIB	
Item	Description
MIB File	Select the MIB file you need.
Download	Click "Download" button to download the MIB file to PC.

Table 3-4-7-5 MIB Download

3.4.8 TR069

Technical Report 069 (TR-069) is a technical specification of Broadband Forum that defines an application layer protocol for remote management and provisioning of customer-premises equipment (CPE) connected to an Internet Protocol (IP) network.

TR-069

TR-069

Enable

Status

Last Inform -

ACS Setting

URL

ACS Username

ACS Password

CPE Setting

Enable Period Inform

Period Inform Interval(s)

CPE Username

CPE Password

Figure 3-4-8-1

TR-069	
Item	Description
Enable	Enable or disable TR069 feature.
Last Inform	The last time the router informed to TR069 ACS.
ACS Setting	
URL	The URL of TR069 auto configuration server (ACS).
ACS Username	The username used by ACS to authenticate the CPE when it initiates a connection request.
ACS Password	The password used by ACS to authenticate the CPE when it initiates a connection request.
CPE Setting	
Enable Period Inform	Enable or disable inform periodically.
Period Inform Interval (s)	The interval to report information to ACS, this should be less than the timeout of peer ACS.
CPE Username	The username used by CPE to authenticate the ACS when it initiates a connection request.
CPE Password	The password used by CPE to authenticate the ACS when it initiates a connection request.

Table 3-4-8-1 TR069 Parameters

3.5 Maintenance

This section describes system maintenance tools and management.

3.5.1 Tools

Troubleshooting tools includes ping, traceroute, packet analyzer and qxdmlog.

3.5.1.1 Ping

Ping tool is engineered to ping outer network.



Figure 3-5-1-1

PING	
Item	Description
Host	Ping outer network from the router.

Table 3-5-1-1 IP Ping Parameters

3.5.1.2 Traceroute

Traceroute tool is used for troubleshooting network routing failures.



Figure 3-5-1-2

Traceroute	
Item	Description
Host	Address of the destination host to be detected.

Table 3-5-1-2 Traceroute Parameters

3.5.1.3 Packet Analyzer

Packet Analyzer is used for capturing the packet of different interfaces.

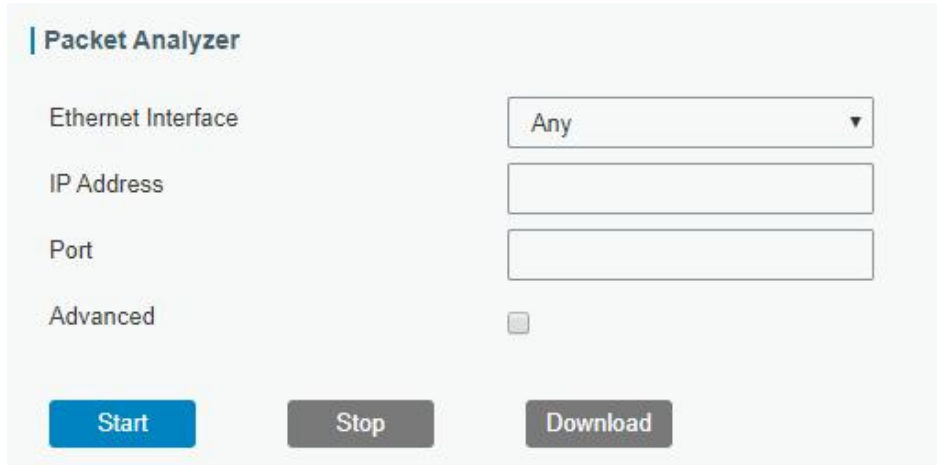

Figure 3-5-1-3

Packet Analyzer	
Item	Description
Ethernet Interface	Select the interface to capture packages.
IP Address	Set the IP address that the router will capture.
Port	Set the port that the router will capture.
Advanced	Set the rules for sniffer. The format is tcpdump.

Table 3-5-1-3 Packet Analyzer Parameters

3.5.1.4 Qxdmlog

This section allow collecting diagnostic logs via QXDM tool.



Figure 3-5-1-4

3.5.2 Debugger

3.5.2.1 Cellular Debugger

This section explains how to send AT commands to router and check cellular debug information.

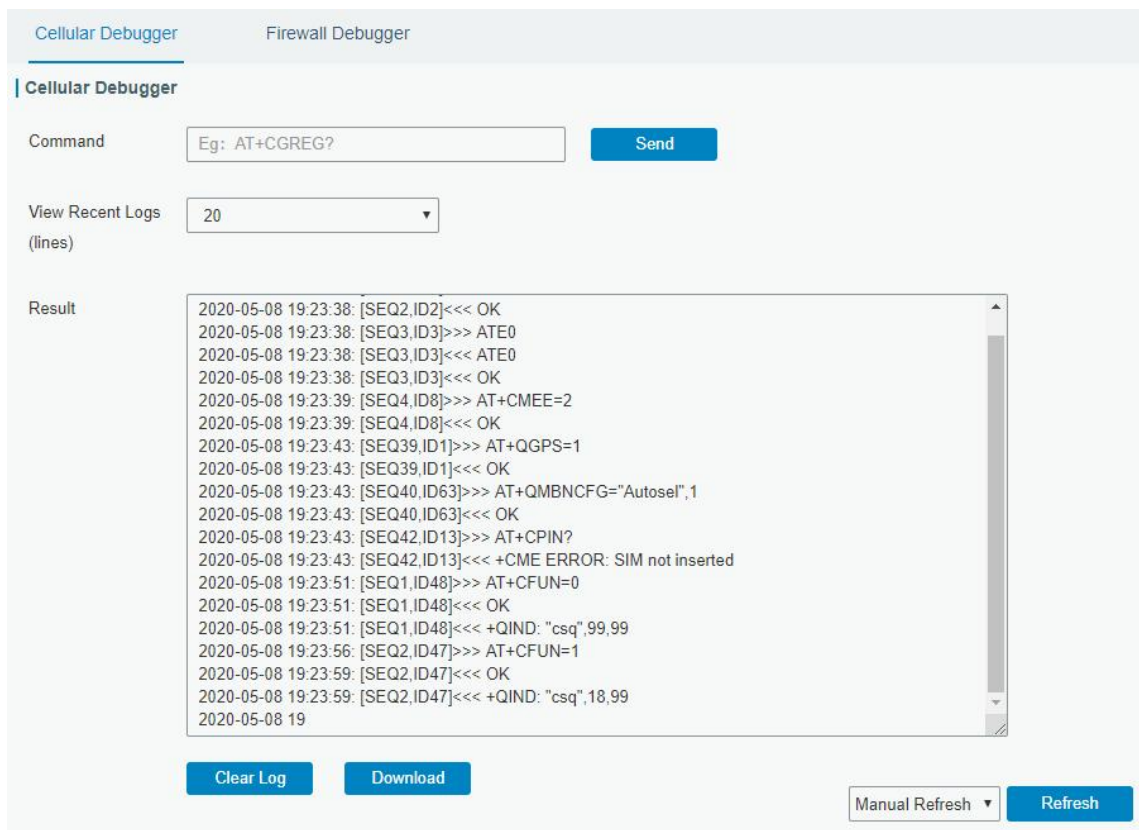

Figure 3-5-2-1

Cellular Debugger	
Item	Description
Command	Enter the AT command that you want to send to cellular modem.
View Recent Logs (lines)	View the specified lines of the result.
Result	Show the response result from cellular modem.

Table 3-5-2-1 Cellular Debugger Parameters

3.5.2.2 Firewall Debugger

This section explains how to send commands to router and check firewall information.

Figure 3-5-2-2

Firewall Debugger	
Item	Description
Command	Enter the AT command that you want to send to firewall module.
Result	Show the response result from firewall module.

Table 3-5-2-2 Firewall Debugger Parameters

3.5.3 Log

The system log contains a record of informational, error and warning events that indicates how the system processes. By reviewing the data contained in the log, an administrator or user troubleshooting the system can identify the cause of a problem or whether the system processes are loading successfully. Remote log server is feasible, and router will upload all system logs to remote log server such as Syslog Watcher.

3.5.3.1 System Log

This section describes how to view the recent log on web.

Figure 3-5-3-1

System Log	
Item	Description
View recent (lines)	View the specified lines of system log.
Clear Log	Clear the current system log.

Table 3-5-3-1 System Log Parameter

3.5.3.2 Log Download

This section describes how to download log files.

File Name	File Size/KB	Creation Time	Operation
vpn.log	1	2020/04/30 14:37:55	↓
system.log	872	2020/05/08 19:35:03	↓
httpd.log	645	2020/05/08 19:34:12	↓
firewall.log	0	2020/04/30 14:37:09	↓
cellular.log	1619	2020/05/08 19:35:01	↓

Figure 3-5-3-2

Log Download	
Item	Description
Download All	Download all log files.

File Name	Show the name of log files.
File Size/KB	Show the size of log files.
Creation Time	Show the creation time of log files.
Operation	Click to download every log file.

Table 3-5-3-2 System Log Parameter

3.5.3.3 Log Settings

This section explains how to enable remote log server and local log setting.

Figure 3-5-3-3

Log Settings	
Item	Description
Remote Log Server	
Enable	With “Remote Log Server” enabled, router will send all system logs to the remote server.
Syslog Server Address	Fill in the remote system log server address (IP/domain name).
Port	Fill in the remote system log server port.
Local Log File	
Storage	User can store the log file in memory or TF card.
Size	Set the size of the log file to be stored.
Log Severity	The list of severities follows the syslog protocol.

Table 3-5-3-3 Log Settings Parameters

3.5.4 Upgrade

This section describes how to upgrade the router firmware via web. Generally you don't need to do the firmware upgrade.

Note: any operation on web page is not allowed during firmware upgrade, otherwise the upgrade will be interrupted, or even the device will break down.

Figure 3-5-4-1

Upgrade	
Item	Description
Firmware Version	Show the current firmware version.
Reset Configuration to Factory Default	When this option is checked, the router will be reset to factory defaults after upgrade.
Upgrade Firmware	Click "Browse" button to select the new firmware file, and click "Upgrade" to upgrade firmware.

Table 3-5-4-1 Upgrade Parameters

Related Configuration Example

[Firmware Upgrade](#)

3.5.5 Backup and Restore

This section explains how to create a complete backup of the system configurations to a file, restore the config file to the router and reset to factory defaults.

Figure 3-5-5-1

Backup and Restore	
Item	Description
Config File	Click "Browse" button to select configuration file, and then click "Import" button to upload the configuration file to the router.
Backup	Click "Backup" to export the current configuration file to the PC.
Reset	Click "Reset" button to reset factory default settings. Router will restart after reset process is done.

Table 3-5-5-1 Backup and Restore Parameters

Related Configuration Example

[Restore Factory Defaults](#)

3.5.6 Reboot

On this page you can reboot the router immediately or regularly. We strongly recommend clicking "Save" and "Apply" button before rebooting the router so as to avoid losing the new configuration.

Figure 3-5-6-1

Reboot	
Item	Description
Reboot Now	Reboot the router immediately.
Schedule	
Enable	Reboot the router at a scheduled frequency.
Cycles	Select the date and time to execute the schedule.

Table 3-5-2-1 Schedule Parameters

3.6 APP

3.6.1 Python

Python is an object-oriented programming language that has gained popularity because of its clear syntax and readability.

As an interpreted language, Python has a design philosophy that emphasizes code readability, notably using whitespace indentation to delimit code blocks rather than curly brackets or keywords, and a syntax that allows programmers to express concepts in fewer lines of code than it's used in other languages such as C++ or Java. The language provides constructs and intends to enable writing clear programs on both small and large scale.

Users can use Python to quickly generate the prototype of the program, which can be the final interface of the program, rewrite it with a more appropriate language, and then encapsulate the extended class library that Python can call.

This section describes how to view the relevant running status such as App-manager, SDK version, extended storage, etc. Also you can change the App-manager configuration, and import the Python App package from here.

3.6.1.1 Python

Micro SD card must be installed for Python App.

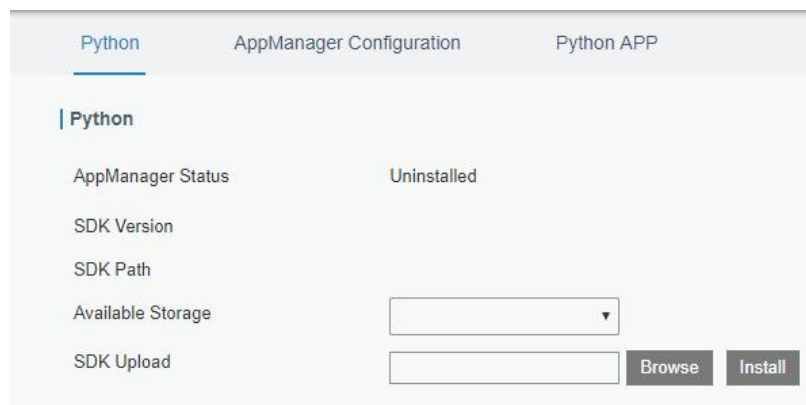

Figure 3-6-1-1

Python	
Item	Description
AppManager Status	Show AppManager's running status, like "Uninstalled", "Running" or "Stopped".
SDK Version	Show the version of the installed SDK.
SDK Path	Show the SDK installation path.
Available Storage	Select available storage such as Micro SD to install SDK.
SDK Upload	Upload and install SDK for Python.
Uninstall	Uninstall SDK.
View	View application status managed by AppManager.

Table 3-6-1-1 Python Parameters

3.6.1.2 App Manager Configuration

The screenshot shows the 'Python APP' configuration page. It has three tabs: 'Python', 'AppManager Configuration' (selected), and 'Python APP'. Under 'AppManager Configuration', there is an 'AppManager' section with an 'Enable' checkbox. Below that is an 'App Management' section containing a table with columns: ID, App Command, Logfile Size(MB), and Uninstall. At the bottom is an 'App Status' section with a table containing columns: App Name, App Version, and SDK Version.

Figure 3-6-1-2

AppManager Configuration	
Item	Description
Enable	After enabling Python AppManager, user can click "View" button on the "Python" webpage to view the application status managed by AppManager.
App Management	
ID	Show the ID of the imported App.
App Command	Show the name of the imported App.
Logfile Size(MB)	User-defined Logfile size. Range: 1-50.
Uninstall	Uninstall APP.
App Status	
App Name	Show the name of the imported App.
App Version	Show the version of the imported App.
SDK Version	Show the SDK version which the imported App is based on.

Table 3-6-1-2 APP Manager Parameters

3.6.1.3 Python App

The screenshot shows the 'Python APP' configuration page with the 'Python APP' tab selected. It features three main sections: 'Import App Package' with an 'App Package' input field and 'Browse'/'Import' buttons; 'Import App Configuration' with an 'App Name' dropdown, an 'App Configuration' input field, and 'Browse'/'Import' buttons; and 'Debug Script' with a 'Debug File' dropdown, an 'Export' button, and a 'Debug Script' input field with 'Browse'/'Import' buttons.

Figure 3-6-1-3

Item	Description
App Package	Select App package and import.
App Name	Select App to import configuration.
App Configuration	Select configuration file and import.
Debug File	Export script file.
Debug Script	Select Python script to be debugged and import.

Table 3-6-1-3 APP Parameters

Chapter 4 Application Examples

4.1 Network Connection

4.1.1 Cellular Connection

The UR32 routers have two cellular interfaces, named SIM1 & SIM2. Only one cellular interface is active at one time. We are about to take an example of inserting a SIM card into SIM1 slot of the UR32 and configuring the router to get Internet access through cellular.

Configuration Steps

1. Ensure the SIM card is inserted well before powering on and all cellular antennas are connected to the correct connectors.
2. Go to **Network > Interface > Cellular > Cellular Setting** to configure the cellular info, then click **Save** and **Apply**.

The screenshot shows the 'Cellular Settings' page. The left sidebar has 'Interface' selected. The main content area is titled 'Cellular Settings' and has tabs for 'Link Failover', 'Cellular', 'Port', 'WAN', 'Bridge', 'WLAN', 'Switch', and 'Loopback'. The 'Cellular' tab is active. It displays settings for two SIM cards: SIM1 and SIM2. Both are configured with IPv4. Other fields include APN, Username, Password, PIN Code (masked with ****), Access Number, Authentication Type (None), Network Type, and PPP Preferred (unchecked).

3. Go to **Network > Interface > Link Failover** to enable correspond SIM and drag buttons to change link priority.

The screenshot shows the 'Link Priority' page. The left sidebar has 'Interface' selected. The main content area is titled 'Link Priority' and has tabs for 'Link Failover', 'Cellular', 'Port', 'WAN', 'Bridge', 'Switch', and 'Loopback'. The 'Link Failover' tab is active. It displays a table with the following data:

Priority	Enable Rule	Link in use	Interface	Connection Type	IP	Operation
1	<input checked="" type="checkbox"/>	●	Cellular-SIM1	-	-	
2	<input checked="" type="checkbox"/>	●	Cellular-SIM2	DHCP	-	
3	<input checked="" type="checkbox"/>	●	WAN	Static IP	192.168.22.225	

4. Click to configure ICMP ping detection information. When ping probe is enabled, the router will send ICMP packets to detection server to check if this link is valid. If no response and exceeding max retries, it will switch to the lower priority link.

Note: if you use private SIM card, please change a private server address or disable the ping probe.

Ping Detection

Enable

IPv4 Primary Server

IPv4 Secondary Server

IPv6 Primary Server

IPv6 Secondary Server

Interval s

Retry Interval s

Timeout s

Max Ping Retries

- Go to **Status > Cellular** to view the status of the cellular connection. If it shows Connected, SIM1 has dialed up successfully.

Overview	Cellular	Network	WLAN	VPN	Routing	Host List	GPS
Modem		Network					
Model	EC20F	Status	Connected				
Version	EC20CEHCLGR06A05M1G	IPv4 Address	10.171.227.152/28				
Current SIM	SIM1	IPv4 Gateway	10.171.227.153				
Signal Level	31asu (-51dBm)	IPv4 DNS	211.143.147.120				
Register Status	Registered (Home network)	IPv6 Address	2409:8934:1a1e:ca08:9c3f:1718:6fcd:4ad3/64				
IMEI	861942056289607	IPv6 Gateway	2409:8934:1a1e:ca08:0e7:5c15:e8dd:111				
IMSI	460005970144200	IPv6 DNS	2409:8034:2000:0:0:0:0:4				
ICCID	898600511318F2001679	Connection Duration	0 days, 02:32:02				
ISP	CHINA MOBILE	Data Usage Monthly					
Network Type	TDD LTE	SIM-1	RX: 0.0 MIB TX: 0.0 MIB ALL: 0.0 MIB				
PLMN ID	46000	SIM-2	RX: 0.0 MIB TX: 0.0 MIB ALL: 0.0 MIB				
LAC	592f						
Cell ID	3d98485						

Related Topic

[Cellular Setting](#)

[Cellular Status](#)

4.1.2 Ethernet WAN Connection

UR32 supports to get Internet access via WAN port.

Configuration Steps

- Go to **Network > Interface > WAN** to select connection type and configure WAN parameters, then save all settings. The following examples of static IP type, DHCP Client type, and PPPoE type are

listed for your reference.

The screenshot shows the WAN configuration page for WAN_1. The configuration is as follows:

Field	Value
Enable	<input checked="" type="checkbox"/>
Port	LAN1/WAN
Connection Type	Static IP
IPv4 Address	192.168.22.225
Netmask	255.255.255.0
IPv4 Gateway	192.168.22.1
IPv6 Address	fe80::26e1:24ff:fe0:3192
Prefix-length	64
IPv6 Gateway	
MTU	1500
Primary DNS	8.8.8.8
Secondary DNS	
Enable NAT	<input checked="" type="checkbox"/>

2. Go to **Network > Interface > Link Failover** to enable WAN and drag buttons to change link priority.

The screenshot shows the Link Priority configuration page. The table below lists the configured links:

Priority	Enable Rule	Link in use	Interface	Connection Type	IP	Operation
1	<input checked="" type="checkbox"/>	●	WAN	Static IP	192.168.22.225	
2	<input checked="" type="checkbox"/>	●	Cellular-SIM1	DHCP	-	
3	<input checked="" type="checkbox"/>	●	Cellular-SIM2	-	-	

Related Topic

[WAN Setting](#)

[WAN Status](#)

4.2 Wi-Fi Application Example (Only Applicable to Wi-Fi Version)

4.2.1 AP Mode

UR32 supports to work as access point (AP) to provide network access to other devices.

Configuration Steps

1. Go to **Network > Interface > WLAN** to select work mode as AP and define the wireless parameters as required, then save all settings.

Link Failover	Cellular	Port	WAN	Bridge	WLAN
WLAN					
Enable	<input checked="" type="checkbox"/>				
Work Mode	AP				
BSSID	24:e1:24:f0:2f:eb				
Radio Type	802.11n(2.4GHz)				
Channel	Auto				
Bandwidth	20MHz				
SSID	Router_F02FEB				
Encryption Mode	WPA-PSK/WPA2-PSK				
Cipher	Auto				
Key	*****				
SSID Broadcast	<input checked="" type="checkbox"/>				
AP Isolation	<input type="checkbox"/>				
Guest Mode	<input type="checkbox"/>				
Max Client Number	10				

2. Use a smart phone to connect the access point of UR32. Go to **Status > WLAN**, and you can check the AP settings and information of the connected client/user.

WLAN Status						
Name	Status	Type	SSID	IP Address	Netmask	
WLAN	Running	AP	Router_F02FEB	192.168.1.1	255.255.255.0	

Associated Stations			
SSID	MAC Address	IP Address	Connection Duration
Router_F02FEB	3c:cd:5d:47:10:8e	192.168.1.191	18 seconds

4.2.2 Client Mode

UR32 supports to work as Wi-Fi client to connect to an access point to get Internet access.

Configuration Steps

1. Go to **Network > Interface > WLAN**, click **Scan** to search for access points and click **Join Network**,

then save the settings. For some access points, it is necessary to fill in the Wi-Fi password.

Link Failover	Cellular	Port	WAN	Bridge	WLAN
WLAN					
Enable	<input checked="" type="checkbox"/>				
Work Mode	Client			<input type="button" value="Scan"/>	
SSID	WIFI TEST				
BSSID	3c:cd:5d:47:10:8e				
Encryption Mode	WPA2-PSK				
Cipher	AES				
Key	*****				
IP Setting					
Protocol	DHCP Client				

2. Go to **Status > WLAN**, and you can check the connection status of the client.

Overview	Cellular	Network	WLAN	VPN	Routing	Host List	GPS
WLAN Status							
Name	Status	Type	SSID	IP Address	Netmask		
WLAN	Connected	Client	WIFI TEST				
Associated Stations							
SSID	MAC Address	IP Address	Connection Duration				
WIFI TEST	3c:cd:5d:47:10:8e		1353 seconds				

Related Topic

[WLAN Setting](#)

[WLAN Status](#)

4.3 OpenVPN Client Application Example

UR32 routers can work as OpenVPN clients or OpenVPN servers. We are about to take an example of configuring OpenVPN client to connect to OpenVPN cloud.

Configuration Steps

1. Ensure the UR32 has gotten access to the Internet.
2. Log in the openVPN cloud account, select Network section and select the service depending on your requirement and follow the wizard to continue the settings.

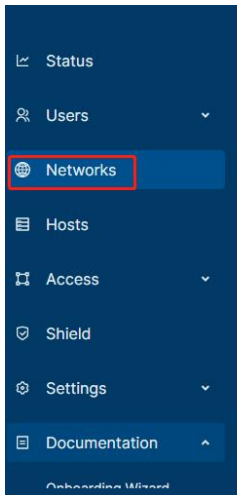

Select Network Scenarios

Please select all applicable scenarios for the network, which you are going to create.

- Remote Access** ⓘ
Connect your private resources to OpenVPN Cloud. Provide remote access to your resources, which are hosted on IaaS Cloud, and on premises resources. [Read more](#) ⓘ.
- Site-to-site** ⓘ
Connect multiple private networks to OpenVPN Cloud (site-to site connectivity). This wizard will assist you in adding a single network. Repeatedly use this wizard to connect all your networks. [Read more](#) ⓘ.
- Secure Internet Access** ⓘ
Provide secure access to public resources. Use this network as an Internet Gateway for all Internet traffic or only for selected public resources. You can then apply whitelisting rules on your public resources. [Read more](#) ⓘ.

 If you would like to connect a single server, you can create a [host](#) ⓘ and connect your server directly to OpenVPN Cloud

3. Select the location as OpenWrt and download the OVPN file.

Each Connector must be installed and connected to CloudConnexa. Select where you would like to deploy Network Connector.

OpenVPN Compatible Router: OpenWrt ▼

1 Download .ovpn Profile

[Download OVPN Profile](#)

2 Use .ovpn Profile

Use .ovpn Profile on your router and connect it to CloudConnexa

[Read how to use .ovpn Profile and connect OpenWrt router to CloudConnexa](#) ↗

After you deployed a connector, click Next to check that connector is online.

Back

Next

4. Go to **Network > VPN > OpenVPN Client**, select configuration method as File Configuration, then import the OVPN file.

OpenVPN Client Settings

OpenVPN Client_1

Enable

Configuration Method

Configuration File

5. Go to **Status > VPN** page to check if the client is connected.

Overview Cellular Network WLAN **VPN** Routing Host List GPS

Clients

Name	Status	Local IP	Remote IP
openvpn_1	Connected	100.96.1.18	100.96.1.17
ipsec_1	Disconnected	-	-

You can also check the connection status on OpenVPN cloud.

Connectors +

Connector is an unattended device, which provides constant connectivity to OpenVPN Cloud.

Connection Status	Name	Region	Tunnel IP Address	
<input checked="" type="checkbox"/> Online	connector01	London	100.96.1.18 fd:0:0:8101::2	Deploy <input type="button" value="▼"/> <input type="button" value="✎"/> <input type="button" value="⋮"/>

6. You can remotely get access to this router via OpenVPN Connect software. If you need to access the terminal devices under subnet, it's necessary to assign the subnet on OpenVPN cloud.

Subnets +

Private and Public subnets, which will be routed to this Network.

IP Address or Subnet	Description	
<input type="checkbox"/> 192.168.2.0/24		Add Service <input type="button" value="✎"/> <input type="button" value="⋮"/>

Related Topic

[OpenVPN Client](#)

[VPN Status](#)

4.4 NAT Application Example

Example

An UR32 router can access to the Internet via cellular and get a public IP address. LAN port is connected with an IP camera whose IP address is 192.168.23.165 and HTTP port is 80. This IP camera can be accessed by public IP address via the below port mapping settings.

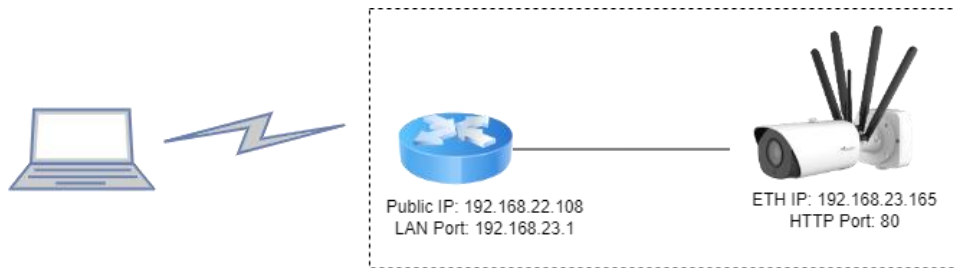

Configuration Steps

Go to **Firewall > Port Mapping** and configure port mapping parameters as below. Source IP address 0.0.0.0/0 means all external addresses are allowed to access. After that, users can use public IP: external port to access the IP camera.

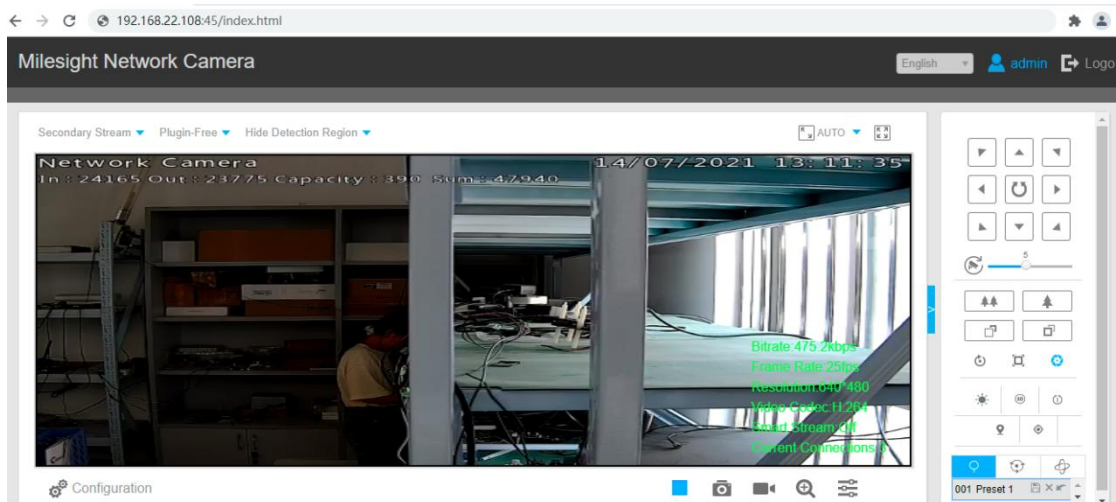
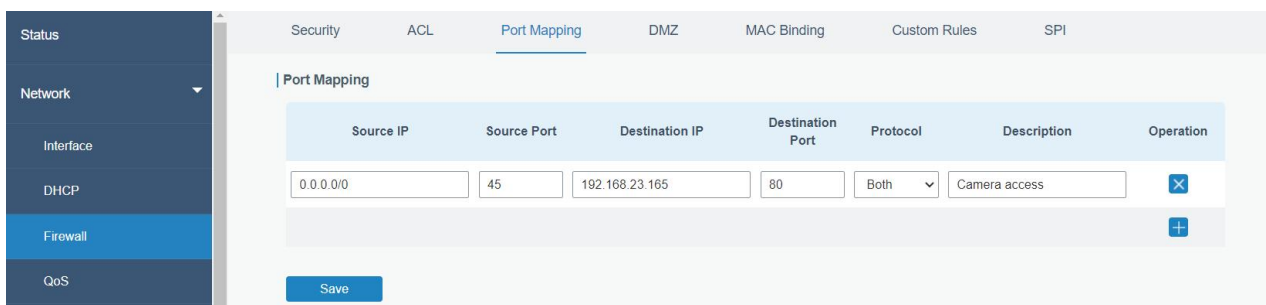

Related Topic

[Port Mapping](#)

4.5 DTU Application Example

Example

A PLC is connected with the UR32 via RS232 and need to forward the data to a remote TCP server transparently.

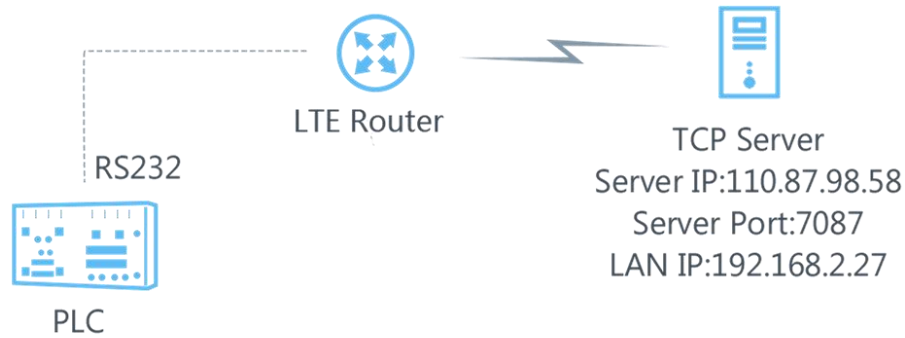

Configuration Steps

1. Go to **Service > Serial Port > Serial1**, enable Serial 1 and configure serial port parameters. The serial port parameter shall be kept in consistency with those of PLC, as shown in figure below.

Serial

Serial Settings

Enable

Serial Type RS232

Baud Rate 9600

Data Bits 8bits

Stop Bits 1bits

Parity None

Software Flow Control

2. Configure Serial Mode as DTU Mode, DTU protocol as Transparent and protocol as TCP.

Serial Mode DTU Mode

DTU Protocol Transparent

Protocol TCP

Keepalive Interval 75 s

Keepalive Retry Times 9

Packet Size 1024 Bytes

Serial Frame Interval 100 ms

Reconnect Interval 10 s

Specific Protocol

Register String

3. Configure TCP server IP and port.

Destination IP Address

Server Address	Server Port	Status	Operation
110.87.98.58	7087		✕
			+

Save

4. Start TCP server on PC. Take **Netassist** test software as example. Make sure port mapping is already done.

Settings

(1) Protocol
TCP Server

(2) Local host IP
192.168.2.27

(3) Local host port
7087

Disconnect

5. Connect the UR32 to PC via RS232 for PLC simulation. Then start **sscom** software on the PC to test communication through serial port.

ComNum COM9 CloseCom

BaudRate 9600 DTR

DataBits 8 Send even 100

StopBits 1 SendHEX

Verify None Data input:

FlowControl None hello

6. After connection is established between the UR32 and the TCP server, you can send data between sscom and Netassist.

PC side

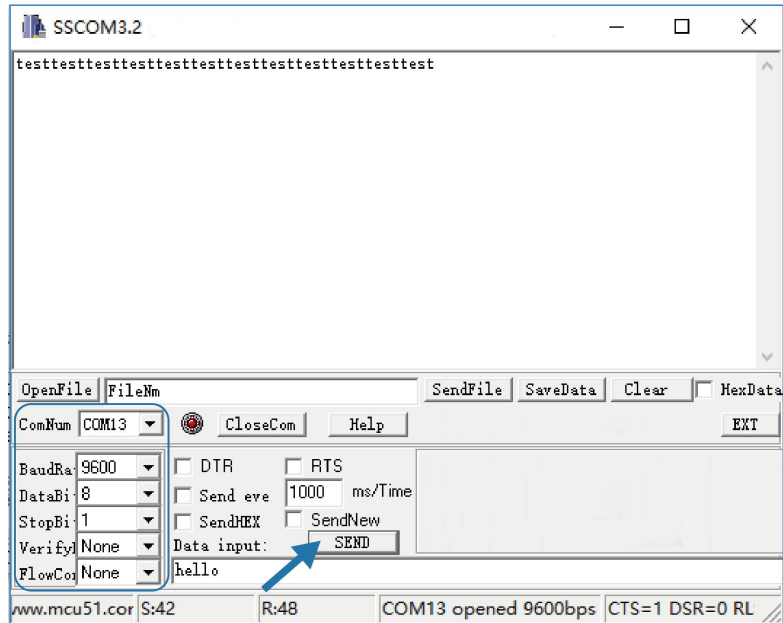

TCP server side

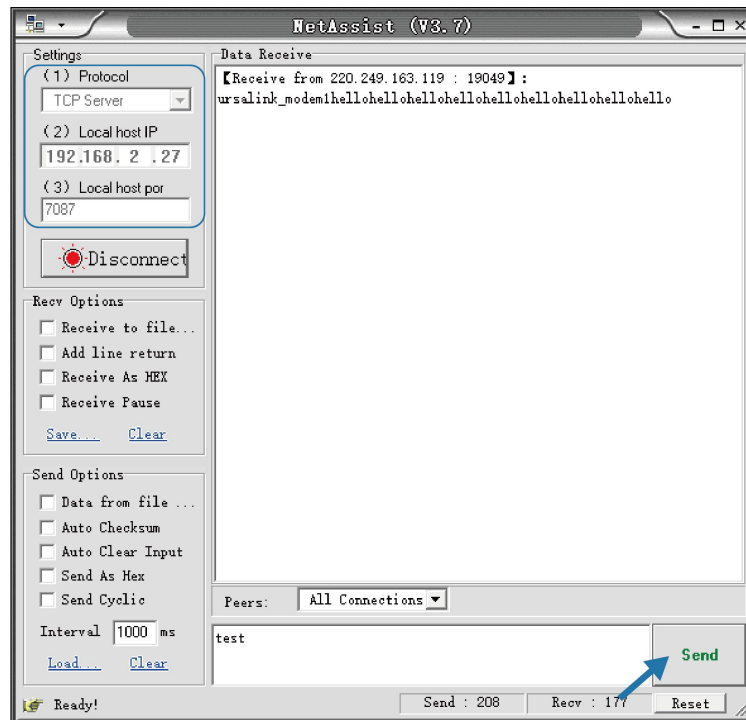

- After serial communication test is done, you can connect PLC to RS232 port of the UR32 for test.

Related Topic

[Serial Port](#)

4.6 Restore Factory Defaults

Method 1:

Log in web interface, and go to **Maintenance > Backup and Restore**, click **Reset** button.

You will be asked to confirm if you'd like to reset it to factory defaults. Then click **Reset** button.

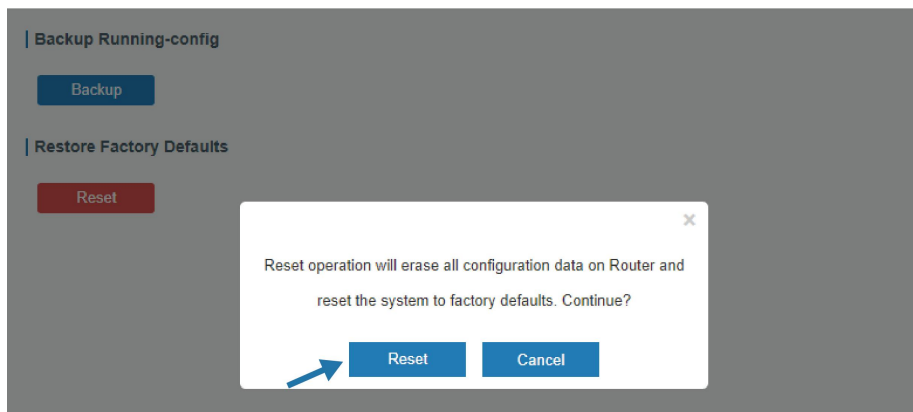
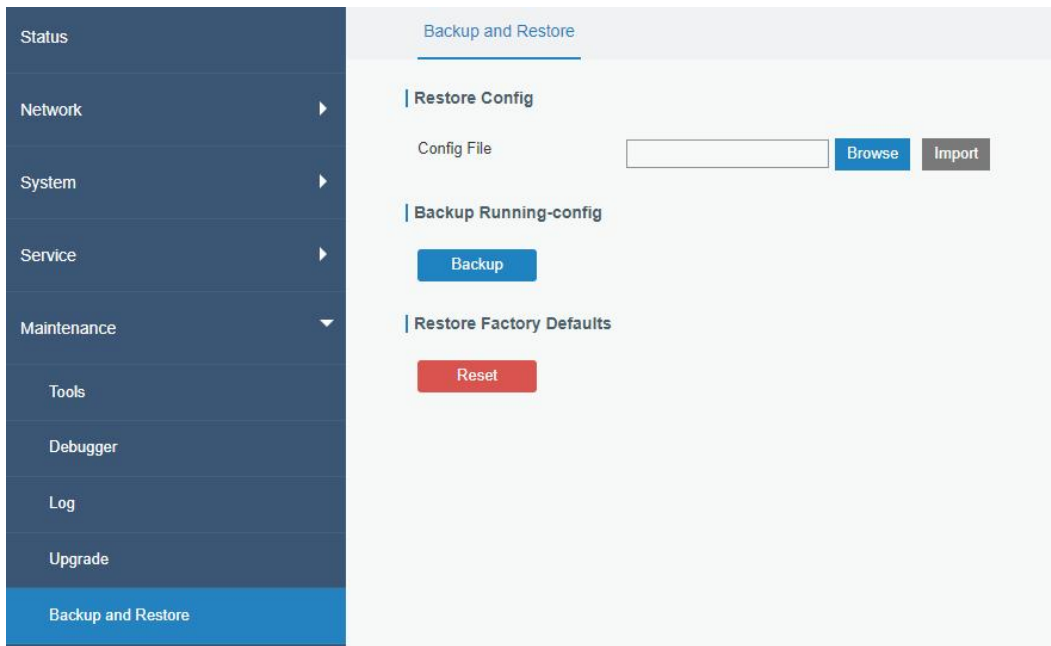

Then the router will reboot and restore to factory settings immediately.

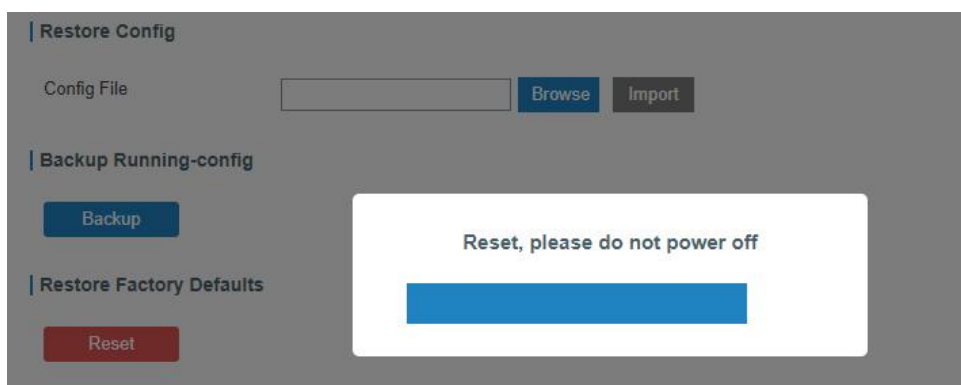

Please wait till the SYSTEM LED blinks slowly and login page pops up again, which means the router has already been reset to factory defaults successfully.

Related Topic

[Restore Factory Defaults](#)

Method 2:

Locate the reset button on the router, press and hold the reset button for more than 5s until the LED blinks.

4.7 Firmware Upgrade

It is suggested that you contact Milesight technical support first before you upgrade router firmware. After getting firmware file please refer to the following steps to complete the upgrade.

1. Go to **Maintenance > Upgrade**, click **Browse** and select the correct firmware file from the PC.
2. Click **Upgrade** and the router will check if the firmware file is correct. If it's correct, the firmware will be imported to the router, and then the router will start to upgrade.

Note: It is recommended to check the box of Reset Configuration to Factory Default before upgrade.

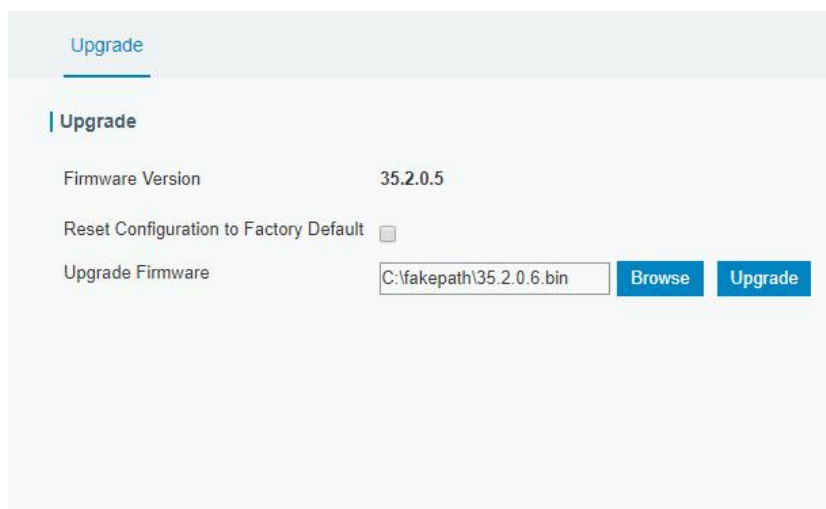

Upgrade

Upgrade

Firmware Version 35.2.0.5

Reset Configuration to Factory Default

Upgrade Firmware C:\fakepath\35.2.0.6.bin

Related Topic

[Upgrade](#)

4.8 SNMP Application Example

Before you configure SNMP parameters, please download the relevant MIB file from the UR32's WEB GUI first, and then upload it to any software or tool which supports standard SNMP protocol. Here we take ManageEngine MibBrowser Free Tool as an example to access the router to query cellular information.

1. Go to **Service > SNMP > MIB** and download the MIB file **LTE-ROUTER-MIB.txt** to PC.

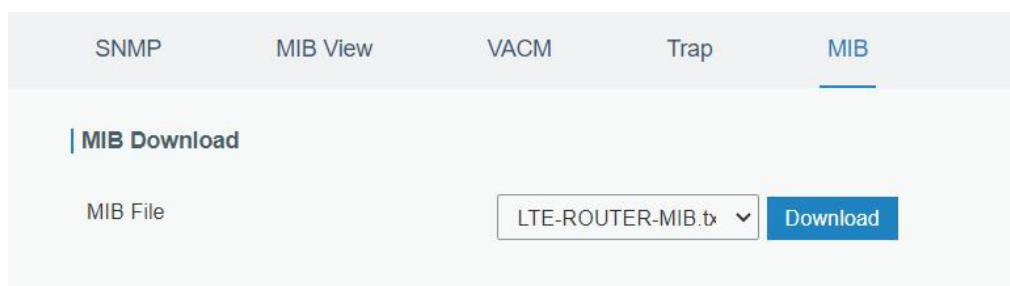

SNMP MIB View VACM Trap MIB

MIB Download

MIB File LTE-ROUTER-MIB.tx

2. Start ManageEngine MibBrowser Free Tool on the PC. Click **File > Load MIB** on the menu bar. Then select **LTE-ROUTER-MIB.txt** file from PC and upload it to the software.

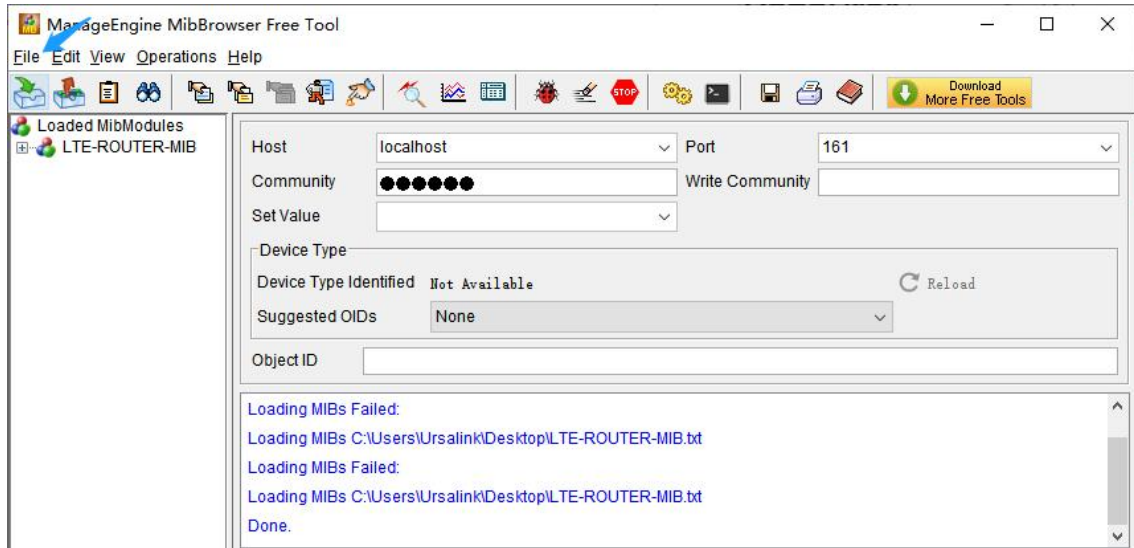

Click the “+” button beside LTE-ROUTER-MIB, which is under the **Loaded MibModules** menu, and find **usCellularInfo**. And then you will see the OID of cellular info is “.1.3.6.1.4.1.50234”, which will be filled in the MIB View settings.

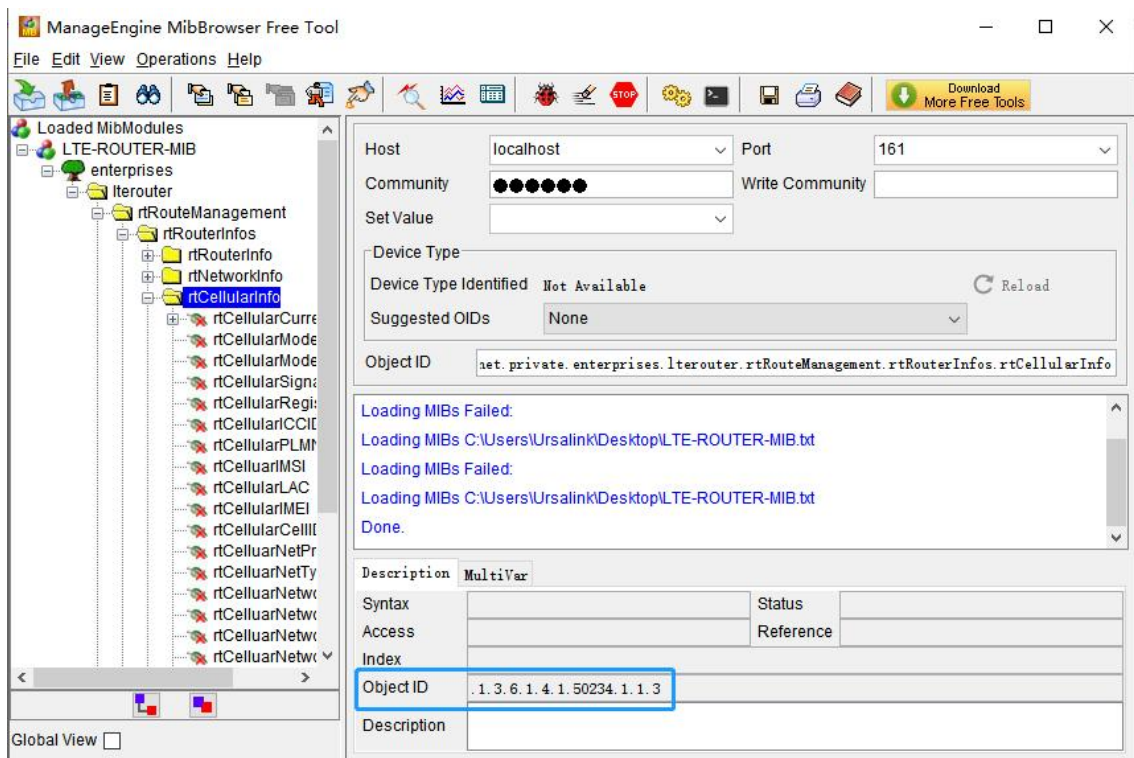

3. Go to **Service > SNMP > SNMP** to enable SNMP feature.

SNMP MIB View VACM Trap MIB

SNMP Settings

Enable

Port

SNMP Version

Location Information

Contact Information

4. Click  to add a new MIB view and define the view to be accessed from the outside network. Then click "Save" button.

SNMP MIB View VACM Trap MIB

View List

View Name	View Filter	View OID	Operation
<input type="text" value="cellular"/>	<input type="text" value="Included"/>	<input type="text" value="1.3.6.1.4.1.50234.1.3"/>	<input type="button" value="X"/>
			<input type="button" value="+"/>

5. Click  to add a new VACM setting to define the access authority for the specified view from the specified outside network, then save all settings.

SNMP MIB View VACM Trap MIB

SNMP v1 & v2 User List

Community	Permission	MIB View	Network	Operation
<input type="text" value="public"/>	<input type="text" value="Read-Write"/>	<input type="text" value="cellular"/>	<input type="text" value="0.0.0.0/0"/>	<input type="button" value="X"/>
				<input type="button" value="+"/>

6. Go to MibBrowser, enter host IP address, port and community. Right click **usCellular CurrentSim** and then click **FET**. Then you will get the current SIM info on the result box. You can get other

cellular info in the same way.

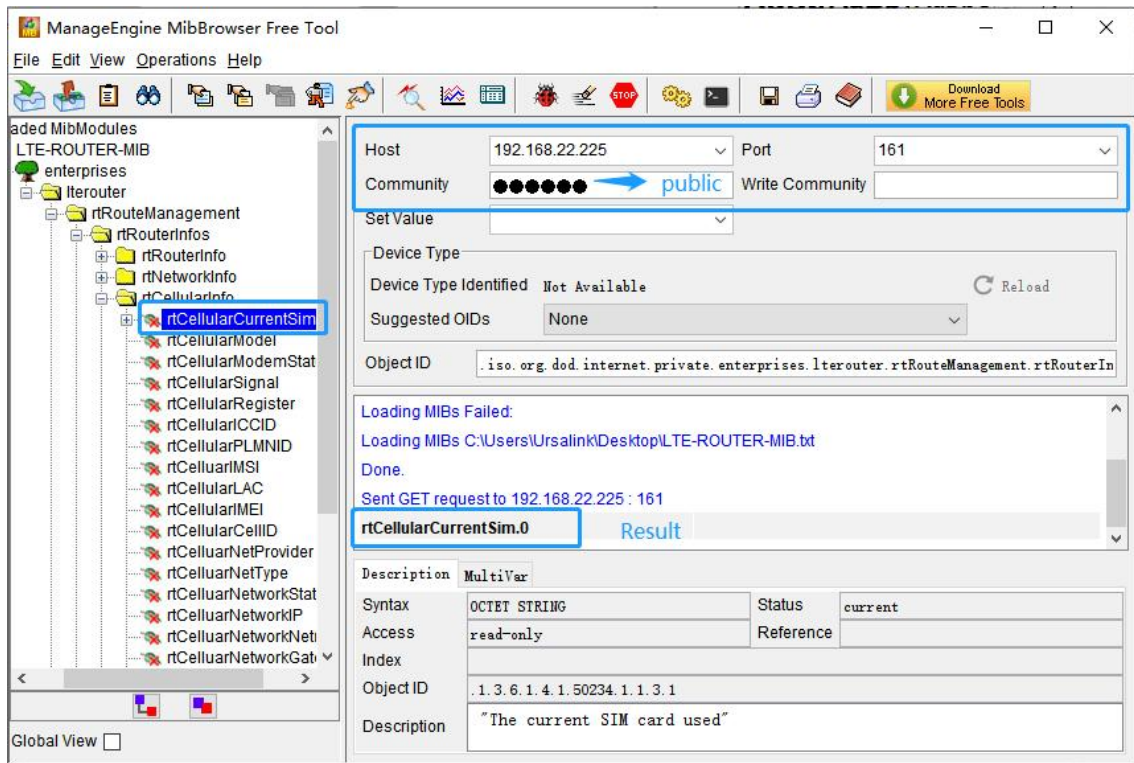

Related Topic

[SNMP](#)

4.9 VRRP Application Example

Application Example

A Web server requires Internet access through the UR32 router. To avoid data loss caused by router breakdown, two UR32 routers can be deployed as VRRP backup group, so as to improve network reliability.

VRRP group:

WAN ports of the UR32 Router A and Router B are connected to the Internet via wired network. And LAN ports of them are connected to a switch.

Virtual IP is 192.168.1.254/24.

Router	Virtual Router ID (Same for A and B)	Port connected with switch	LAN IP Address	Priority	Preemption Mode
A	1	LAN2	192.168.1.1	110	Enable
B	1	LAN2	192.168.1.2	100	Disable

Refer to the topological below.

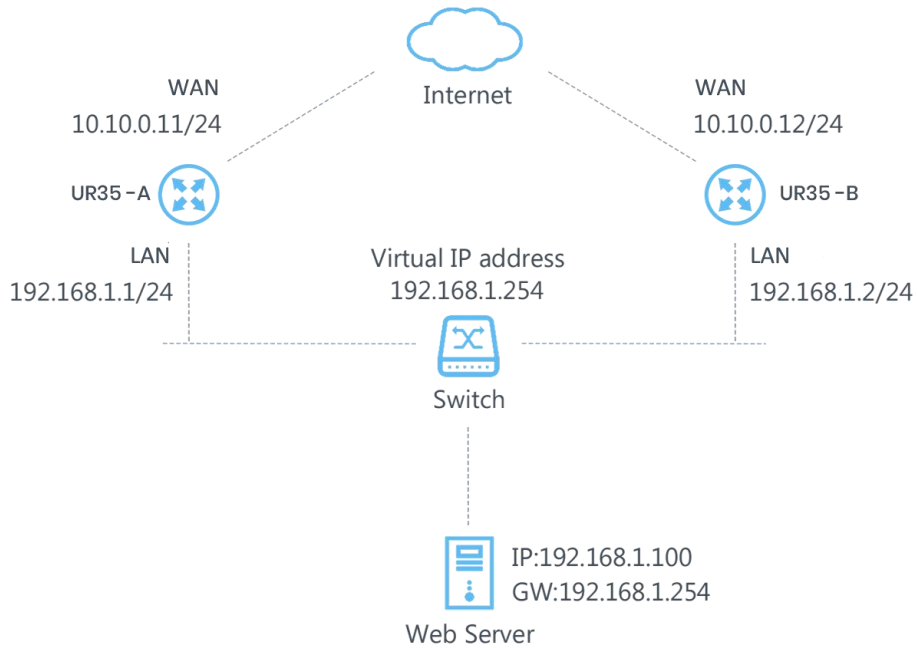

Configuration Steps

Router A Configuration

1. Go to **Network > Interface > WAN** and configure wired WAN connection as below.

Link Failover	Cellular	Port	WAN	Bridge
WAN Settings				
— WAN_1				
Enable	<input checked="" type="checkbox"/>			
Port	LAN1/WAN			
Connection Type	Static IP			
IPv4 Address	10.10.0.11			
Netmask	255.255.255.0			
IPv4 Gateway	10.10.0.1			
IPv6 Address	fe80::26e1:24ff:fe0:3192			
Prefix-length	64			
IPv6 Gateway				
MTU	1500			
Primary DNS	8.8.8.8			
Secondary DNS				
Enable NAT	<input checked="" type="checkbox"/>			

2. Go to **Network > VRRP > VRRP** and configure VRRP parameters as below.

VRRP

VRRP Status

Status DISABLE

VRRP Settings

Enable

Interface Bridge0

Virtual Router ID 1

Virtual IP 192.168.1.254

Priority 110

Advertisement Interval (s) 1

Preemption Mode

IPv4 Primary Server 8.8.8.8

IPv4 Secondary Server 114.114.114.114

Interval 300 s

Retry Interval 5 s

Timeout 3 s

Max Ping Retries 3

Router B Configuration

1. Go to **Network > Interface > WAN** and configure wired WAN connection as below.

Link Failover Cellular Port **WAN** Bridge

WAN Settings

— WAN_1

Enable

Port LAN1/WAN

Connection Type Static IP

IPv4 Address 10.10.0.12

Netmask 255.255.255.0

IPv4 Gateway 10.10.0.1

IPv6 Address fe80::26e1:24ff:fe0:3192

Prefix-length 64

IPv6 Gateway

MTU 1500

Primary DNS 8.8.8.8

Secondary DNS

Enable NAT

2. Go to **Network > VRRP > VRRP** and configure VRRP parameters as below.

VRRP

Status DISABLE

VRRP Settings

Enable

Interface Bridge0

Virtual Router ID 1

Virtual IP 192.168.1.254

Priority 100

Advertisement Interval (s) 1

Preemption Mode

IPv4 Primary Server 8.8.8.8

IPv4 Secondary Server 114.114.114.114

Interval 300 s

Retry Interval 5 s

Timeout 3 s

Max Ping Retries 3

Once you complete all configurations, click **Apply** button on the top-right corner to make changes take effect.

Result: normally, A is the master router, used as the default gateway. When the power of Router A is down or Router A suffers from failure, Router B will become the master router, used as the default gateway. With Preemption Mode enabled, Router A will be master and Router B will demote back to be the backup once Router A can access the Internet again.

Related Topics

[VRRP Setting](#)

4.10 QoS Application Example

Example

Configure the UR32 router to distribute local preference to different FTP download channels. The total download bandwidth is 75000 kbps.

Note: the “Total Download Bandwidth” should be less than the real maximum bandwidth of WAN or cellular interface.

FTP Server IP & Port	Percent	Max Bandwidth(kbps)	Min Bandwidth(kbps)
110.21.24.98:21	40%	30000	25000
110.32.91.44:21	60%	45000	40000

Configuration Steps

- Go to **Network > QoS > QoS(Download)** to enable QoS and set the total download bandwidth.

Download Bandwidth

Enable

Default Category

Download Bandwidth kbits/s

Capacity

- Click “+” to set up service classes.

Note: the percents must add up to 100%.

Service Category

Name	Percent(%)	Max BW(kbps)	Min BW(kbps)	Operation
<input type="text" value="1"/>	<input type="text" value="40"/>	<input type="text" value="30000"/>	<input type="text" value="25000"/>	<input type="button" value="X"/>
<input type="text" value="2"/>	<input type="text" value="60"/>	<input type="text" value="45000"/>	<input type="text" value="40000"/>	<input type="button" value="X"/>
				<input type="button" value="+"/>

- Click “+” to set up service category rules.

Service Category Rules

Name	Source IP	Source Port	Destination IP	Destination Port	Protocol	Service Category	Operation
<input type="text" value="ftp1"/>	<input type="text" value="110.21.24.98"/>	<input type="text" value="21"/>	<input type="text"/>	<input type="text"/>	<input type="text" value="ANY"/>	<input type="text" value="1"/>	<input type="button" value="X"/>
<input type="text" value="ftp2"/>	<input type="text" value="110.32.91.44"/>	<input type="text" value="21"/>	<input type="text"/>	<input type="text"/>	<input type="text" value="ANY"/>	<input type="text" value="2"/>	<input type="button" value="X"/>
							<input type="button" value="+"/>

Note:

IP/Port: null refers to any IP address/port.

Click **Save** and **Apply** button.

Related Topic

[QoS Setting](#)

[END]