



X5 Sensing Camera

SC311

User Guide



Chapter 1. Introduction	3
1.1 Copyright Statement.....	3
1.2 Safety Instruction.....	3
1.3 Revision History.....	4
Chapter 2. Product Description	5
2.1 Product Overview.....	5
2.2 Hardware Overview.....	6
2.3 Installation Guide.....	9
Chapter 3. Accessing the Camera	11
Chapter 4. Home	14
Chapter 5. Status	15
Chapter 6. Network	17
6.1 Cellular.....	17
6.2 WLAN.....	19
Chapter 7. Object Capture	20
7.1 Image Configuration.....	21
7.2 Capture Management.....	23
7.3 Interface Configuration.....	27
Chapter 8. System	28
8.1 System info.....	28
8.2 Date&Time.....	29
8.3 User.....	29
8.4 Security Service.....	30
8.5 Storage.....	31
8.6 System Maintenance.....	32
Chapter 9. Communication Protocol	33

Chapter 1. Introduction

Thank you for purchasing our product. If there is any question or request, please do not hesitate to contact your dealer.

This guide may contain several technically incorrect places or printing errors, and the content is subject to change without notice. The updates will be added into the new version of this guide. We will readily improve or update the products or procedures described in the guide.

This guide explains how to use and manage Milesight X5 Sensing Camera. Please read this guide carefully before the operation and retain it for future reference.

1.1 Copyright Statement

This guide may not be reproduced in any form or by any means to create any derivative such as translation, transformation, or adaptation without the prior written permission of Xiamen Milesight IoT Co., Ltd (Hereinafter referred to as Milesight).

Milesight reserves the right to change this manual and the specifications without prior notice. The latest specifications and user documentation for all Milesight products are available on our official website <http://www.milesight.com>

1.2 Safety Instruction

Milesight will not shoulder responsibility for any loss or damage resulting from not following the instructions of this operating guide.

- ❖ The device must not be disassembled or remodeled in any way.
- ❖ To avoid risk of fire and electric shock, do keep the product away from rain and moisture before installation.
- ❖ Do not place the device where the temperature is below/above the operating range.
- ❖ The device must never be subjected to shocks or impacts.
- ❖ Make sure the device is firmly fixed when installing.
- ❖ The battery should be removed from the device if it is not to be used for an extended period. Otherwise, the battery might leak and damage the device. Never

leave a discharged battery in the battery compartment.

- ❖ Make sure all batteries are newest when install, or battery life will be reduced.
- ❖ Do not expose the device to where a laser beam equipment is used.

Declaration of Conformity

SC311 is in conformity with the essential requirements and other relevant provisions of the CE, FCC, and RoHS.



Copyright © 2011-2024 Milesight. All rights reserved.

All information in this guide is protected by copyright law. Whereby, no organization or individual shall copy or reproduce the whole or part of this user guide by any means without written authorization from Xiamen Milesight IoT Co., Ltd.

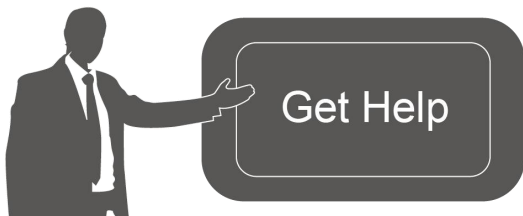

For assistance, please contact

Milesight technical support:

Email: iot.support@milesight.com

Support Portal: support.milesight-iot.com

Tel: 86-592-5085280

Fax: 86-592-5023065

Address: Building C09, Software Park Phase

III, Xiamen 361024, China

1.3 Revision History

Table 1.

Version	Revision Content	Release Date
V1.0	Initial version	September 2023
V1.1	Update based on version 31.1.0.2: 1. Change default password from password to ms123456 2. Add time sync mode: Auto 3. Update web GUI display	March 21, 2024

Chapter 2. Product Description

2.1 Product Overview

X5 Sensing Camera is a cutting-edge AIoT device that leverages active sensing to enable intelligent and versatile applications. It comes equipped with a high-advanced image sensor and customizable capturing modes that can deliver high-quality images for a range of scenarios. The X5 also features embedded low-consumption radar and PIR sensors which provide greater sensitivity. Additionally, the camera has temperature and sound sensors that allow for environmental sensing.

Moreover, X5 features wireless connectivity and simple configuration options for easy integration into specific environments. The low-consumption mode and optional solar panel extend its operational life and increase cost-effectiveness. With IP66-rated protection and anti-theft design, the X5 opens up a wealth of potential applications.

X5 Sensing Camera supports simple configuration via Wi-Fi and facilitates remote management and data transmission via standard MQTT(s) and HTTP protocols to Milesight AIoT Sensing Platform and third-party platforms.











Key Features

- **High-quality Capturing System**
 - ✧ Detect the moving objects actively cooperating with PIR and Radar
 - ✧ Support multi-type picture-capturing modes depending on various kinds of triggering sources: radar & PIR, temperature, sound, alarm-in, etc.
 - ✧ Equip with one advanced infrared supplement light to increase light level in dark environments and improve the sensitivity for capturing objects from up to 10m distance
 - ✧ Provide full HD resolution of 1920 x 1080 pixels and adjustable picture parameters
- **High Adaptability & Reliability**

- ✧ Provide all-in-one camera bracket and rain cover for more simple installation options
 - ✧ Support multi-type power supply and additional solar panel for outdoor application
 - ✧ Smart sleep-mode logic and low-power consumption provide it a longer service life
 - ✧ Equip with heating film for protecting battery in low-temperature environment
 - ✧ Support IP66 rated protection and anti-theft screw design for adapting to more scenarios
- **Easy Management & Deployment**
 - ✧ Wireless deployment with stable 4G network
 - ✧ Support easy configuration via wireless Wi-Fi connection
 - ✧ Support data transmission via HTTP/MQTT(S)
 - ✧ Adapt to more applications with rich industrial interfaces
 - ✧ Support remote management with Milesight AIoT Sensing Platform for extending applications

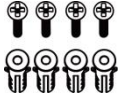
2.2 Hardware Overview

Packing List

 <p>X5 Sensing Camera × 1</p>	 <p>3-Axis Ball Mounting Bracket × 1 Screw of Bracket × 1</p>	 <p>Multi-Interface Cable (0.5m) × 1</p>	 <p>USB Type-C Charging Cable × 1</p>
 <p>Solar Panel Modules (Optional)</p>	 <p>Screwdriver × 1</p>	 <p>Strap × 2</p>	 <p>Screw Packet × 1</p>
 <p>SIM Card Ejector Tool × 1</p>	 <p>Quick Start Guide × 1</p>	 <p>Warranty Card × 1</p>	

※ If any of the above items is missing or damaged, please contact your sales representative.

Hardware

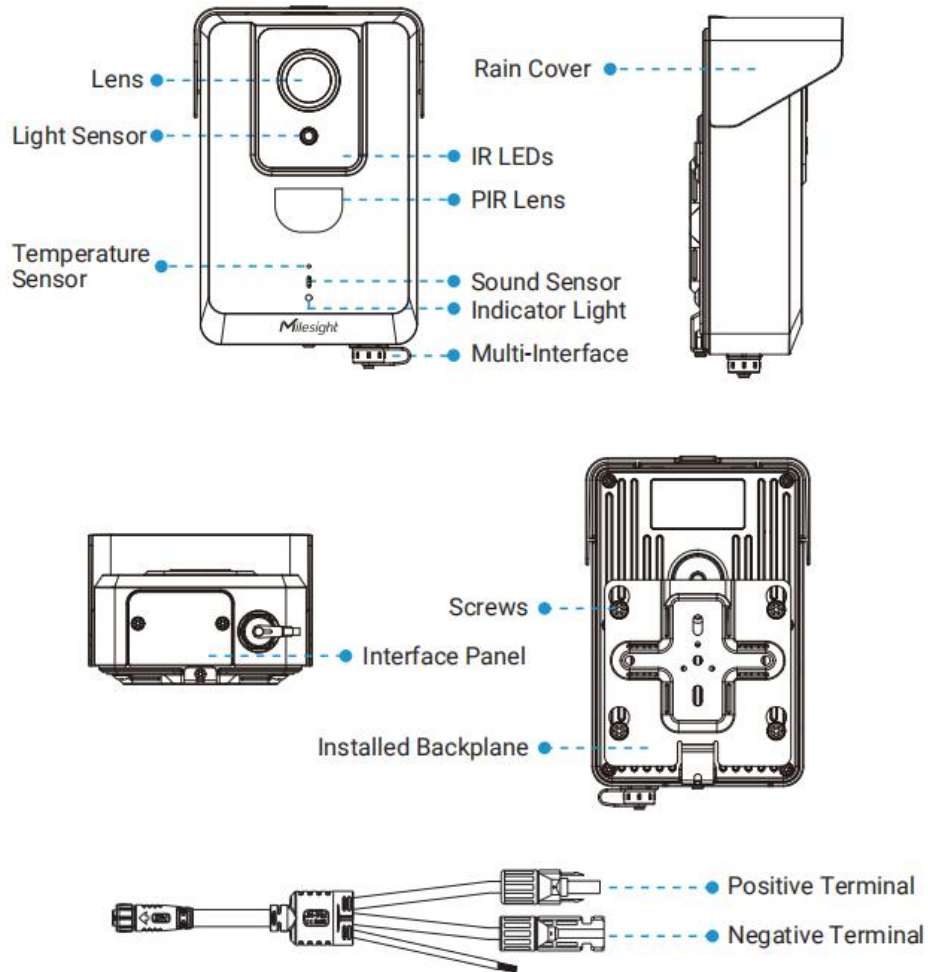

Note: The Positive Terminal of the solar panel cable needs to be connected to the Negative Terminal of the solar panel, and the Negative Terminal needs to be connected to the Positive Terminal of the solar panel.

Interface

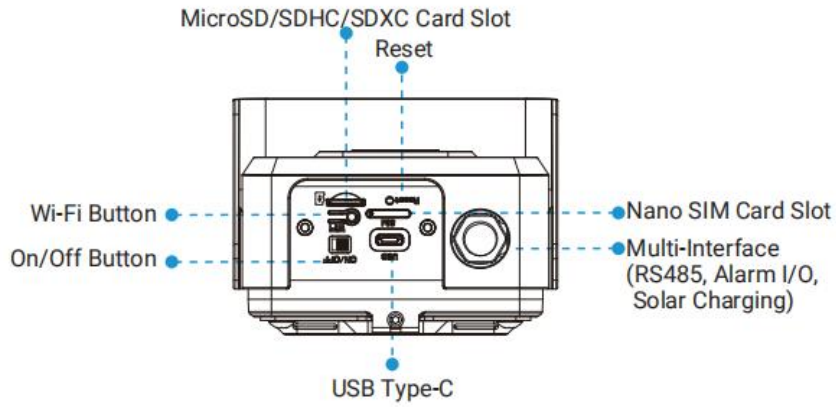

Dimensions(mm)

SC311

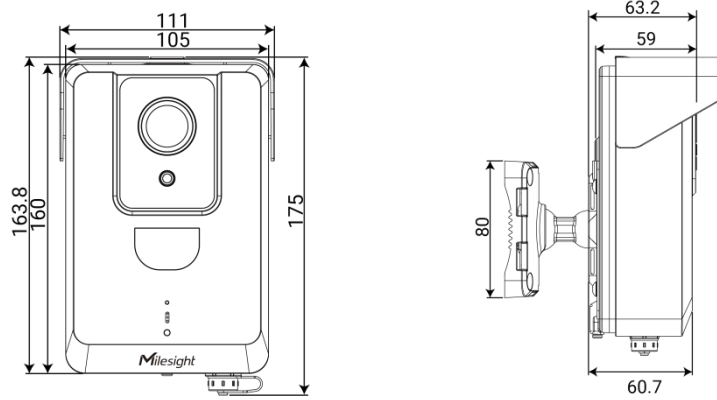

3-Axis Ball Mounting Bracket

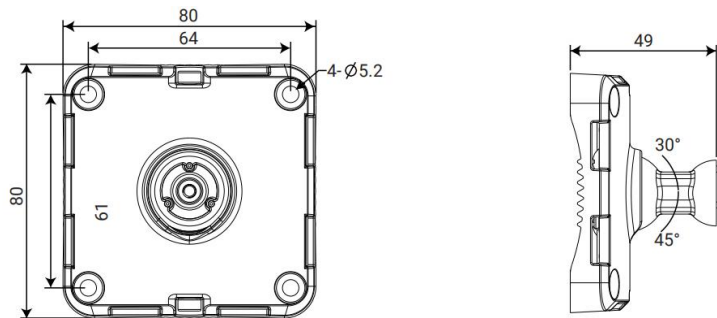

Backplane

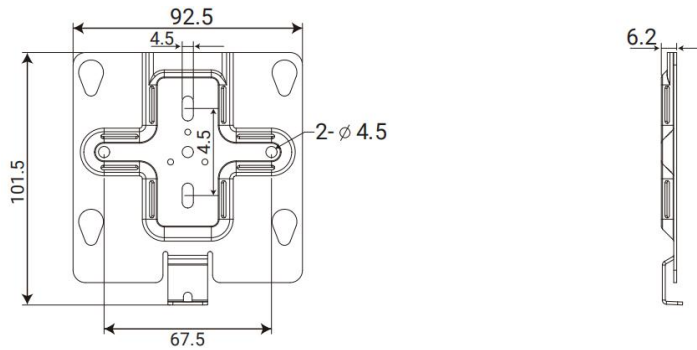

2.3 Installation Guide

Step 1: Loosen the screw at the bottom of the backplane and remove the backplane.

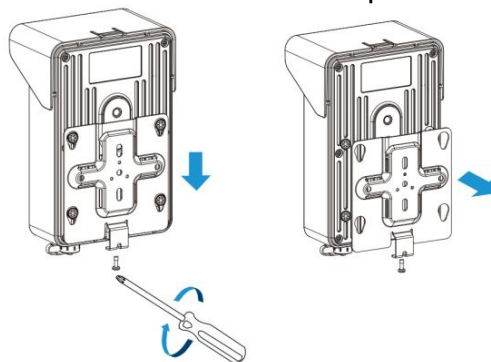

Step 2: Fix the backplane in the position where the device is intended to be installed. Multiple installation methods are available depending on the installation location:

- 1) The device can be mounted directly on the wall, or you can mount it on the wall via 3-Axis Ball Mounting Bracket.

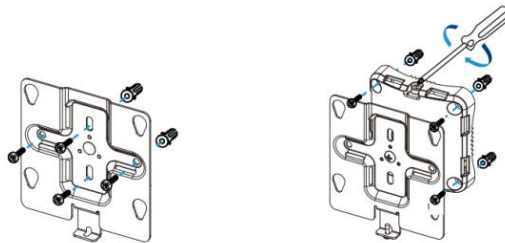

- 2) The device can be mounted on the pole with the straps, or you can install the device on the pole with 3-Axis Ball Mounting Bracket and straps.

Note:

1. The 3-Axis Ball Bracket allows the equipment to rotate 360° to adjust the monitoring angle, it in various installation environments.
2. The angle of the 3-Axis Ball Bracket can be adjusted by loosening the screw on the bracket.

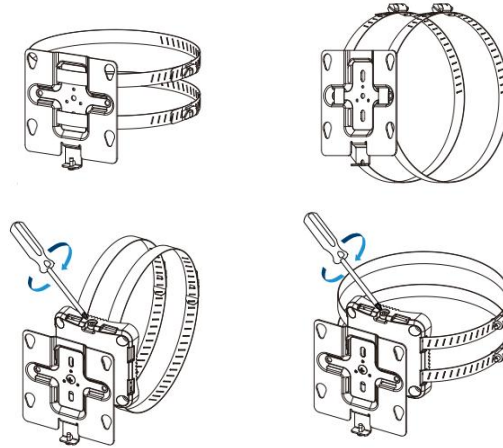

Step 3: Loosen the screws of Interface Panel and remove the cover. Then remove the Solar Charging Interface cover.

Step 4: Use the SIM Card Ejector Tool to remove the SIM card tray, and then install the SIM Card and SD Card.

Note: If you need to configure the device, please refer to [Chapter 3. Accessing the Camera](#).

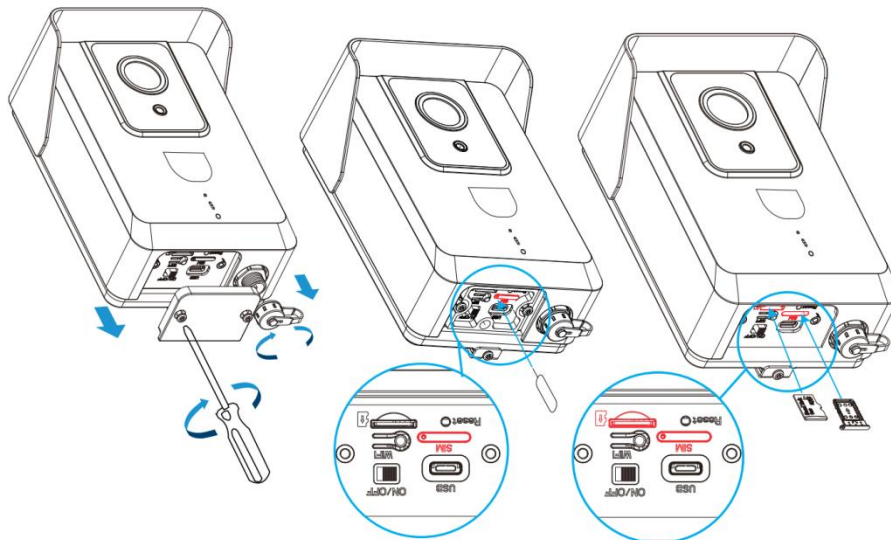

Step 5: Put the interface panel back.

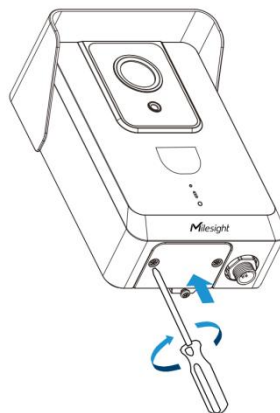

Step 6: Install the solar panel modules in the appropriate position.

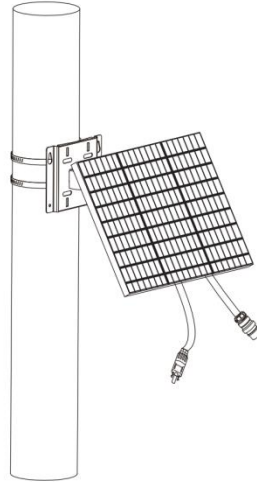

Step 7: Connect the solar panel to the Solar Charging Interface.

Note:

1. The Solar Panel Modules is optional.
2. The device is equipped with battery inside. When the solar power supply is insufficient, it can be powered by battery; When the battery is low, it can be charged using USB Type-C.

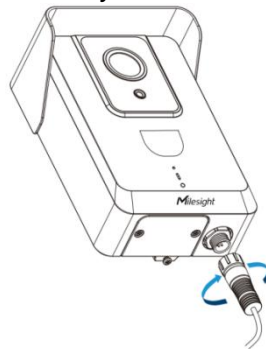

Step 8: Connect the device to the backplane that you've installed already and tighten the fixing screws. Then the installation is completed.

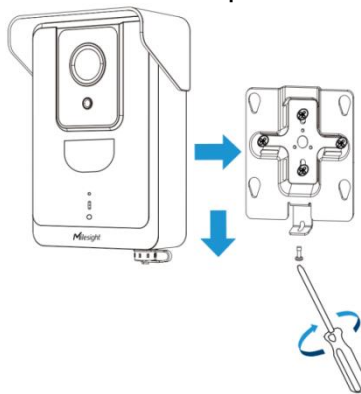

Chapter 3. Accessing the Camera

After installing the camera, you need to log in the camera's web page for basic

configuration so that the camera can capture objects accurately. The camera can be used with most standard operating systems and browsers.

The configuration steps are as follows:

Step 1: Switch to “ON” to start the device.

Note:

1. When you power on the device, the indicator will blink in green if the device is started. And when you turn off the device, the indicator will blink in green twice and then stop blinking. The Wi-Fi function is automatically enabled when the device is powered on.
3. The indicator light will be in red when the device is low power and cannot be started.

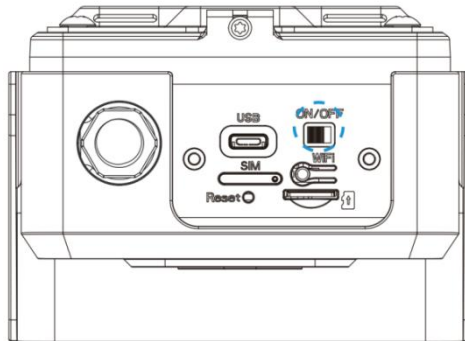

Step 2: Use mobile devices or laptop to connect to the device's Wi-Fi.

Note: The Wi-Fi name is **SC311_XXXXXX** (XXXXXX is the last six bits of the MAC address).

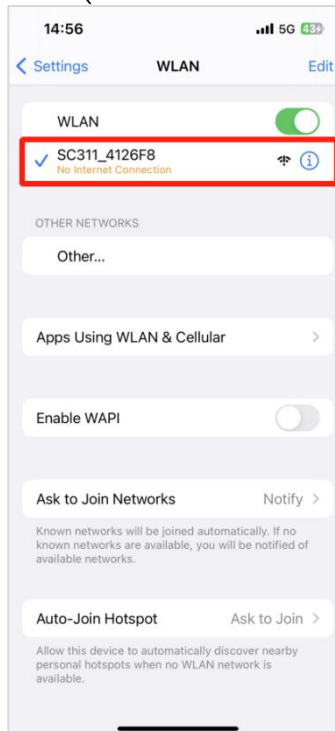

Step 3: Enter the IP address **192.168.1.1** in the browser to log in to the web page and configure the device.

Note:

1. Default **Username/Password: admin/ms123456**.
2. The IP address of the device cannot be modified.

- Mobile:



- PC:

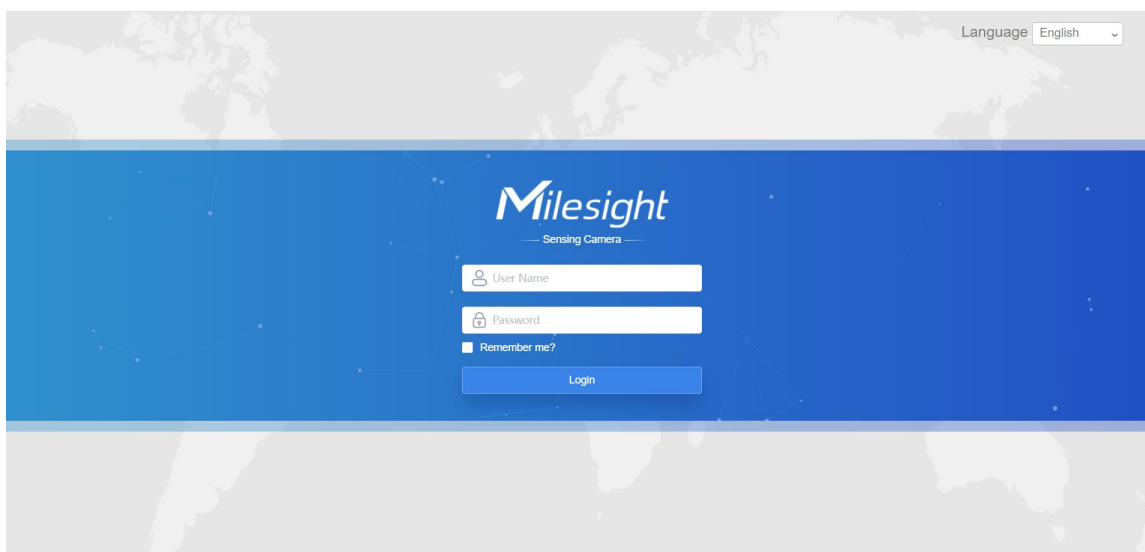

Step 4: After the device configuration is completed, click the Wi-Fi button to disable the Wi-Fi and fix back the interface panel to ensure data security.

Note: To reset the device, you can press the reset button for 3s. When the reset process is completed, the indicator will blink in green twice.

1. Short press the reset button (for about 1s) to restart the device.
2. Long press the reset button (for about 15s or less) until the red light is steady on and release it to reset the device.
3. Long press the reset button (for about 20s or more) until the red light flashes and release it to overwrite the existing firmware with the original firmware.

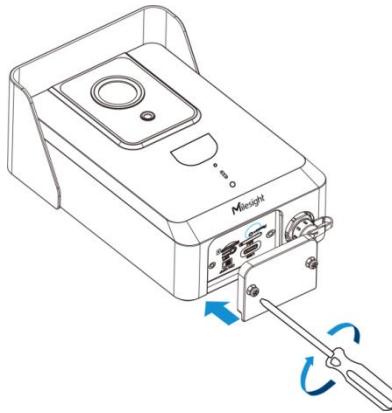

Chapter 4. Home

After logging in to the camera web GUI successfully, the user is allowed to view the home page as follows.

- Mobile:

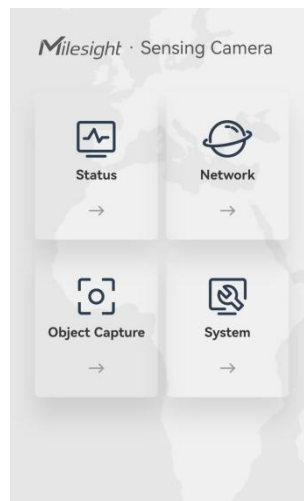

- PC:

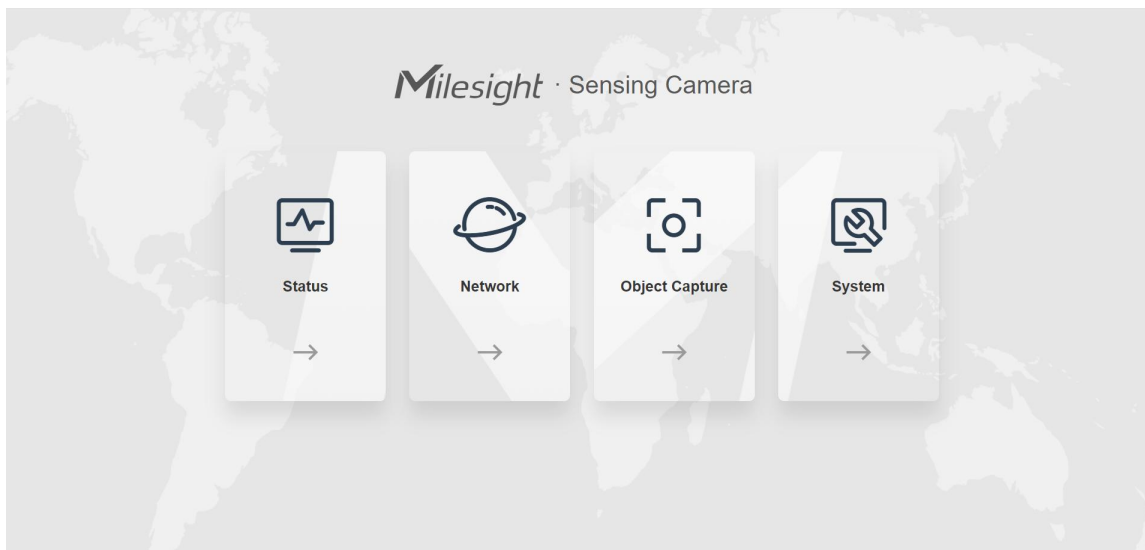

The home page consists of four modules including Status, Network, Object Capture and System.

1. **Status:** Check device status, including Power Supply and GPS-related information, environment information and etc.
2. **Network:** Configure the network configuration, including Cellular and WLAN.
3. **Object Capture:** Includes Image Configuration, Capture Management and Interface Configuration. Image Configuration is used to configure image parameters to ensure the quality of captured images, and Capture Management is mainly used to configure Capture Settings and Upload Settings, such as Detection Mode, Upload Mode, Frequency, Sensitivity, etc., with the purpose of capturing and uploading the snapshots more accurately. Interface Configuration is used to view the current status of external input and external output and configure the threshold of noise and temperature.
4. **System:** Check and maintain system information, manage snapshots and users, etc.

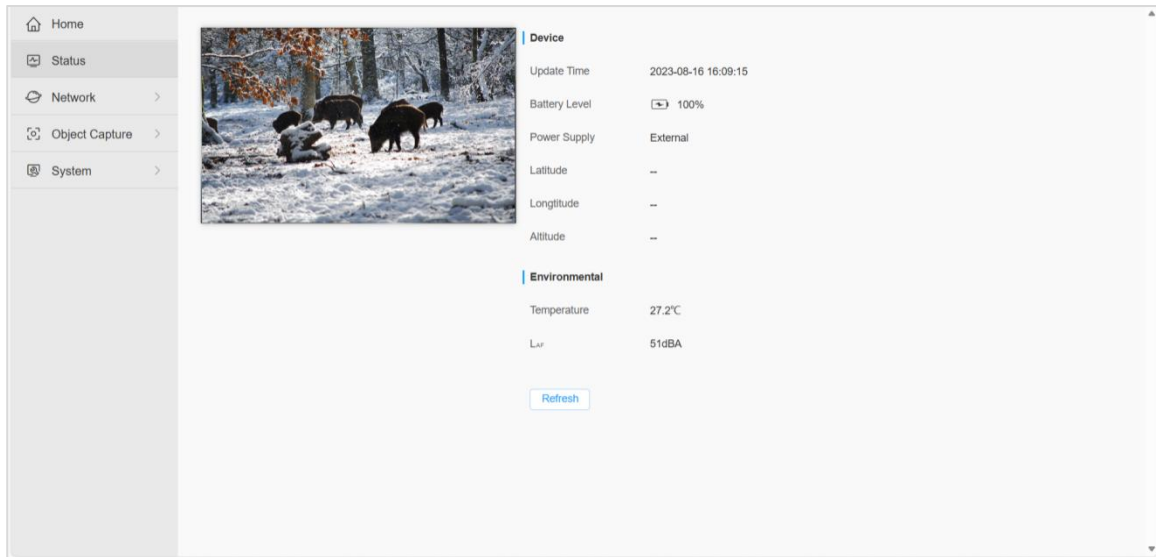

Chapter 5. Status

Users can check device status in this interface, including Power Supply and GPS-related information, environment information and etc.



The meanings of the items can be referred to the table below:

Table 2. Description of the buttons

Item	Description	
Update Time	Display the last time the Status page was refreshed.	
Battery Level	Display the real-time battery level, the meaning of the visual icon is as follows:  : Charging  : Low Battery (Battery power is less than 10%)	
Power Supply	Display how the device is powered. Internal and External options are available. Internal: Powered by battery. External: Powered by solar panel or external power supply via Type-C. The power supply mechanism of the device is as follows: <ul style="list-style-type: none"> ◇ When equipped with an external power supply, priority will be given to powering the device, and only when there is excess power will the battery be charged. ◇ When both internal and external power supplies are equipped, priority will be given to using external power supplies to power the device. (Type-C > Solar Panel > Battery). Note: If the device is equipped with a solar panel but the solar panel is low on power, then the device will be powered by the battery.	
Latitude /Longitude /Altitude	Display the GPS-related information of the device including latitude, longitude and altitude. It is detected by the GPS module attached to the device. Note: GPS information will only be displayed when the device is inserted with a SIM card and access the network successfully.	
Environmental	Temperature	Display the temperature information around the device. It is detected by the Temperature Sensor attached to the device.
	LAF	Display the sound information around the device. It is detected by the Sound Sensor attached to the device.

 Refresh

Click this button to refresh all the above states.

Note: The preview window on the interface shows the real-time image after refreshing the device status but not the real-time video. Please note that the device is running under low power consumption since there is no video streaming being produced.

Chapter 6. Network

6.1 Cellular

You can check the cellular status and configure the cellular settings here. The configuration steps are as follows:

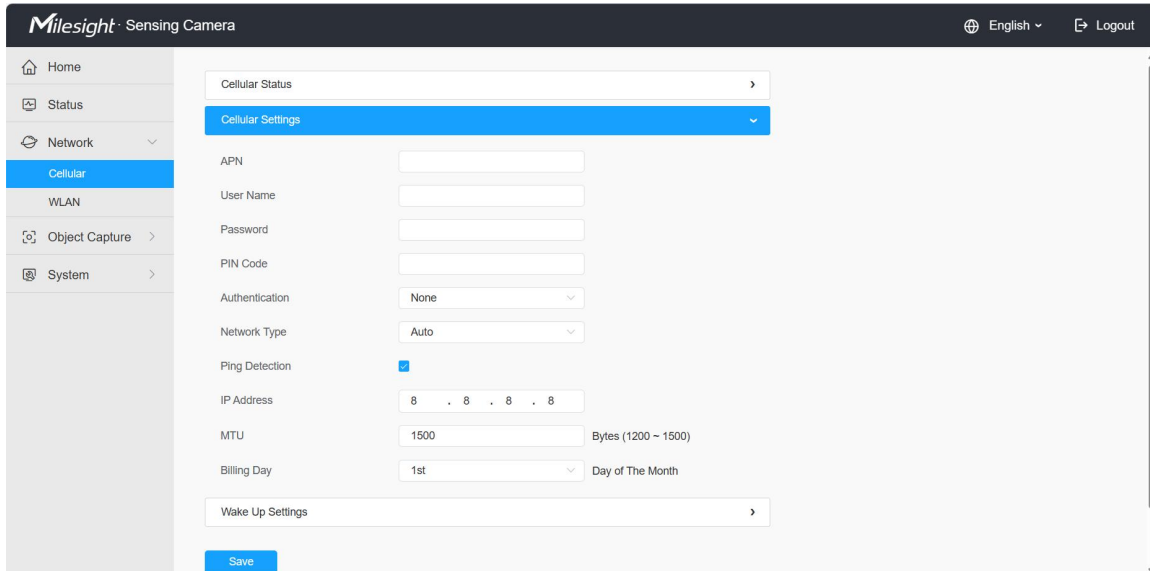

The screenshot shows the Milesight Sensing Camera web interface. The top navigation bar includes the Milesight logo, 'Sensing Camera', a language dropdown (English), and a Logout button. The left sidebar contains navigation links: Home, Status, Network (expanded), Cellular (selected), WLAN, Object Capture, and System. The main content area displays the Cellular Settings page, which includes a 'Cellular Status' dropdown, a 'Cellular Settings' dropdown, and several configuration fields: APN, User Name, Password, PIN Code, Authentication (None), Network Type (Auto), Ping Detection (checked), IP Address (8.8.8.8), MTU (1500 Bytes), and Billing Day (1st Day of The Month). A 'Wake Up Settings' dropdown and a 'Save' button are also visible at the bottom.

Step1: Fill in the information provided by your Internet Service Provider (ISP) to the Cellular Settings interface, then click Save to access the network successfully.

Please refer to the meaning of the options as follows:

Table 3. Description of the buttons

Item	Description
APN	Enter the Access Point Name for cellular dial-up connection provided by local ISP.
User Name	Enter the username for cellular dial-up connection provided by local ISP.
Password	Enter the password for cellular dial-up connection provided by local ISP.

PIN Code	Enter a 4-8 characters PIN code to unlock the SIM.
Authentication	Display the Authentication Type.
Network Type	Select the network type of cellular network. There are four options including Auto, 4G Only, 3G Only and 2G Only, the default option is Auto. Auto: connect to the network with the strongest signal automatically.
Ping Detection	Enable it to determine network communication latency.
IP Address	The default is 8.8.8.8.
MTU	Enter maximum transmission unit the range is 1200~1500 Bytes.
Billing Day	Select the date for clearing the data each month. Users can choose from 1st to 31st, and the system will clear the data on the date you set each month.

Note: For some Internet Service Providers, users only need to insert the SIM card directly to access the network without additional configuration.

Step2: After connecting to the network successfully, you can check the cellular status information on the Cellular Status interface, as shown below.

Please refer to the meaning of the options as follows:

Table 4. Description of the buttons

Item	Description
ISP	Show the network provider which the SIM card registers on. Note: It will display "-" when the SIM card is not inserted or not recognized.
SIM Card Status	Display the connection status of SIM card, including 4G Connected, 3G Connected, 2G Connected, No SIM Card and SIM Card Invalid.
Signal Strength	Display the current signal strength of the network.
Status	Display the connection status of the network, including "connect" and "disconnect".
IMEI	Show the IMEI of the module.
IMSI	Show IMSI of the SIM card.
ICCID	Show ICCID of the SIM card
Data Usage Monthly	Display current monthly used data.

IP Address	Display the IP Address, Subnet Mask, Gateway and DNS Address of the current network. If the SIM card is not inserted or not recognized, it will display 0.0.0.0.
Subnet Mask	
Gateway	
DNS Address	
<input type="button" value="Refresh"/>	Click this button to manually refresh the above status.

Note:

1. The camera supports the wake-up function. When the battery power is less than 10%, the device will automatically enter sleep mode. The user can wake up the device via Bluetooth, MQTT or dialing the SIM card.
2. The MQTT wake up method is to send any content to "X5SensingCam/Wake/xxxxxxxxxxxxxx" topic to wake up device. (The xxxxxxxxxxxxxx is the MAC address of device.)

Wake up settings

Wake up method

Bluetooth Call MQTT

Save

6.2 WLAN

In this interface, the user can configure WLAN-related settings and then access the device via WiFi for device configuration. The configuration through Wi-Fi enhances the user experience for great convenience.

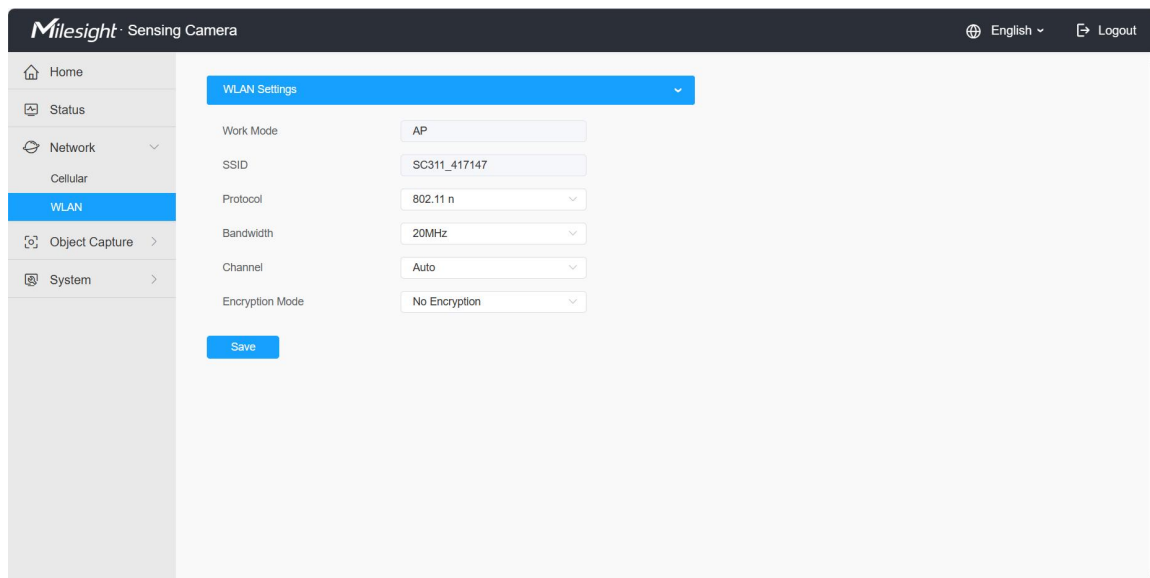

Please refer to the meaning of the options as follows:

Table 5. Description of the buttons

Item	Description
Work Mode	Work mode is fixed as AP and can not be connected to other access point.
SSID	The unique name for this device Wi-Fi access point, defined as SC311_XXXXX (XXXXX is the last six bits of the MAC address). Note: The Wi-Fi name cannot be modified.
Radio Type	802.11g (2.4 GHz) and 802.11n (2.4 GHz) are optional.
Bandwidth	20 MHz or 40 MHz are optional.
Channel	Select the wireless channel. Auto, 1,...11 are optional.
Encryption Mode	No Encryption, WPA-PSK, WPA2-PSK and WPA-PSK/WPA2-PSK are optional.
Cipher	AES, TKIP and AES/TKIP are optional.
Key	Fill in the password of this Wi-Fi access point.

Note: The function can be disabled by pressing the WiFi button on the device to eliminate possible worries of privacy disclosure.

Chapter 7. Object Capture

7.1 Image Configuration

Here you can configure image parameters to ensure the quality of captured images.

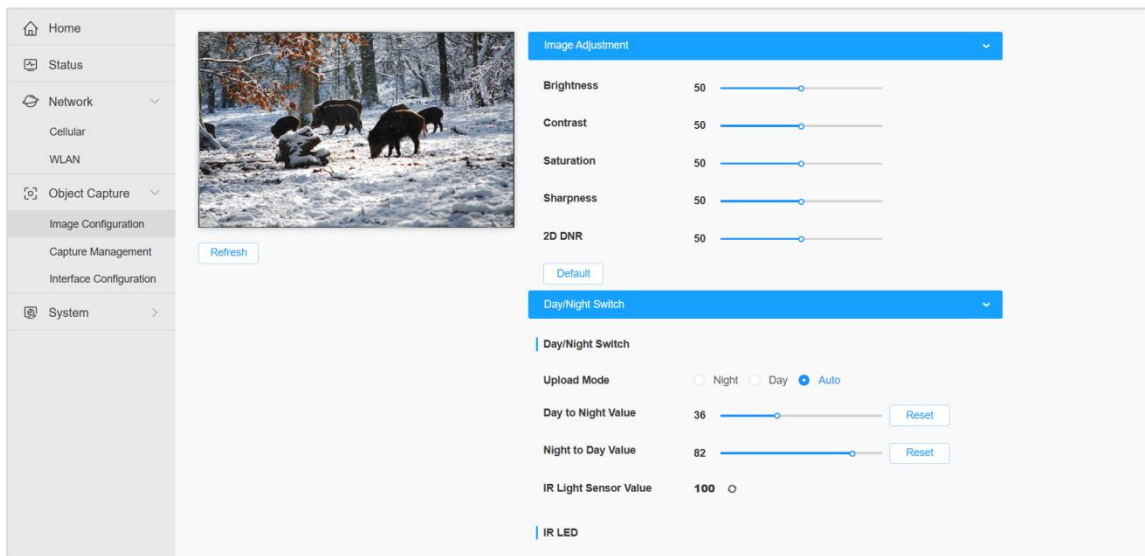

The configuration steps are as follows:

Step1: Configure Image Adjustment settings.

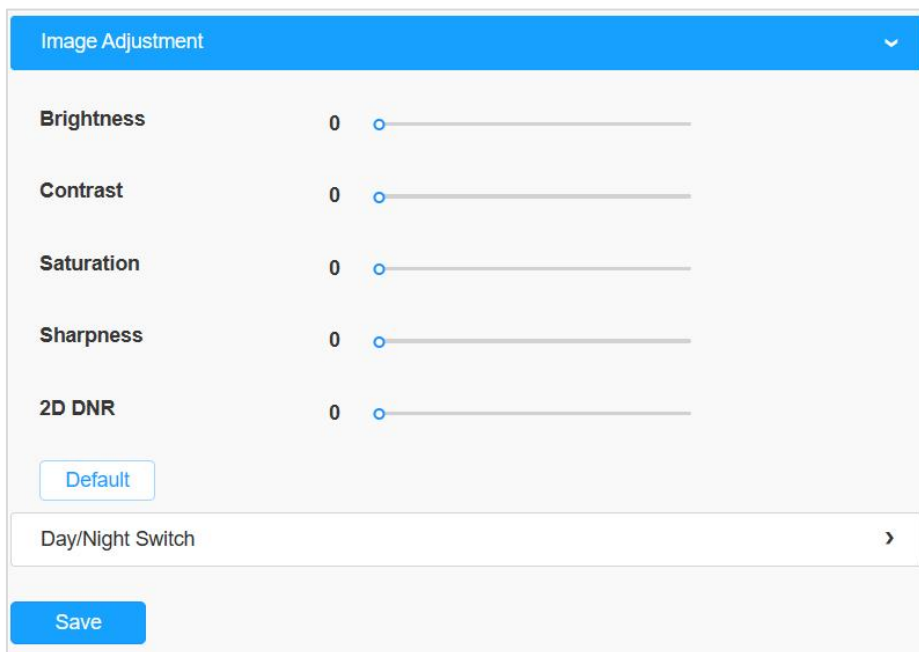

Please refer to the meaning of the options as follows:

Table 6. Description of the buttons

Parameters	Function Introduction
------------	-----------------------

Brightness	Adjust the Brightness of the scene.
Contrast	Adjust the color and light contrast.
Saturation	Adjust the Saturation of the image. Higher Saturation makes colors appear more "pure" while lower one appears more "wash-out".
Sharpness	Adjust the Sharpness of image. Higher Sharpness sharps the pixel boundary and makes the image looks "more clear".
2D DNR	Adjust the noise reduction level.
Default	Click this button to restore to the default settings.

Step2: Configure Day/Night Switch settings.

Day/Night Switch
▼

Day/Night Switch

Upload Mode Night Day Auto

Day to Night Value 1 [Reset](#)

Night to Day Value 1 [Reset](#)

IR Light Sensor Value -

IR LED

IR LED level 0 [Reset](#)

[Save](#)

Please refer to the meaning of the options as follows:

Table 7. Description of the buttons

Parameters	Function Introduction
Day/Night Mode	<p>Night Mode: Shown in live view based on Night Mode settings.</p> <p>Day Mode: Shown in live view based on Day Mode settings.</p> <p>Auto Mode: Shown in live view based on environment, set the sensitivity for switching Day Mode to Night Mode, or Night Mode to Day Mode.</p>
Day/Night Switch	<p>Day to Night Value: You can set the sensitivity for switching Day Mode to Night Mode. When IR Light Sensor Current Value is lower than this value, it will switch Day Mode to Night Mode. You can click Reset to reset the value to 36.</p> <p>Night to Day Value: This is the sensitivity for switching Night Mode to Day Mode.</p>

	<p>When IR Light Sensor Current Value is higher than this value, it will switch Night Mode to Day Mode. You can click Reset to reset the value to 82.</p> <p>IR Light Sensor Value: The current value of the IR light sensor.</p> <p>Note: The three buttons are optional only if you select Auto Mode.</p>
IR LED Level	<p>You can also manually adjust the strength of the IR LED, the range is from 0 to 100. The default value is 100, click the Reset button to return to the default value.</p>

Step3: After completing the above settings, click [Refresh](#) button to refresh the image.

7.2 Capture Management

Capture Management is used to configure Capture Settings and Upload Settings, such as Detection Mode, Upload Mode, Frequency, Sensitivity, etc., with the purpose of capturing and uploading the snapshots more accurately.

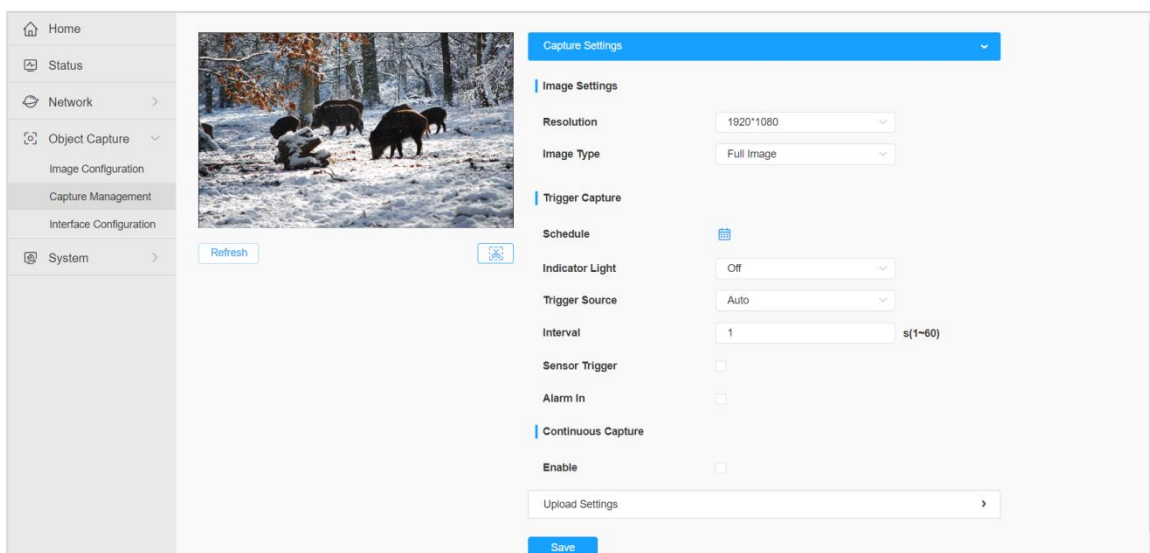

The configuration steps are as follow

Step1: Set the configuration of the captured images.

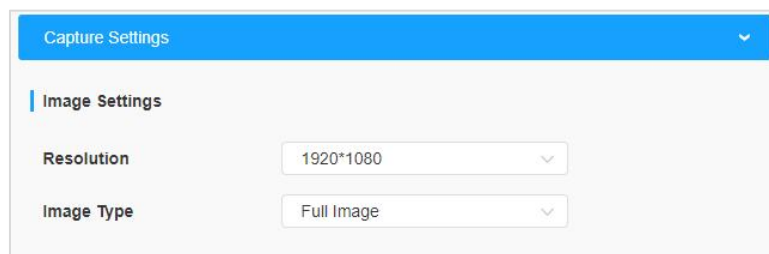

Please refer to the meaning of the options as follows:

Table 8. Description of the buttons

Parameters	Function Introduction
------------	-----------------------

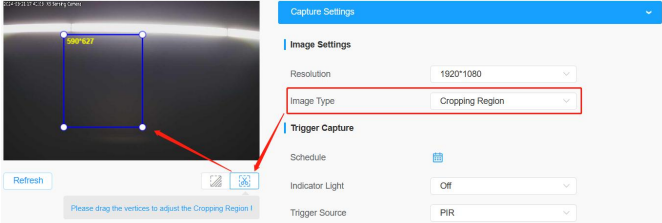
Resolution	Select the resolution of the captured images, including 1920*1080, 1280*960, 1280*720 and 704*576. The default option is 1920*1080.
Image Type	<p>Select the captured image type, including Full Image and Cropping Region. The default option is Full Image.</p> <p>Full Image: It will capture the full image when an object is detected.</p> <p>Cropping Region: The captured image will be cropped according to your settings when an object is detected.</p> <p>Note: If you have selected the image type as Cropping Region, please click  button to draw the corresponding cropping region, it will show a blue frame with pixels on the screen.</p> 

Step2: Set capture configuration. There are two capture types available, including Trigger Capture and Continuous Capture.

- ✧ **Trigger Capture:** Only when the device detects an object will it trigger the capture of the image.
- ✧ **Continuous Capture:** It will capture the images continuously according to the interval you set, whether or not objects are detected.

Trigger Capture

Schedule 

Indicator Light

Trigger Source

Interval s(1~60)

Sensor Trigger

Alarm In

Continuous Capture

Enable

Interval

For more details about the options, please refer to the table below:

Table 9. Description of the button

Parameters		Function Introduction
Trigger Capture	Schedule	Set the capture schedule, the range is 00:00 ~ 23:59.

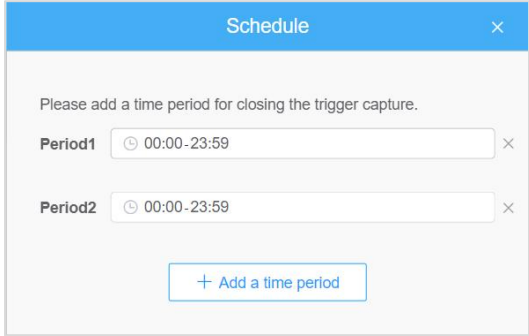
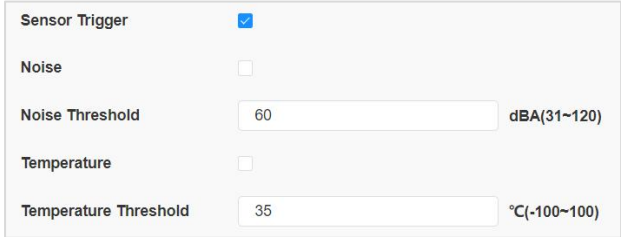
		
	Indicator Light	<p>Set the status of the indicator light to On or Off.</p> <p>On: Turn on the indicator light. When the capture is triggered, the indicator light on the front of the device will light up green.</p> <p>Off: Turn off the indicator light. When the capture is triggered, the indicator light will not light up.</p>
	Trigger Source	Set the trigger source of the device, including Auto, PIR and Radar.
	Interval	Set the capture trigger interval. Valid range is 1s~60s.
	Sensor Trigger	<p>Set the sensor trigger of noise or temperature.</p> <p>Noise range: 31~120 dBA</p> <p>Temperature range: -100~100 °C</p> 
	Alarm In	<p>Enable the external alarm (DI) to trigger the capture. The capture will be trigger when it receives a low level signal from alarm-in interface.</p> <p>High Level: Two wire are not short</p> <p>Low Level: Two wire short connection</p>
Continuous Capture	Enable	Check the checkbox to enable Continuous Capture.
	Interval	Set the capture interval, input the number and select the unit as minute or hour.

Step3: Set Upload Settings. This device allows you to transmit the snapshot remotely via MQTT/MQTT(s)/HTTP protocols to any third party's system. And there are two upload mechanisms available, including Timing and Immediacy.

For more details about the options, please refer to the table below:

Upload Settings
▼

Snapshots Upload Settings

Upload Mode ⓘ Timing Immediacy

Frequency Once a Day ▼

Time 🕒 21:15

Data Post

Enable Post

AIoT Sensing Platform Mode

Post Content Snapshot Status Alarm

Snapshot Topic X5SensingCam/Snapshot

Status Topic X5SensingCam/Status

Alarm Topic X5SensingCam/Alarm

Configure Request Topic X5SensingCam/ConfigureReques

Configure Respond Topic X5SensingCam/ConfigureRespor

Post Type MQTT ▼

Table 10. Description of the buttons

Parameters		Function Introduction
Snapshots Upload Settings	Timing	<p>In this mode, it will upload the captured images at the interval you set. Frequency: Set the upload frequency to Once a Day or Twice a Day. Time: Set the time to upload the snapshots every day according to the set frequency.</p> <p>Note:</p> <ol style="list-style-type: none"> The timing mode can work normally only when the SD card is inserted. You can check this option to delete the snapshots after uploading.
	Immediacy	In this mode, the captured images will only be uploaded when the device detects an object and triggers the capture.
Data Post	Enable Post	Check the checkbox to enable snapshot uploading.
	AIoT Sensing Platform Mode	Click to uploading the snapshot and information to Milesight AIoT Sensing Platform.
	Post Content	Select post content, including Snapshot, Status and Alarm. The Snapshot Topic and Status Topic can be customized.
	Configure Request Topic	You can customize the Configure Request Topic.

	Configure Respond Topic	You can customize the Configure Respond Topic.
	MQTT	Host: MQTT broker address to receive data. Post: MQTT broker port to receive data. User Name: The username used for connecting to the MQTT broker. Password: The password used for connecting to the MQTT broker.
	HTTP	URL: The URL of HTTP. User Name: The username used for connecting to the HTTP. Password: The password used for connecting to the HTTP.

7.3 Interface Configuration

Interface Configuration is used to view the current status of external input and external output and configure the threshold of noise and temperature.

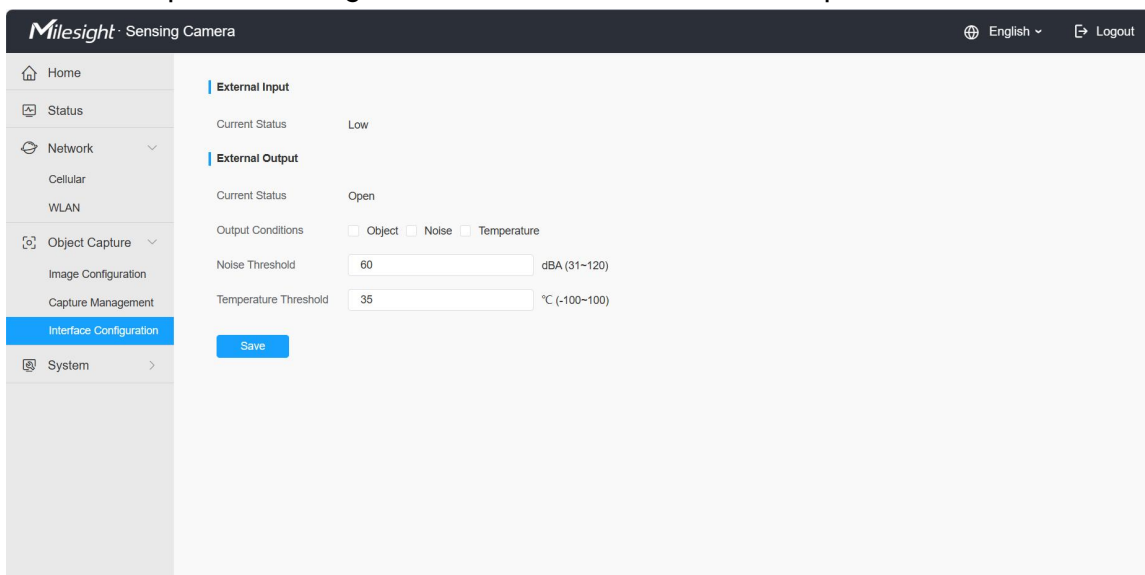

For more details about the options, please refer to the table below:

Table 11. Description of the buttons

Parameters		Function Introduction
External Input	Current Status	Current status of the external input interface.
External Output	Current Status	Current status of the external output interface.
	Output Conditions	Set the output conditions, including Object, Noise and Temperature.
	Noise Threshold	Set the sensor trigger of noise. Noise range: 31~120 dBA

	Temperature Threshold	Set the sensor trigger of temperature. Temperature range: -100~100 °C
--	------------------------------	--

Chapter 8. System

8.1 System info

All information about the hardware and software of the camera can be checked on this page.

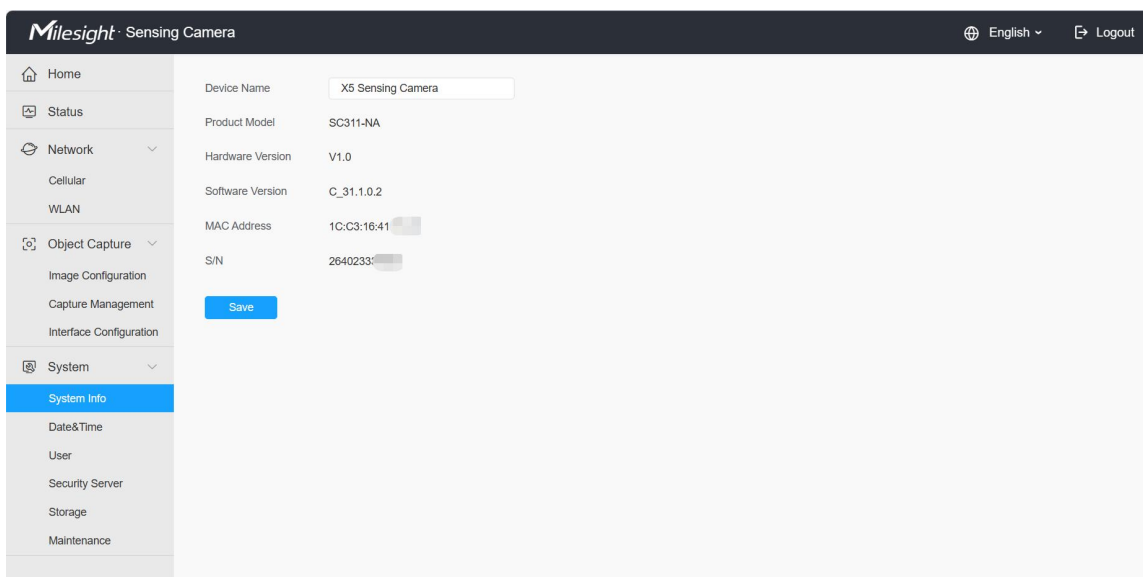

For more details about the options, please refer to the table below:

Table 12. Description of the buttons

Parameters	Function Introduction
Device Name	The device name can be customized.
Product Model	The product model of the camera.
Hardware Version	The hardware version of the camera.
Software Version	The software version of the camera can be upgraded.
MAC Address	Media Access Control address.
S/N	Stock Number.

Save

Save the configuration.

8.2 Date&Time

All information about the hardware and software of the camera can be checked on this page.

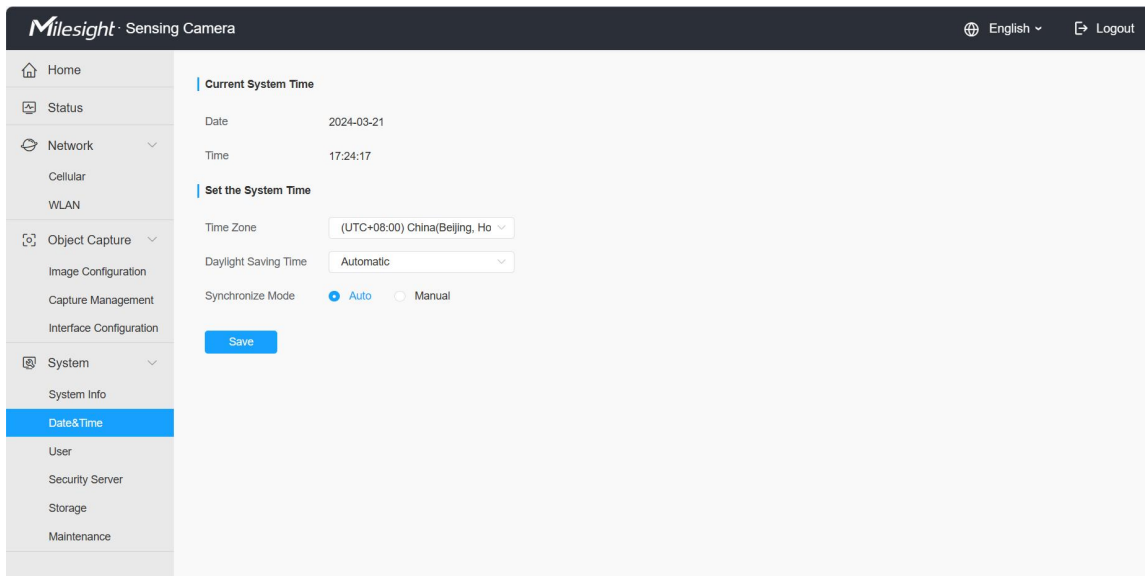

For more details about the options, please refer to the table below:

Table 13. Description of the buttons

Parameters	Function Introduction
Current System Time	Current date&time of the system.
Set the System Time	Time Zone: Choose a time zone for your location.
Set the System Time	Daylight Saving time: Enable the daylight saving time.
	Synchronize Mode: Auto and Manual options are available. Auto: Synchronize the time with NTP server first, if failed, synchronize the time with GPS.
Save	Save the configuration.

8.3 User

You can change the user password in this interface for security.

- Default User Name: admin
- Default Password: ms123456

Please refer to the meaning of the options as follows:

Table 14. Description of the buttons.

Item	Description
Admin Password	Input the current admin password.
User Name	Display the user name of the device.
New Password	Input a new password for the account.
Confirm	Confirm the new password.

8.4 Security Service

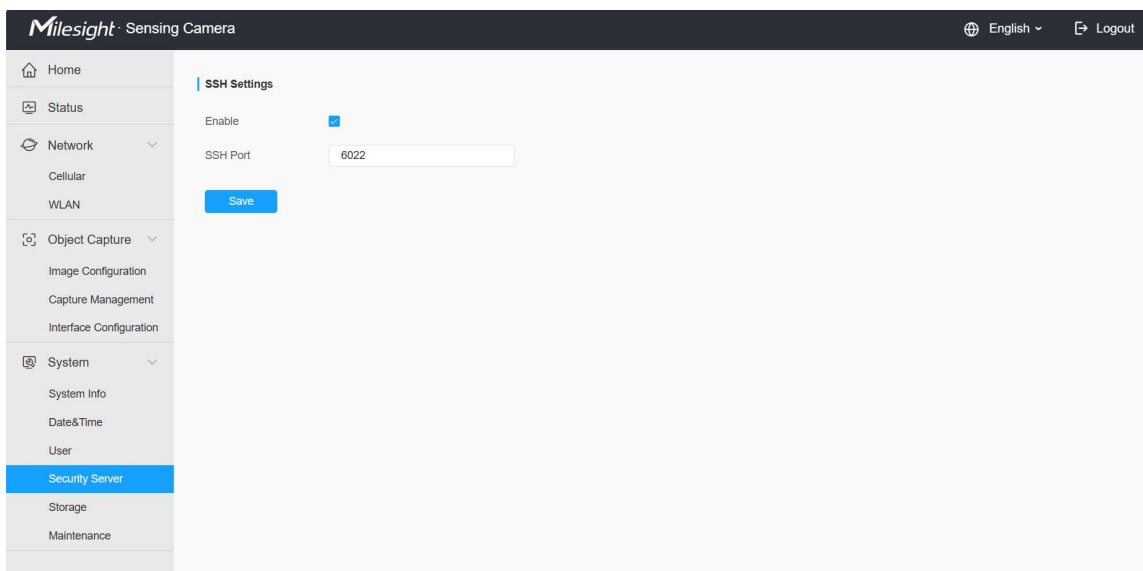
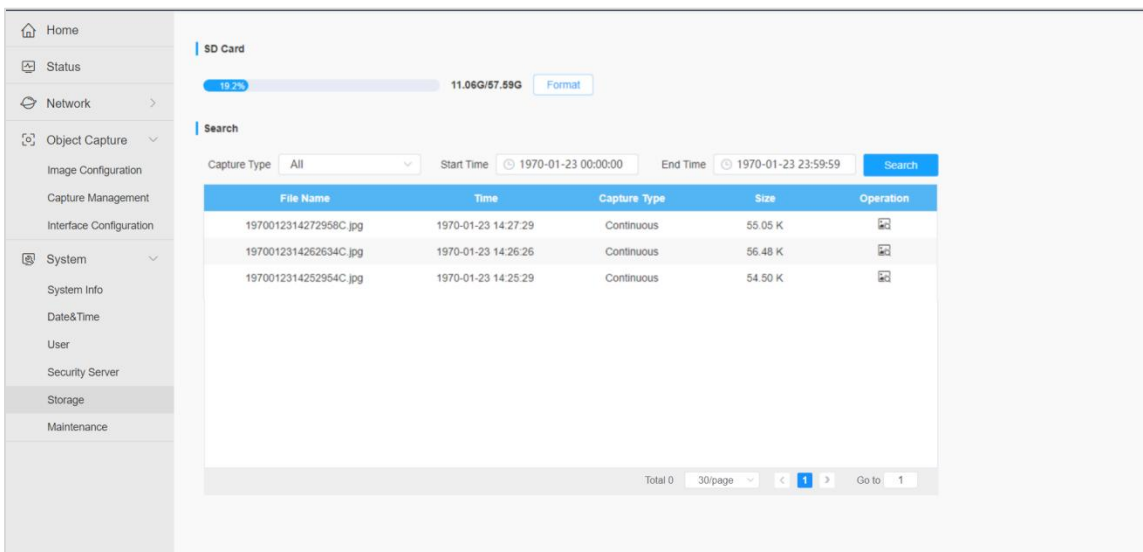

Table 15. Description of the buttons

Parameters	Function Introduction
SSH Settings	Secure Shell (SSH) has many functions: it can replace Telnet and also provides a secure channel for FTP, POP, even for PPP.



8.5 Storage

If an SD card is inserted into the device, the snapshots can be saved to the SD card. Here you can check the status of the SD card, search and manage snapshots in the SD card.



Please refer to the meaning of the options as follows:

Table 16. Description of the buttons

Item	Description
SD Card	Format: Format the SD card, the files in the SD card will be removed. Mount/UnMount: Mount/Dismount SD card.
Search	Select Capture Type and Start/End time, then click the search button to search out snapshots.
	Click this button to display the entire snapshot as shown below: 

8.6 System Maintenance

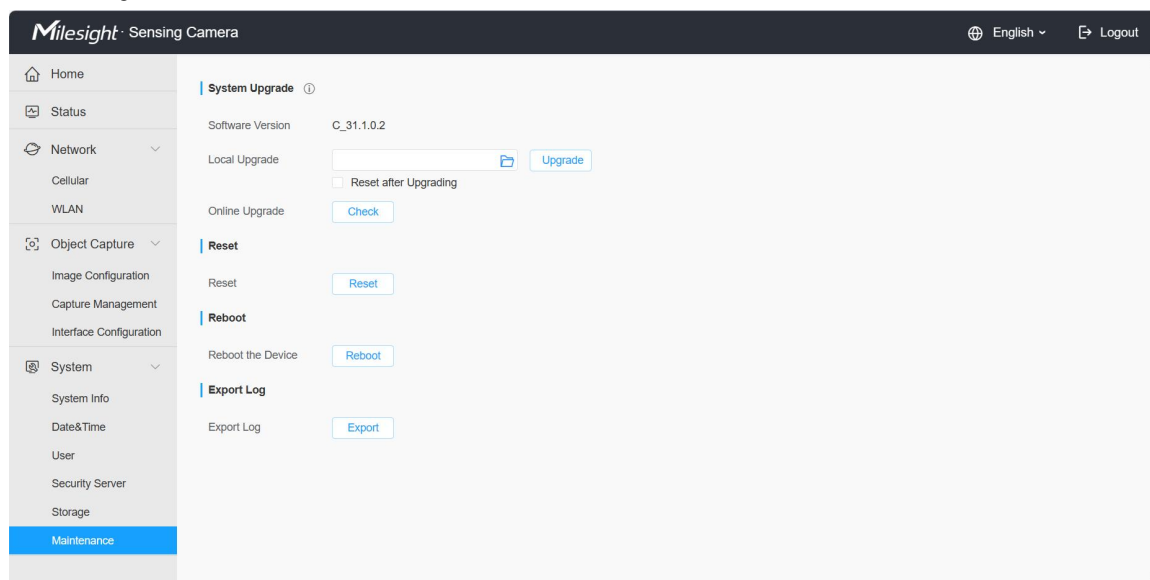

Table 17. Description of the buttons

Parameters	Function Introduction
System Upgrade	<p>Software Version: The software version of the camera.</p> <p>Local Upgrade: Click the "Browse" button and select the upgrading file, then click the "Upgrade" button to upgrade. After the system reboots successfully, the update is done.</p> <p>You can check "Reset after Upgrading" to reset the camera after upgrading it.</p> <p>Online Upgrade: Click the "Check" button to check the current latest firmware version on our website, and then click "OK" to upgrade to this version.</p> <p>It will prompt "The current version is the latest version" if your camera is already</p>

	the latest version. Note: Do not disconnect the power of the device during the update. The device will be restarted to complete the upgrading.
Reset	Click "Reset" button to reset the camera to factory default settings.
Reboot	Click "Reboot" button to restart the device immediately.
Export Log	Click "Export" button to export logs and system information of the device operation status. Note: The file format is ".csv" .

Chapter 9. Communication Protocol

SC311 will send device information and screenshot data in json format to MQTT broker.

```
{
  "ts": 1689065610613, //capture timestamp, unit: ms
  "values":
  {
    "devName": "X5 Sensing Camera",
    "devMac": "1C:C3:16:43:01:62",
    "battery": 100,
    "snapType": "Button", //capture type: Button, Timer, Alarm in
    "localtime": "2023-08-21 16:53:30", //upload time
    "imageSize": 62163,
    "image": "data:image/jpeg;base64,/9j/4AAQSkZJRgABAQA...(Image code)"
  }
}
```

—END—