



# Mini AI Thermopile People Counter

Featuring LoRaWAN®

VS351



## Safety Precautions

Milesight will not shoulder responsibility for any loss or damage resulting from not following the instructions of this operating guide.

- ❖ The device must not be disassembled or remodeled in any way.
- ❖ The device is not intended to be used as a reference sensor, and Milesight will not hold responsibility for any damage which may result from inaccurate readings.
- ❖ Do not place the device in places where the temperature is below/above the operating range.
- ❖ Do not place the device near naked flames, heat source (such as oven), or expose it to sunlight, cold source, liquid, and with extreme temperature changes.
- ❖ Remove the battery from the device if it is not to be used for an extended period. Otherwise, the battery might leak and damage the device.
- ❖ The device must never be subjected to shocks or impacts.

## Declaration of Conformity

VS351 is in conformity with the essential requirements and other relevant provisions of the CE, FCC, and RoHS.

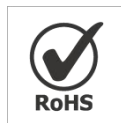

## Copyright © 2011-2024 Milesight. All rights reserved.

All information in this guide is protected by copyright law. Whereby, no organization or individual shall copy or reproduce the whole or part of this user guide by any means without written authorization from Xiamen Milesight IoT Co., Ltd.

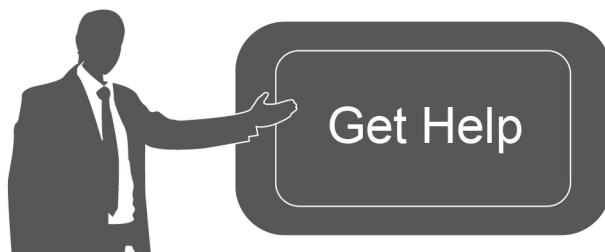

For assistance, please contact

Milesight technical support:

Email: [iot.support@milesight.com](mailto:iot.support@milesight.com)

Support Portal: [support.milesight-iot.com](http://support.milesight-iot.com)

Tel: 86-592-5085280

Fax: 86-592-5023065

Address: Building C09, Software Park  
Phase III, Xiamen 361024,  
China

**Revision History**

Date	Doc Version	Description
Jul. 5, 2024	V1.0	Initial version

# Contents

1. Product Introduction .....	5
1.1 Overview .....	5
1.2 Key Features .....	5
2. Hardware Introduction .....	6
2.1 Packing List .....	6
2.2 Hardware Overview .....	6
2.3 Dimensions (mm) .....	7
3. Power Supply .....	7
4. Operation Guide .....	8
4.1 NFC Configuration .....	8
4.2 LoRaWAN® Settings .....	9
4.3 General Settings .....	11
4.4 Advanced Settings .....	13
4.4.1 Calibration Settings .....	13
4.4.2 Threshold Settings .....	13
4.4.3 Data Storage .....	14
4.4.4 Data Retransmission .....	15
4.4.5 Milesight D2D Settings .....	16
4.5 Maintenance .....	18
4.5.1 Backup .....	18
4.5.2 Upgrade .....	19
4.5.3 Reset to Factory Default .....	19
5. Installation Instruction .....	20
5.1 Installation .....	20
5.2 Factors Affecting Accuracy .....	23
6. Communication Protocol .....	24
6.1 Basic Information .....	24
6.2 Sensor Data .....	25
6.3 Downlink Commands .....	26
6.4 Historical Data Enquiry .....	30

# 1. Product Introduction

## 1.1 Overview

VS351 is a compact AI thermopile people counter designed for indoor entrances and exits applications, it offers high accuracy in bi-directional people counting, enabling effective analysis of foot traffic and efficient space management. Combined with a radar sensor for presence detection, it intelligently schedules the activation time of the thermopile to optimize power consumption. As a Milesight D2D controller, the VS351 seamlessly communicates with other Milesight D2D devices, establishing more possible connections and paving the way for smoother operations.

With easy configuration and wireless detection, the VS351 facilitates simple deployment and connectivity. Compliant with the Milesight LoRaWAN® gateway and Milesight IoT Cloud solution, users can know the number of people in any indoor space and trigger other sensors or appliances easily via a webpage or mobile App remotely.

## 1.2 Key Features

- Provide up to 95% detection accuracy (99% accuracy for single person passing) for bi-directional people counting with radar (Battery Version Only) and the thermopile technology
- Built-in temperature sensor that can not only support environmental temperature detection but also monitor whether the operating temperature of the device is within a reasonable range
- 100% anonymity and GDPR-compliant without image capturing, free from privacy concerns
- Type-C version (wired) and battery version (wireless) optional for different installation environments
- Ultra-low power consumption with up to 1.6-year battery life, complies with ESG low-carbon standards
- Wireless connectivity and convenient size improve the accessibility and simplicity of deployment
- Store locally 1,000 historical records and support retransmission to prevent data loss
- Support Milesight D2D protocol to enable ultra-low latency and direct control without gateways
- Equipped with NFC for one touch configuration
- Function well with standard LoRaWAN® gateways and network servers
- Compatible with Milesight IoT Cloud and Milesight Development Platform

## 2. Hardware Introduction

### 2.1 Packing List



1 × VS351 Sensor



1 × Mounting Plate

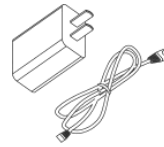

1 × Type-C Cable &  
Power Adapter  
(Type-C Version Only)

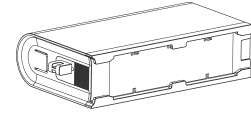

1 × Battery  
Compartment  
(Battery Version Only)

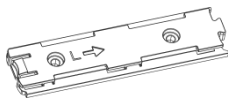

1 ×  
Battery Compartment  
Mounting Plate  
(Battery Version Only)

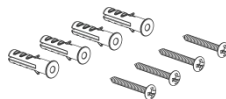

4 × Wall  
Screw Mounting Kits



1 ×  
Quick Start Guide



1 ×  
Warranty Card

**!** If any of the above items are missing or damaged, please contact your sales representative.

### 2.2 Hardware Overview

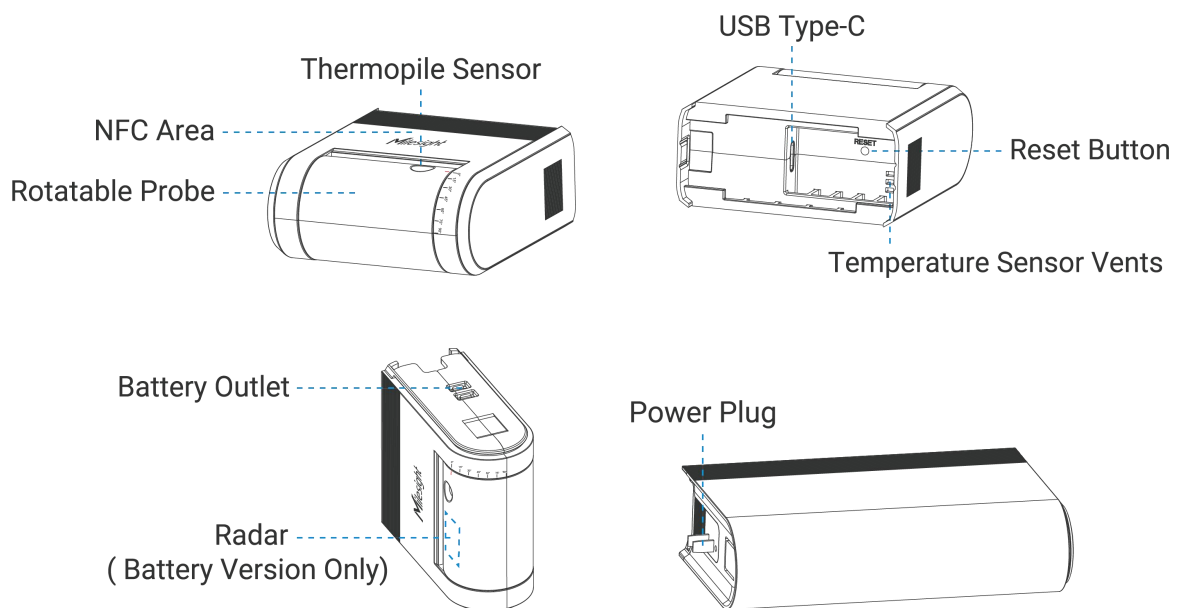

## 2.3 Dimensions (mm)

### Type-C Version:

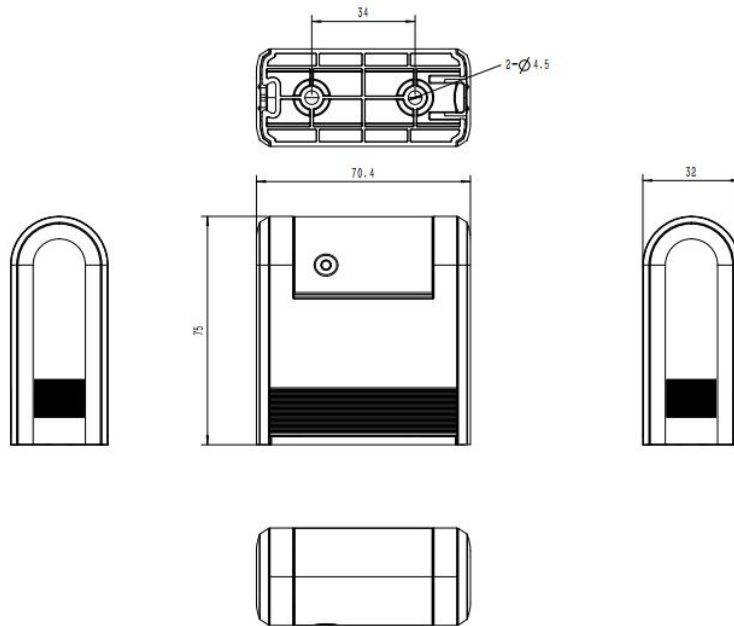

### Battery Version :

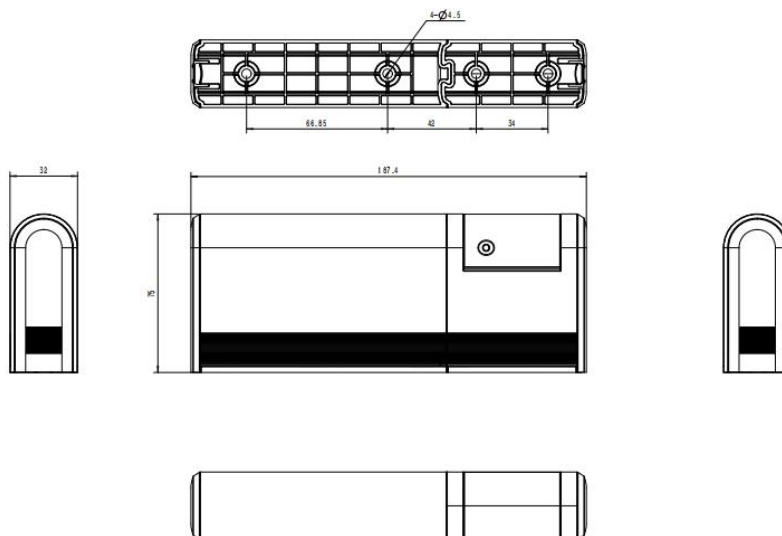

## 3. Power Supply

### Type-C Version:

Connect power cable to type-C port of device.

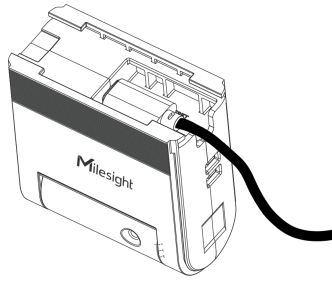

### Battery Version:

The batteries are installed in the battery compartment by default, please connect the power plug of battery compartment to battery outlet of device to power on it.

If the batteries are necessary to replace, remove the battery compartment from device and open the cover of the battery compartment as shown to insert to batteries.

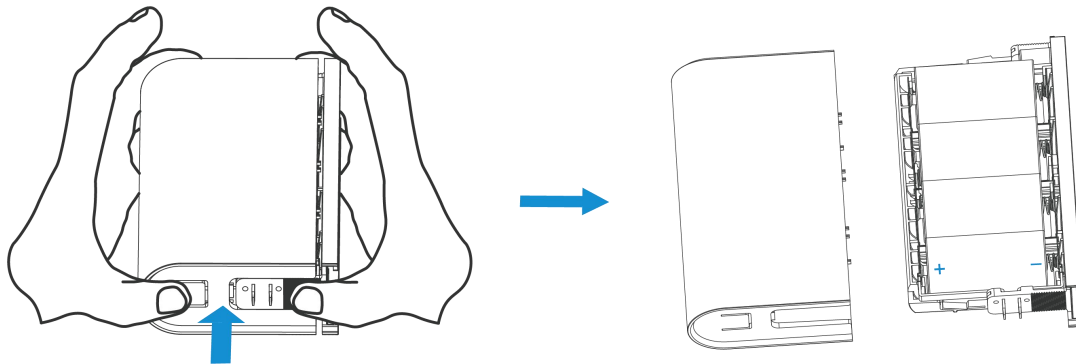

#### Note:

- 1) Ensure the plugs of battery compartment are not touched together in avoid to cause short circuit.
- 2) The device can only be powered by ER26500 Li-SOCl<sub>2</sub> batteries, not alkaline batteries.
- 3) Ensure all replaced batteries are the newest, otherwise the battery life will be shortened.

## 4. Operation Guide

### 4.1 NFC Configuration

1. Download and install "Milesight ToolBox App" on an NFC-supported smartphone.
2. Open "Milesight ToolBox App" and attach the NFC area of smartphone to the device. Click "NFC Read" to read the device and click "Write" to configure the device settings. It's suggested to change the default password for security reasons. (Default password: 123456)

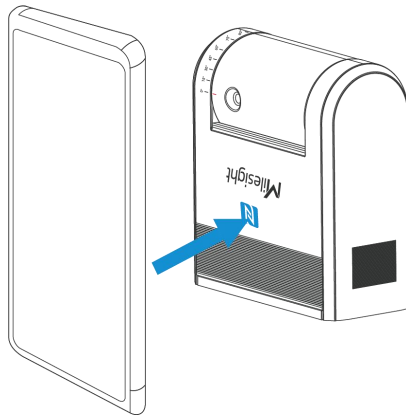

**Note:**

- 1) Ensure the location of the smartphone NFC area and it is recommended to take off the phone case.
- 2) If the smartphone fails to read/write configurations via NFC, move it away and try again later.

## 4.2 LoRaWAN® Settings

Go to **Device > Settings > LoRaWAN® Settings** of ToolBox App to configure AppEUI, Join Type, Application Key, and other information. You can also keep all settings by default.

Device EUI

24E124791D196040

\* APP EUI

24e124c0002a0001

\* Application Port  85

Join Type

ABP ▼





\* Network Session Key

\*\*\*\*\*

\* Application Session Key

\*\*\*\*\*

Parameters	Description
Device EUI	Unique ID of the device which can also be found on the label.
App EUI	The default App EUI is 24E124C0002A0001.
Application Port	The port is used for sending and receiving data, the default port is 85.
Join Type	OTAA and ABP modes are available.

Application Key	Appkey for OTAA mode, the default is 5572404C696E6B4C6F52613230313823.														
Network Session Key	Nwkskey for ABP mode, the default is 5572404C696E6B4C6F52613230313823.														
Application Session Key	Appskey for ABP mode, the default is 5572404C696E6B4C6F52613230313823.														
Device Address	DevAddr for ABP mode, the default is the 5th to 12th digits of the SN.														
LoRaWAN® Version	V1.0.2 and V1.0.3 are available.														
Work Mode	It's fixed as Class A.														
RX2 Data Rate	RX2 data rate to receive downlinks.														
RX2 Frequency	RX2 frequency to receive downlinks. Unit: Hz														
Channel Mode	Select Standard-Channel mode or Single-Channel mode. When Single-Channel mode is enabled, only one channel can be selected to send uplinks.														
Supported Frequency	<p>Enable or disable the frequency to send uplinks.</p> <p><b>Examples:</b></p> <p>1, 40: Enabling Channel 1 and Channel 40</p> <p>1-40: Enabling Channel 1 to Channel 40</p> <p>1-40, 60: Enabling Channel 1 to Channel 40 and Channel 60</p> <p>All: Enabling all channels</p> <p>Null: Indicate that all channels are disabled</p> <p>Channel Mode</p> <p>Standard-Channel </p> <p>Enable Channel Index </p> <p>8-15</p> <table border="1"> <thead> <tr> <th>Index</th> <th>Frequency/MHz </th> </tr> </thead> <tbody> <tr> <td>0 - 15</td> <td>470.3 - 473.3</td> </tr> <tr> <td>16 - 31</td> <td>473.5 - 476.5</td> </tr> <tr> <td>32 - 47</td> <td>476.7 - 479.7</td> </tr> <tr> <td>48 - 63</td> <td>479.9 - 482.9</td> </tr> <tr> <td>64 - 79</td> <td>483.1 - 486.1</td> </tr> <tr> <td>80 - 95</td> <td>486.3 - 489.3</td> </tr> </tbody> </table>	Index	Frequency/MHz 	0 - 15	470.3 - 473.3	16 - 31	473.5 - 476.5	32 - 47	476.7 - 479.7	48 - 63	479.9 - 482.9	64 - 79	483.1 - 486.1	80 - 95	486.3 - 489.3
Index	Frequency/MHz 														
0 - 15	470.3 - 473.3														
16 - 31	473.5 - 476.5														
32 - 47	476.7 - 479.7														
48 - 63	479.9 - 482.9														
64 - 79	483.1 - 486.1														
80 - 95	486.3 - 489.3														

Confirmed Mode	If the device does not receive an ACK packet from the network server, it will resend data once.
Rejoin Mode	<p>Reporting interval <math>\leq</math> 35 mins: the device will send a specific number of LinkCheckReq MAC packets to the network server every reporting interval or every double reporting interval to validate connectivity; If there is no response, the device will re-join the network.</p> <p>Reporting interval <math>&gt;</math> 35 mins: the device will send a specific number of LinkCheckReq MAC packets to the network server every reporting interval to validate connectivity; If there is no response, the device will re-join the network.</p> <p><b>Note:</b> Only OTAA mode supports rejoin mode.</p>
Set the number of packets sent	<p>When the rejoin mode is enabled, set the number of LinkCheckReq packets to send.</p> <p><b>Note:</b> the actual sending number is <b>Set the number of packet sent + 1</b>.</p>
ADR Mode	Allow network server to adjust the data rate of the device.
Spread Factor	If ADR is disabled, the device will send data via this spread factor.
Tx Power	Transmit power of the device.

**Note:**

- 1) Please contact sales personnel for device EUI list if there are many units.
- 2) Please contact sales personnel if you need random App keys before purchase.
- 3) Select OTAA mode if you are using Milesight IoT cloud to manage devices.

### 4.3 General Settings

Reporting Interval(min)

Reset Accumulated Value

Reset Time  00:00 Everyday >

Data Storage 

Data Retransmission 

Report Accumulated Value

Report Temperature

Temperature Unit

Flip Detection Direction 

Installation Height/mm

Hibernate Mode

Change Password

Parameters	Description
Reporting Interval	The interval of reporting people counting data and battery level to network server. Default: 10 min, Range: 1 - 1440 min
Reset Accumulated Value	Enable or disable to reset accumulated in/out counting values.
Reset Time	The time to reset accumulated in/out counting values. <b>Note:</b> The cumulative value will be reported once before reset.
<a href="#">Data Storage</a>	Disable or enable data storage locally.
<a href="#">Data Retransmission</a>	Disable or enable data retransmission.
Report Accumulated Value	Disable or enable to report accumulated counting values in periodic packets.
Report Temperature	Disable or enable to report temperature in periodic packets, this option

	will not affect temperature threshold alarm packets.
Temperature Unit	Set the temperature unit displayed on the status page.
Flip Detection Direction	<p>Disable or enable to change the detect direction.</p> <p>Default direction of ceiling mount:      Default direction of lintel mount:</p> 
Installation Height/mm	<p>Set the current installation height.</p> <p>Default: 2700 mm.Range: 2300~3000mm.</p>
Hibernate Mode	Disable or enable Hibernate mode and configure the Hibernate Period. It will stop counting and reporting when hibernating.
Change Password	Change the password for ToolBox App to write this device.

## 4.4 Advanced Settings

### 4.4.1 Calibration Settings

VS351 supports numerical calibration of the temperature value. Go to **Device > Settings > Calibration Settings** of ToolBox App to set the calibration value, the device will add calibration value to the current value and report the final value.



### 4.4.2 Threshold Settings

Go to **Device > Settings > Threshold Settings** of ToolBox App to enable and configure the threshold settings. If the threshold is triggered, the device will report the threshold alarm packet instantly.

**Note:** The optimal operating temperature range from 15°C to 30°C. The device will also report alarm packet when temperature is above 30°C, even if the temperature threshold is disabled.

**Periodic People Count**

In >

Out >

**Cumulative People Count**

Accumulated In >

Accumulated Out >

**Temperature**

Over / °C

Below / °C

#### 4.4.3 Data Storage

VS351 supports storing 1000 data records locally and exporting data via ToolBox App. The device will record the data according to the reporting interval even if it is disconnected from the network.

1. Go to **Device > Status** of ToolBox App to sync the device time.

Device Time 2023-08-08 19:22

2. Go to **Device > Setting > General Settings** to enable the data storage feature.

Data Storage

3. Go to **Device > Maintenance** of ToolBox App, click **Export**, then select the data time range and click **Confirm** to export data. The maximum export data period on ToolBox App is 14 days.

Cancel Export Data Period Confirm

2023-08-01 19:44 To 2023-08-08 19:44

2021 6 17 42

2022 7 18 43

2023 8 1 19 44

2 20 45

3 21 46

4. Click **Export Record** to find the export file records.



**Note:** Swipe the file record to the left to delete .

5. Click **Data Cleaning** to clear all stored data inside the device if necessary.

Export Historical Data



#### 4.4.4 Data Retransmission

VS351 supports data retransmission to ensure the network server can receive all data even if the network is down for some time. There are two ways to receive the lost data:

- Network server sends downlink commands to enquire the historical data for a specified time range, refer to section [Historical Data Enquiry](#);
- When network is down and receive no response from LinkCheckReq MAC packets for a period of time, the device will record the time of disconnection and retransmit the lost data after the device is reconnected to the network.

Here are the steps of data retransmission:

1. Go to **Device > Status** of ToolBox App to sync the device time.

Device Time 2023-08-08 19:22 Sync

2. Go to **Device > Setting > General Settings** to enable data storage feature and data retransmission feature.



3. Go to **Device > Setting > LoRaWAN Settings** to enable rejoin mode feature and set the number of packets sent. Take below as an example, the device will send LinkCheckReq MAC packets to the network server regularly to check for any network disconnection; if there is no response for 8+1 times, the join status will change to de-active and the device will record a data lost time point (the time it reconnected to the network).



4. After reconnecting to the network, the device will send the lost data from the point of time when the data was lost according to the data re-transmission reporting interval.

**Note:**

- 1) If the device is rebooted or re-powered during the data retransmission process, the device will re-send interrupted retransmission data again after the device is reconnected back to the network.
- 2) If the network is disconnected again during data retransmission, the device will only send the latest disconnected data.
- 3) The retransmission data format starts with "20ce", please refer to section [Historical Data Enquiry](#).
- 4) Data retransmission will increase the uplinks and shorten the battery life.

#### 4.4.5 Milesight D2D Settings

Milesight D2D protocol is developed by Milesight and used for setting up transmission among Milesight devices without a gateway. When the Milesight D2D setting is enabled, VS351 can work as a Milesight D2D controller to send control commands to trigger Milesight D2D agent devices.

1. Configure RX2 data rate and RX2 frequency in LoRaWAN<sup>®</sup> settings, it is suggested to change the default value if there are many LoRaWAN<sup>®</sup> devices around.



2. Go to **Device > Settings > D2D Settings** to enable D2D function and configure the D2D settings.

Enable

D2D Key

Someone Entered

Control command

LoRa Uplink [i](#)

Control Time /min [i](#)

Someone Left

People Counting Threshold Triggered

Temperature Threshold Triggered

Temperature Threshold Released

Parameters	Description
Enable	Enable or disable Milesight D2D feature.
D2D Key	Define a unique D2D key which is the same as the setting in D2D agent devices. Default value: 5572404C696E6B4C6F52613230313823
Status Condition	<p>When VS351 detects one or more of the below statuses, it will send the control command to the corresponding Milesight D2D agent devices:</p> <ul style="list-style-type: none"> <li>● Someone entered</li> <li>● Someone Left</li> <li>● People Counting Threshold Triggered</li> <li>● Temperature threshold Triggered</li> <li>● Temperature threshold Released</li> </ul> <p><b>Note:</b> for people counting and temperature threshold conditions, please enable and configure the threshold feature under <b>Threshold Settings</b>.</p>
Control command	Define a 2-byte hexadecimal control command (0x0000 to 0xffff).
LoRa Uplink	If enabled, a LoRaWAN® uplink packet that contains the counting value or

	temperature alarm will be sent to gateway after the Milesight D2D control command is sent.
Control Time /min	After receiving commands from VS351, Milesight D2D agent devices will take corresponding actions within this duration. Default: 5 mins, Range: 1 - 1440 mins

## 4.5 Maintenance

### 4.5.1 Backup

VS351 supports backup templates for easy and quick device configurations in bulk. The backup feature is only for devices with the same model and LoRaWAN® frequency band.

1. Go to **Template** page on the App and save the current settings as a template. The saved templates are also editable.



2. Select one saved template and click **Write**, then attach the smartphone to another device via NFC to reuse the template.

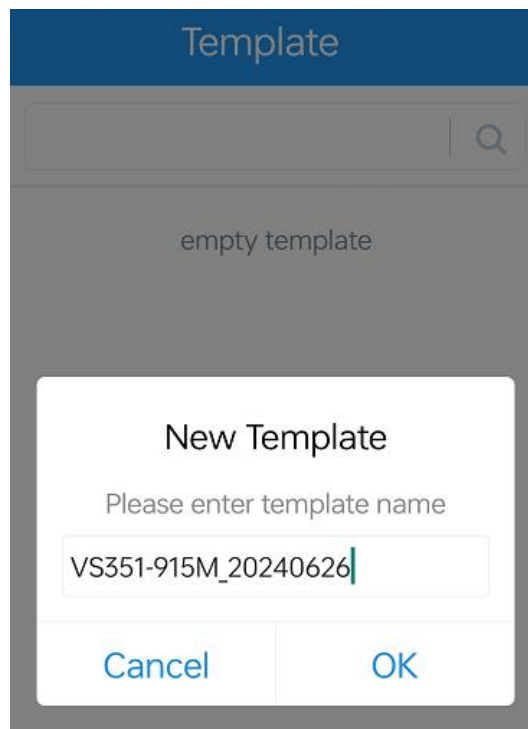

**Note:** Swipe the template item to the left to edit or delete the template. Click the template to edit the configurations.

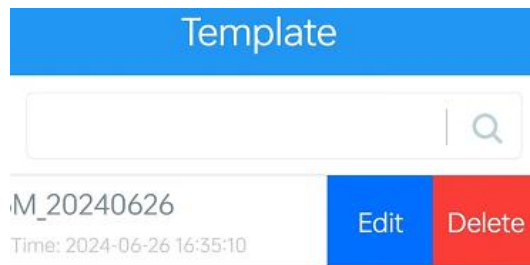

#### 4.5.2 Upgrade

1. Download firmware from the Milesight website to your smartphone.
2. Go to **Device > Maintenance** of ToolBox App, click **Browse** to import firmware and upgrade the device.



**Note:**

- 1) Operation on ToolBox is not supported during a firmware upgrade.
- 2) Only the Android version of ToolBox supports the upgrade feature.

#### 4.5.3 Reset to Factory Default

VS351 supports two methods to reset the device, which are as following:

**Via Hardware:** Press and hold the reset button for more than 10s .

**Via ToolBox App:** Go to **Device > Maintenance** to tap **Reset**, then attach the smartphone to the device via NFC to complete the reset.

Status	Setting	Maintenance
SN	6799E263371700 00	
Model	VS351-915M	
Firmware Version	V1.1	
Hardware Version	V1.1	
Manual Upgrade		
<input type="button" value="Browse"/>		
Restore Factory Default		
<input type="button" value="Reset"/>		

## 5. Installation Instruction

### 5.1 Installation

1. Remove the two decorated plates from the side of the device.

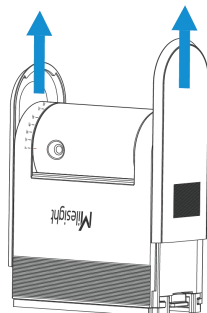

2. Fix the wall plugs to the ceiling or lintel with wall plugs, then fix the mounting plate with screws.

**Type-C Version:**

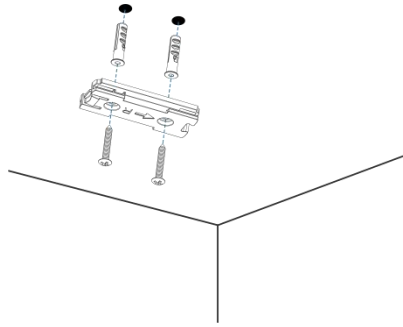

**Battery Version:** splice two mounting plates together before fix them.

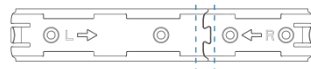

①

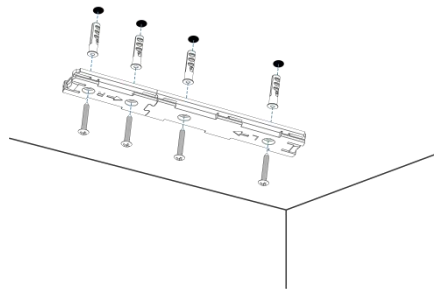

②

3. Adjust the probe and installation direction.

- Ceiling Mounted: rotate the probe and make sensors straight face to the ground.

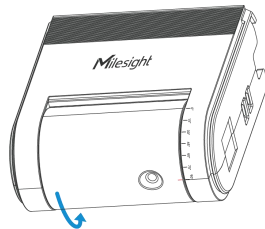

- Lintel Mounted: rotate the probe and make sensors straight face to the ground with the logo side.

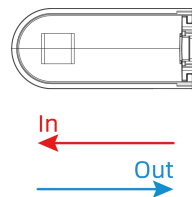
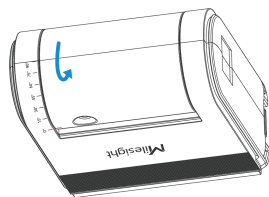

4. Connect power cable to type-C port of device (Type-C Version Only) .

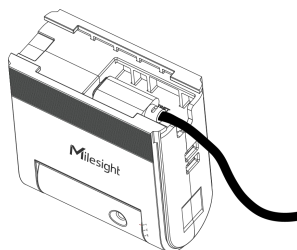

5. Fix the device and the battery compartment to the mounting plate.

**Type-C Version:** Align the slots of device to the grooves in the middle of the mounting plate, then slide the device to the mounting plate towards the direction indicated by the arrow on the plate.

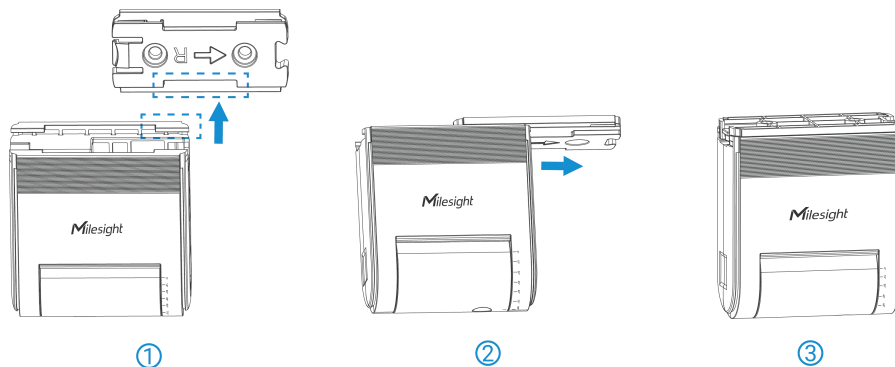

**Battery Version:** Align the slots of device to the grooves in the middle of the mounting plate, then slide the device and battery compartment to the mounting plate towards the direction indicated by the arrow on the plate.

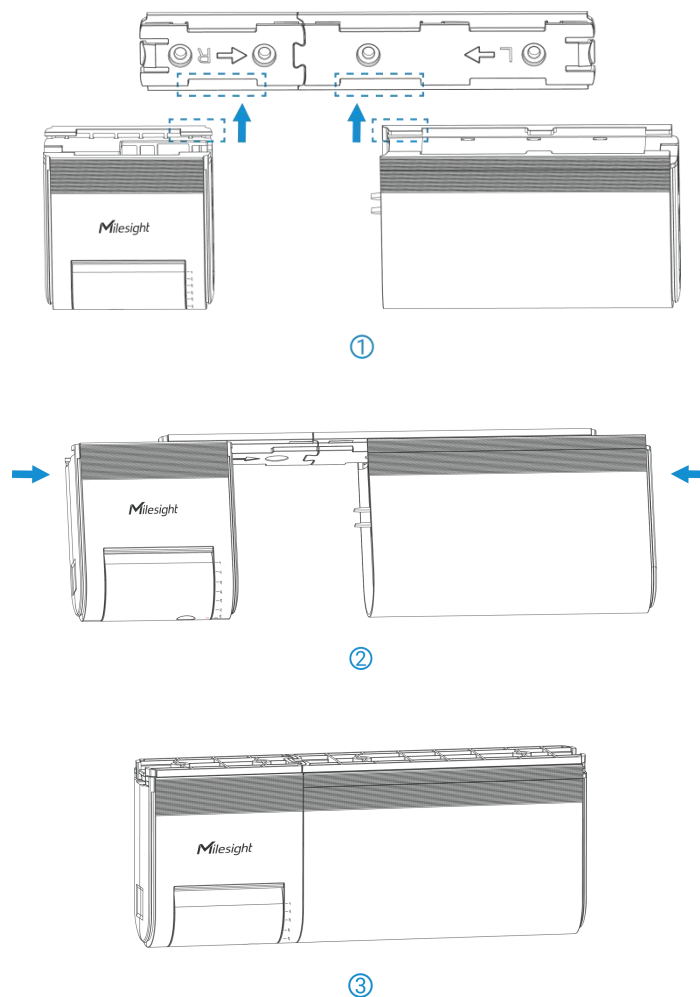

6. Slide the two decorated plates to the side of the device.

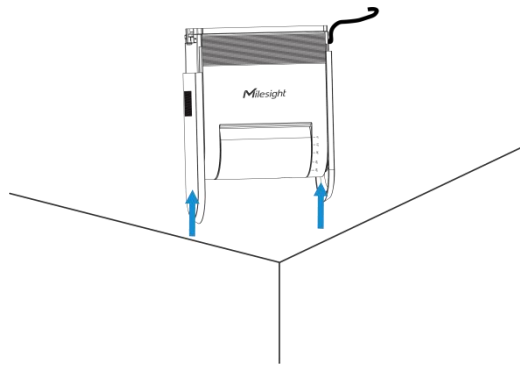
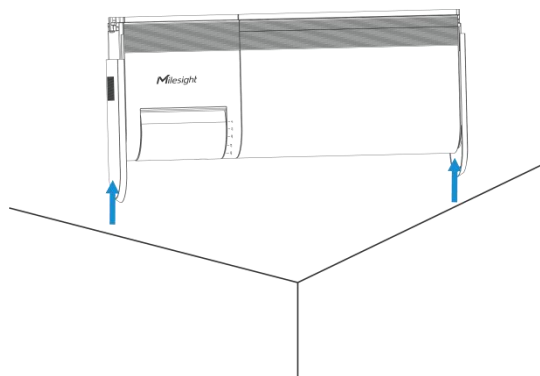
**Type-C Version:****Battery Version:****Installation Note:**

- The recommended installation height is 2.3~3m.
- Ensure the angle of sensor and ground is within 15°.

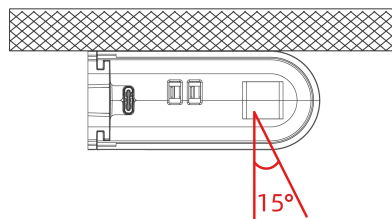

- The optimal operating temperature range is 15~30 °C, keep the device away from heat sources, cold sources, and the areas where airflow varies greatly, for example, windows, vents, fans, air conditioners, etc.
- Keep the device away from glass or mirror and out of children's reach.
- Ensure that there is no metal directly below the device, no other radar device within 30cm around, and no obstacle in the detection area.
- For battery version, please make sure there is no fixed and large moving objects (such as swing head fan) within the detection area of the device.

**5.2 Factors Affecting Accuracy**

- The people counting value will decrease in the following cases:
  - Close to the detection area edge or tilt through

- Walking in an extremely fast speed (more than 2 m/s)
- Two people walking side-by-side with a distance of less than 20cm
- A Person that is shorter than 1.5m
- The distance between the two people is less than 30~40cm
- When the installation height is 2.3m, if a target that is greater than 2m appears, it will be counted as 2 people.

## 6. Communication Protocol

All the data is based on the following format (HEX), the Data field should follow the little-endian:

Channel1	Type1	Data1	Channel2	Type2	Data2	Channel 3	...
1 Byte	1 Byte	N Bytes	1 Byte	1 Byte	M Bytes	1 Byte	...

For decoder examples please find files on <https://github.com/Milesight-IoT/SensorDecoders>.

### 6.1 Basic Information

VS351 sensor reports basic information whenever it joins the network.

Channel	Type	Byte	Description
ff	0b (Power On)	1	ff
	01(Protocol Version)	1	01=>V1
	16 (Device SN)	8	16 digits
	09 (Hardware Version)	2	01 00 => V1.0
	0a (Firmware Version)	2	01 14 => V1.14
	0f (Device Type)	1	00: Class A
	cc(Power Supply)	1	00: Battery supply, 01: Type-C supply

Example:

ff0bff ff0101 ff166791d19604050005 ff090100 ff0a0101 ff0f00 ffcc01					
Channel	Type	Value	Channel	Type	Value
ff	0b (Power On)	ff (Reserved)	ff	01 (Protocol Version)	01 (V1)
ff	16 (Device SN)	6791d19604050 005	ff	09 (Hardware Version)	0100 (V1.0)
ff	0a (Firmware Version)	0101 (V1.1)	ff	0f (Device Type)	00 (Class A)
Channel	Type	Value	Channel	Type	Value
ff	cc (Power	01 (Type-C supply)			



	Supply)				
--	---------	--	--	--	--

## 6.2 Sensor Data

Channel	Type	Byte	Description
01	75(Battery Level)	1	UINT8, Unit: %, [1-100]
03	67(Temperature)	2	INT16*0.1, Unit: °C
04	cc(Accumulated Counter)	4	<ul style="list-style-type: none"> <li>● Byte 1-2: Accumulated In Counter</li> <li>● Byte 3-4: Accumulated Out Counter</li> </ul>
05	cc(Periodic Counter)	4	<ul style="list-style-type: none"> <li>● Byte 1-2: In Counter during the report interval</li> <li>● Byte 3-4: Out Counter during the report interval</li> </ul>
83	67(Temperature Alarm)	3	<ul style="list-style-type: none"> <li>● Byte 1-2: Temperature</li> <li>● Byte 3: Alarm type</li> <li>00 - Threshold Alarm Release</li> <li>01 - Threshold Alarm</li> <li>03 - High Temperature Alarm: temp &gt; 30°C</li> <li>04 - High Temperature Alarm Release</li> </ul>
84	cc(Accumulated Counter Threshold Alarm)	5	<ul style="list-style-type: none"> <li>● Byte 1-2: Accumulated In Counter</li> <li>● Byte 3-4: Accumulated Out Counter</li> <li>● Byte 5: 01</li> </ul>
85	cc(Periodic Counter Threshold Alarm)	5	<ul style="list-style-type: none"> <li>● Byte 1-2: In Counter during the report interval</li> <li>● Byte 3-4: Out Counter during the report interval</li> <li>● Byte 5: 01</li> </ul>
20	ce(Historical Data)	9/13	<ul style="list-style-type: none"> <li>● Byte 1-4: Unix Timestamp</li> <li>● Byte 5: <ul style="list-style-type: none"> <li>00-Periodic Counter</li> <li>01-Periodic Counter + Accumulated Counter</li> </ul> </li> <li>● Byte 6-7: Periodic In Counter</li> <li>● Byte 8-9: Periodic Out Counter</li> <li>● Byte 10-11: Accumulated In Counter</li> <li>● Byte 12-13: Accumulated Out Counter</li> </ul>

**Examples:**

## 1. Periodic packet:

04cc 20001700 0367 1a01 05cc 01000000 017562					
Channel	Type	Value	Channel	Type	Value
04	cc(Accumulated Counter)	Accumulated In: 20 00=> 00 0c=32 Accumulated Out: 17 00=>00 17=23	03	67 (Temperature)	1a01 => 011a =>282*0.1 =28.2°C
Channel	Type	Value	Channel	Type	Value
05	cc(Periodic Counter)	In: 01 00=> 00 01=1 Out: 00 00=0	01	75 (Battery Level)	62=>98%

## 2. People Counter alarm packet: report when the counting value reaches the threshold.

84 cc 04000600 01		
Channel	Type	Value
84	cc(Accumulated Counter Alarm)	Accumulated in: 0400=>0004=4 Accumulated out: 0600=>0006=6 01= Threshold Alarm

## 3. Temperature alarm packet: report when the temperature reaches the threshold.

8367 0e01 01		
Channel	Type	Value
83	67(Temperature Threshold Alarm)	Temperature: 0e 01 =>01 0e = 270*0.1 = 27 °C 01= Threshold Alarm

**6.3 Downlink Commands**

VS351 supports downlink commands to configure the device. The application port is 85 by default.

Channel	Type	Byte	Description
ff	10(Reboot)	1	ff
	8e(Reporting Interval)	3	<ul style="list-style-type: none"> <li>Byte 1: 00</li> <li>Byte 2-3: Reporting Interval, INT16, Unit: min</li> </ul>
	a6(Reset Accumulated Value)	1	01: enable; 00: disable
	a8(Accumulated Counter Clearing)	1	01: clear accumulate In counter 02: clear accumulate Out counter

ed(Reset Accumulated Counter Time)	3	<ul style="list-style-type: none"> <li>● Byte 1: Reset date 00: Everyday; 01: Every Sunday; 02: Every Monday; 03: Every Tuesday ; 04: Every Wednesday; 05: Every Thursday; 06: Every Friday; 07: Every Saturday</li> <li>● Byte 2: Reset hour</li> <li>● Byte 3: Reset minute</li> </ul>
68(Data Storage)	1	01: enable; 00: disable
69(Data Retransmission)	1	01: enable; 00: disable
6a(Data Retransmission Interval)	3	<ul style="list-style-type: none"> <li>● Byte 1: 00</li> <li>● Byte 2-3: interval time, unit: s range: 30~1200s (600s by default)</li> </ul>
a9(Report Accumulated Value)	1	01: enable; 00: disable
aa(Report Temperature)	1	01: enable; 00: disable
ec(Flip Detection Direction)	1	01: enable, 00: disable
77(Installation Height)	2	Unit: mm
75(Hibernate Period)	6	<ul style="list-style-type: none"> <li>● Byte 1: 01-enable, 00-disable</li> <li>● Byte 2-3: Start Time, unit: min</li> <li>● Byte 4-5: End Time, unit: min</li> <li>● Byte 6: Set Hibernate Period, <ul style="list-style-type: none"> <li>➤ Bit0=1</li> <li>➤ Bit7~Bit1: Sunday~Monday</li> </ul> </li> </ul> <p><b>Note:</b> if start time equals end time, it means all day.</p>
ab(Temperature Calibration)	3	<ul style="list-style-type: none"> <li>● Byte 1: 01: enable; 00: disable</li> <li>● Byte 2-3: calibration value*0.1</li> </ul>
06(Threshold Alarm)	9	<ul style="list-style-type: none"> <li>● Byte 1: <ul style="list-style-type: none"> <li>➤ Bit0~Bit2: 000-disable 001-below (minimum threshold) 010-above (maximum threshold) 011-within</li> </ul> </li> </ul>

			100-below or above ➤ Bit3~Bit5: 001-Periodic Counter threshold 010-Accumulated Counter threshold 011-Temperature threshold ➤ Bit6~Bit7: 11 ● Byte 2-3: Min.value ● Byte 4-5: Max. value ● Byte 6-9: 00000000
	84(Milesight D2D Feature)	1	01: enable; 00: disable
	35(Milesight D2D Key)	8	First 16 digits, last 16 digits are fixed as 0
	96(Milesight D2D Settings)	8	● Byte 1: 01-Someone Entered 02-Someone Left 03-People Counting Threshold Triggered 04-Temperature threshold triggered 05-Temperature threshold released ● Byte 2: 01-enable, 00-disable ● Byte 3: 01-enable LoRa Uplink, 00-disable LoRa Uplink ● Byte 4-5: D2D control command ● Byte 6-7: control time, Unit: min ● Byte 8: 01-enable control time, 00-disable control time

**Examples:**

1. Reboot the device.

<b>ff10ff</b>		
Channel	Type	Value
ff	10 (Reboot)	ff

2. Set reporting interval as 2 minutes.

<b>ff8e 00 0200</b>		
Channel	Type	Value
ff	8e (Reporting Interval)	02 00=>00 02=>2 mins

3. Set Reset Accumulated Counter Time as Every Sunday 12: 20.

ffed 01 0c 14		
Channel	Type	Value
ff	ed (Reset Accumulated Counter Time)	01=>Every Sunday Reset hour: 0c => 12 Reset minute: 14=> 20

3. Enable temperature and set calibration value.

ffab 01 fdff		
Channel	Type	Value
ff	ab (Temperature Calibration)	01=Enable fdff=>fffd=-3*0.1=-0.3

4. Set D2D Key as 5572404C696E6B4C0000000000000000.

ff35 5572404C696E6B4C		
Channel	Type	Value
ff	35 (Set D2D Key)	5572404C696E6B4C

5. Set D2D settings.

ff96 03 01 01 04e0 0500 01		
Channel	Type	Value
ff	96 (D2D Settings)	03=> People counting threshold triggered; 01=>Enable; 01=>Enable LoRa Uplink; 04 e0=>e0 04, Control Command is e0 04; 05 00=>00 05, Control time is 5 mins; 01=>Enable Control Time

6. Set temperature threshold alarm.

ff06 dc 9600 2c01 00000000		
Channel	Type	Value
ff	06 (Threshold Alarm)	dc=>11 011 100=below or above Min_value: 96 00=>00 96=15°C Max_value: 2c 01=>01 2c=30°C

7. Set up Hibernate Mode.

ff75 01 e001 ec04 ff		
Channel	Type	Value
ff	75 (Hibernate Mode)	01: Enable Hibernate mode e0 01 => 01 e0 = 480 minutes = 8 hours = 8:00 ec 04 => 04 ec = 1260minutes =21 hours = 21:00 ff: Hibernate period is from Sunday to Monday

## 6.4 Historical Data Enquiry

VS351 supports sending downlink commands to enquire historical data for a specified time point or time range. Before that, ensure **the device time is correct and the data storage feature was enabled to store the data.**

### Command format:

Channel	Type	Byte	Description
fd	6b (Enquire data in time point)	4	Unix timestamp
	6c (Enquire data in time range)	8	<ul style="list-style-type: none"> <li>Byte 1-4: Start time, Unix timestamp</li> <li>Byte 5-8: End time, Unix timestamp</li> </ul>
	6d (Stop query data report)	1	ff
ff	6a (Report Interval)	3	<ul style="list-style-type: none"> <li>Byte 1: 01</li> <li>Byte 2: Interval time, unit: s, range: 30~1200s (60s by default)</li> </ul>

### Reply format:

Channel	Type	Byte	Description
fc	6b/6c	1	00: data enquiry success 01: time point or time range invalid 02: no data in this time or time range
20	ce (Historical Data)	9/13	<ul style="list-style-type: none"> <li>Byte 1-4: Unix Timestamp</li> <li>Byte 5:               <ul style="list-style-type: none"> <li>00-Periodic Counter</li> <li>01-Periodic Counter + Accumulated Counter</li> </ul> </li> <li>Byte 6-7: Periodic In Counter</li> <li>Byte 8-9: Periodic Out Counter</li> <li>Byte 10-11: Accumulated In Counter</li> <li>Byte 12-13: Accumulated Out Counter</li> </ul>

### Note:

1. The device only uploads no more than 300 data records per range enquiry.
2. When enquiring the data in a specific time point, it will upload the data which is the closest to the search point within the reporting interval range. For example, if the device's reporting interval is 10 minutes and users send a command to search for data stored at 17:00, it will upload these data, if the device finds any data stored in 17:00. If not, it will search for data between 16:50 to

17:10 and upload the data which is the closest to 17:00.

**Example:**

1. Enquire historical data between 2023/8/28 13:30:00 to 2023/8/28 13:40:00.

fd6c d830ec64 3033ec64		
Channel	Type	Value
fd	6c (Enquire data in time range)	Start time: d830ec64=> 64ec30d8 = 1693200600s = 2023/8/28 13:30:00 End time: 3033ec64 => 64cc3330 = 1693201200s = 2023/8/28 13:40:00

Reply:

fc6c 00		
Channel	Type	Value
fc	6c (Enquire data in time range)	00: data enquiry success

20ce 1932ec64 01 0700 0300 4a00 3800			
Channel	Type	Time Stamp	Value
20	ce (Historical Data)	1932ec64 => 64ec3219 = 1693200921s = 2023/8/28 13:35:21	01=Periodic Counter + Accumulated Counter Period In: 0700=>0007=7 Period Out: 0300=>0003=3 Accumulated In: 4a00=>004a=74 Accumulated Out: 3800=>0038=56

**-END-**