

WATTNODE[®] PULSE

Installation and Operation Manual

- WNB-3Y-208-P
- WNB-3Y-400-P
- WNB-3Y-480-P
- WNB-3Y-600-P
- WNB-3D-240-P
- WNB-3D-400-P
- WNB-3D-480-P

Information in this document is subject to change without notice.

©2007-2011 Continental Control Systems, LLC. All rights reserved.

Printed in the United States of America.

Document Number: WNB-P-V17b

Revision Date: November 30, 2011

Continental Control Systems, LLC.

3131 Indian Rd., Suite A

Boulder, CO 80301

(303) 444-7422

FAX: (303) 444-2903

E-mail: techsupport@ccontrolsys.com

Web: <http://www.ccontrolsys.com>

WattNode is a registered trademark of Continental Control Systems, LLC.

FCC Information

This equipment has been tested and complies with the limits for a Class B digital device, pursuant to part 15 of the FCC Rules. Operation is subject to the following two conditions: (1) This device may not cause harmful interference, and (2) this device must accept any interference received, including interference that may cause undesired operation.

The FCC limits are designed to provide reasonable protection against harmful interference in a residential installation. This equipment generates, uses and can radiate radio frequency energy and, if not installed and used in accordance with the instructions, may cause harmful interference to radio communications. However, there is no guarantee that interference will not occur in a particular installation. If this equipment does cause harmful interference to radio or television reception, which can be determined by turning the equipment off and on, the user is encouraged to try to correct the interference by one or more of the following measures:

- Reorient or relocate the receiving antenna.
- Increase the separation between the equipment and receiver.
- Connect the equipment into an outlet on a circuit different from that to which the receiver is connected.
- Consult the dealer or an experienced radio/TV technician to help.

Contents

Overview	4
Pulse Outputs.....	4
Diagnostic LEDs	4
Current Transformers.....	4
Additional Literature.....	4
Front Label.....	5
Installation	7
Precautions	7
Electrical Service Types.....	8
Single-Phase Two-Wire with Neutral	8
Single-Phase Three-Wire (Mid-Point Neutral)	9
Single-Phase Two-Wire without Neutral	10
Three-Phase Four-Wire Wye.....	11
Three-Phase Three-Wire Delta Without Neutral.....	12
Three-Phase Four-Wire Delta (Wild Leg)	12
Grounded Leg Service	12
Mounting	13
Selecting Current Transformers	14
Connecting Current Transformers	15
Circuit Protection.....	16
Connecting Voltage Terminals.....	17
Connecting Pulse Outputs.....	17
Output Assignments.....	18
Pull-Up Resistor Selection	19
Installation Summary	19
Installation LED Diagnostics.....	20
Measurement Troubleshooting.....	22
Operating Instructions.....	24
Pulse Outputs.....	24
Power and Energy Computation	25
Power and Energy Equations.....	27
Maintenance and Repair.....	29
Specifications	30
Models	30
Model Options	30
Accuracy.....	31
Measurement	32
Pulse Outputs.....	32
Electrical	33
Certifications	35
Environmental.....	35
Mechanical.....	35
Current Transformers.....	35
Warranty.....	37
Limitation of Liability	37

Overview

Congratulations on your purchase of the WattNode® Pulse watt/watt-hour transducer/meter. It accurately measures energy and power in a compact package. The WattNode meter can fit in existing electric service panels avoiding the costly installation of sub-panels and associated wiring. It is designed for use in demand side management (DSM), sub-metering, and energy monitoring applications. The WattNode meter generates pulses proportional to total watt-hours. The pulse rate or frequency is proportional to the instantaneous power. Models are available for single-phase and three-phase, wye and delta configurations for voltages from 120 Vac to 600 Vac at 50 and 60 Hz.

Pulse Outputs

The WattNode meter generates pulse outputs using one or more optoisolators (also called photocouplers). These provide 5000 Vac of electrical isolation. The pulse outputs can interface to monitoring or data logging hardware without concerns about interference, ground loops, shock hazard, etc.

The standard Pulse WattNode meter makes bidirectional power measurements (energy consumption and energy production). It can be used for conventional power and energy measurement as well as for net metering and photovoltaic (PV) applications.

- **Option P3** - The per-phase measurement option measures one, two, or three separate branch circuits with a single meter, saving money and space.
- **Option PV** - The photovoltaic option measures residential PV systems. One WattNode meter measures the bidirectional total house energy, and the PV (or wind) generated energy. See **Manual Supplement MS-10: Option PV (Photovoltaic)** for details.
- **Options DPO** - The dual positive outputs option behaves exactly like the standard bidirectional model, but with the addition of a second positive pulse output channel (on the **P3** output terminal). This allows you to connect to two devices, such as a display and a data logger. See **Manual Supplement MS-11: Option DPO (Dual Positive Outputs)** for details.

See **Model Options (p. 30)** in the **Specifications** section below for details and more options.

Diagnostic LEDs

The Pulse WattNode meter includes three diagnostic LEDs—one per phase. During normal operation, these LEDs flash on and off, with the speed of flashing roughly proportional to the power on each phase. The LEDs flash green for positive power and red for negative power. Other conditions are signaled with different LED patterns. See the **Installation LED Diagnostics (p. 20)** section for full details.

Current Transformers

The WattNode meter uses solid-core (toroidal), split-core (opening), and bus-bar style current transformers (CTs) with a full-scale voltage output of 0.33333 Vac. Split-core and bus-bar CTs are easier to install without disconnecting the circuit being measured. Solid-core CTs are more compact, generally more accurate, and less expensive, but installation requires that you disconnect the circuit to install the CTs.

Additional Literature

- [WattNode Advanced Pulse - Quick Install Guide](#)
- [Manual Supplement MS-10: Option PV \(Photovoltaic\)](#)
- [Manual Supplement MS-11: Option DPO \(Dual Positive Outputs\)](#)
- [Manual Supplement MS-17: Option PW \(Pulse Width\)](#)
- [Manual Supplement MS-19: Option SSR \(Solid-State Relay\)](#)

Front Label

This section describes all the connections, information, and symbols that appear on the front label.

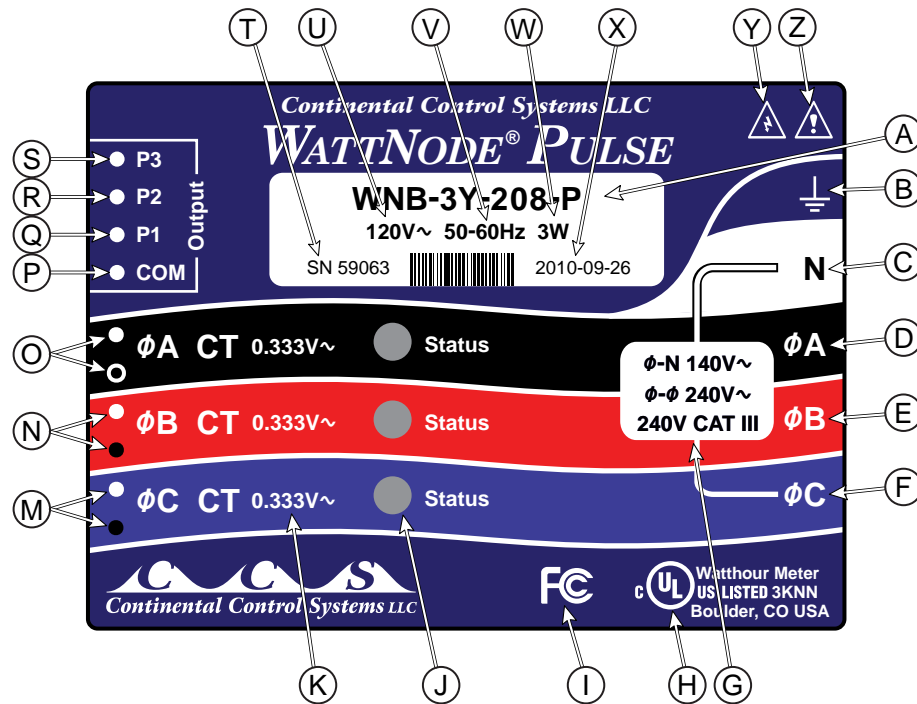

Figure 1: Front Label Diagram

- A: WattNode model number.** The “WNB” indicates a second generation WattNode meter with diagnostic LEDs and up to three pulse output channels. The “3” indicates a three-phase model. The “Y” or “D” indicates wye or delta models, although delta models can measure wye circuits (the difference is in the power supply). The “208” (or other value) indicates the nominal line-to-line voltage. Finally, the “P” indicates pulse output.
- B: Functional ground.** This terminal should be connected to earth ground if possible. It is not required for safety grounding, but ensures maximum meter accuracy.
- C: Neutral.** This terminal “N” should be connected to neutral when available.
- D, E, F: Line voltage inputs.** These terminals connect to the ϕA (phase A), ϕB (phase B), and ϕC (phase C) electric mains. On wye models the meter is powered from ϕA and **N** terminals. On delta models, the meter is powered from the ϕA and ϕB terminals.
- G: Line voltage measurement ratings.** This block lists the nominal line-to-neutral “ $\phi-N 120V\sim$ ” voltage, line-to-line “ $\phi-\phi 240V\sim$ ” voltage, and the rated measurement voltage and category “240V CAT III” for this WattNode model. See the [Specifications \(p. 30\)](#) for more information about the measurement voltage and category.
- H: UL Listing mark.** This shows the UL and cUL (Canadian) listing mark and number “3KNN”.
- I: FCC Mark.** This logo indicates that the meter complied with part 15 of the FCC rules.
- J: Status LEDs.** These are status LEDs used to verify and diagnose meter operation. See [Installation LED Diagnostics \(p. 20\)](#) for details.
- K: Current transformer (CT) voltage rating.** These markings “0.333V \sim ” indicate that the meter must be used with CTs that generate a full-scale output of 0.333 Vac (333 millivolts).

M, N, O: Current transformer (CT) inputs. These indicate CT screw terminals. Note the white and black circles at the left edge of the label: these indicate the color of the CT wire that should be inserted into the corresponding screw terminal. The terminals marked with black circles are connected together internally.

P: Pulse output common (COM). This is the common terminal for all three pulse output channels. This terminal should be more negative than the **P1**, **P2**, and **P3** terminals (unless the meter was ordered with **Option SSR**).

Q, R, S: Pulse outputs (P1, P2, P3). These are the pulse output channels. Different models use one, two, or three channels. They should always be positive relative to the common terminal.

T: Serial number. This shows the meter serial number and options if any are selected. The barcode contains the serial number in Code 128C format.

U: Mains supply rated voltage. This is the rated supply voltage for this model. The **V~** indicates AC voltage. For wye models, this voltage should appear between the **N** and **ΦA** terminals. For delta models, this voltage should appear between the **ΦA** and **ΦB** terminals.

V: Mains frequencies. This indicates the rated mains frequencies for the meter.



W: Maximum rated power. This is the maximum power consumption (watts) for this model.

X: Manufacture date. This is the date of manufacture for the WattNode meter.

Y: Caution, risk of electrical shock. This symbol indicates that there is a risk of electric shock when installing and operating the meter if the installation instructions are not followed correctly.

Z: Attention - consult Manual. This symbol indicates that there can be danger when installing and operating the meter if the installation instructions are not followed correctly.

Symbols

	Attention - Consult Installation and Operation Manual	Read, understand, and follow all instructions in this Installation and Operation Manual including all warnings, cautions, and precautions before installing and using the product.
	Caution – Risk of Electrical Shock	Potential Shock Hazard from Dangerous High Voltage.
	CE Marking	Complies with the regulations of the European Union for Product Safety and Electro-Magnetic Compatibility. <ul style="list-style-type: none"> • Low Voltage Directive – EN 61010-1: 2001 • EMC Directive – EN 61327: 1997 + A1/1998 + A2/2001

Installation

Precautions



DANGER – HAZARDOUS VOLTAGES

WARNING - These installation/servicing instructions are for use by qualified personnel only. To avoid electrical shock, do not perform any servicing other than that contained in the operating instructions unless you are qualified to do so.

Always adhere to the following checklist:

- 1) Only qualified personnel or **licensed electricians** should install the WattNode meter. The mains voltages of 120 Vac to 600 Vac can be lethal!
- 2) Follow all applicable local and national electrical and safety codes.
- 3) Install the meter in an electrical enclosure (panel or junction box) or in a limited access electrical room.
- 4) Verify that circuit voltages and currents are within the proper range for the meter model.
- 5) Use only UL recognized current transformers (CTs) with built-in burden resistors, that generate 0.333 Vac (333 millivolts AC) at rated current. **Do not use current output (ratio) CTs such as 1 amp or 5 amp output CTs: they will destroy the meter and may create a shock hazard.** See [Current Transformers \(p. 35\)](#) for CT maximum input current ratings.
- 6) Ensure that the line voltage inputs to the meter are protected by fuses or circuit breakers (not needed for the neutral wire). See [Circuit Protection \(p. 16\)](#) for details.
- 7) Equipment must be disconnected from the HAZARDOUS LIVE voltages before access.
- 8) The terminal block screws are **not** insulated. Do not contact metal tools to the screw terminals if the circuit is live!
- 9) Do not place more than one line voltage wire in a screw terminal; use wire nuts instead. You may use more than one CT wire per screw terminal.
- 10) Before applying power, check that all the wires are securely installed by tugging on each wire.
- 11) Do not install the meter where it may be exposed to temperatures below -30°C or above 55°C , excessive moisture, dust, salt spray, or other contamination. The meter requires an environment no worse than pollution degree 2 (normally only non-conductive pollution; occasionally, a temporary conductivity caused by condensation must be expected).
- 12) Do not drill mounting holes using the meter as a guide; the drill chuck can damage the screw terminals and metal shavings can fall into the connectors, causing an arc risk.
- 13) If the meter is installed incorrectly, the safety protections may be impaired.

Electrical Service Types

Below is a list of service types, with connections and recommended models. Note: the ground connection improves measurement accuracy, but is not required for safety.

Model	Type	Line-to-Neutral	Line-to-Line	Electrical Service Types
WNB-3Y-208-P	Wye	120 Vac	208-240 Vac	1 Phase 2 Wire 120V with neutral 1 Phase 3 Wire 120V/240V with neutral 3 Phase 4 Wire Wye 120V/208V with neutral
WNB-3Y-400-P	Wye	230 Vac	400 Vac	1 Phase 2 Wire 230V with neutral 3 Phase 4 Wire Wye 230V/400V with neutral
WNB-3Y-480-P	Wye	277 Vac	480 Vac	3 Phase 4 Wire Wye 277V/480V with neutral 1 Phase 2 Wire 277V with neutral
WNB-3Y-600-P	Wye	347 Vac	600 Vac	3 Phase 4 Wire Wye 347V/600V with neutral
WNB-3D-240-P	Delta or Wye	120-140 Vac	208-240 Vac	1 Phase 2 Wire 208V (no neutral) 1 Phase 2 Wire 240V (no neutral) 1 Phase 3 Wire 120V/240V with neutral 3 Phase 3 Wire Delta 208V (no neutral) 3 Phase 4 Wire Wye 120V/208V with neutral 3 Phase 4 Wire Delta 120/208/240V with neutral
WNB-3D-400-P	Delta or Wye	230 Vac	400 Vac	3 Phase 3 Wire Delta 400V (no neutral) 3 Phase 4 Wire Wye 230V/400V with neutral
WNB-3D-480-P	Delta or Wye	277 Vac	480 Vac	3 Phase 3 Wire Delta 480V (no neutral) 3 Phase 4 Wire Wye 277V/480V with neutral 3 Phase 4 Wire Delta 240/415/480V with neutral

*The wire count does NOT include ground. It only includes neutral (if present) and phase wires.

Table 1: WattNode Models

Single-Phase Two-Wire with Neutral

This configuration is most often seen in homes and offices. The two conductors are neutral and line. For these models, the meter is powered from the **N** and ϕ **A** terminals.

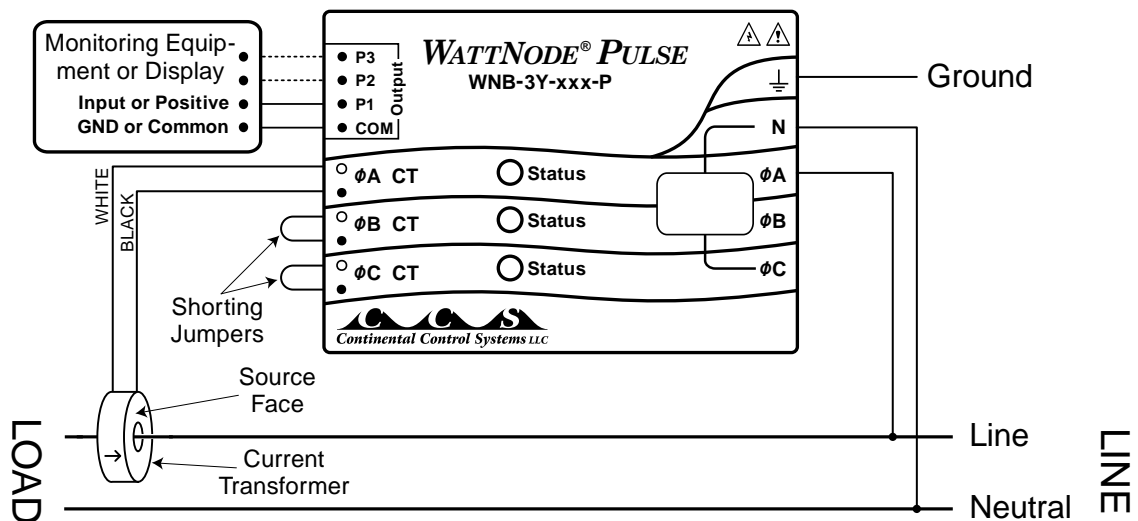

Figure 2: Single-Phase Two-Wire Connection

Recommended WattNode Models

The following table shows the WattNode models that should be used, depending on the line to neutral voltage.

Line to Neutral Voltage	WattNode Model
120 Vac	WNB-3Y-208-P
230 Vac	WNB-3Y-400-P
277 Vac	WNB-3Y-480-P

Single-Phase Three-Wire (Mid-Point Neutral)

This configuration is seen in North American residential and commercial service with 240 Vac for large appliances. The three conductors are a mid-point neutral and two line voltage wires with AC waveforms 180° out of phase; this results in 120 Vac between either line conductors (phase) and neutral, and 240 Vac (or sometimes 208 Vac) between the two line conductors (phases).

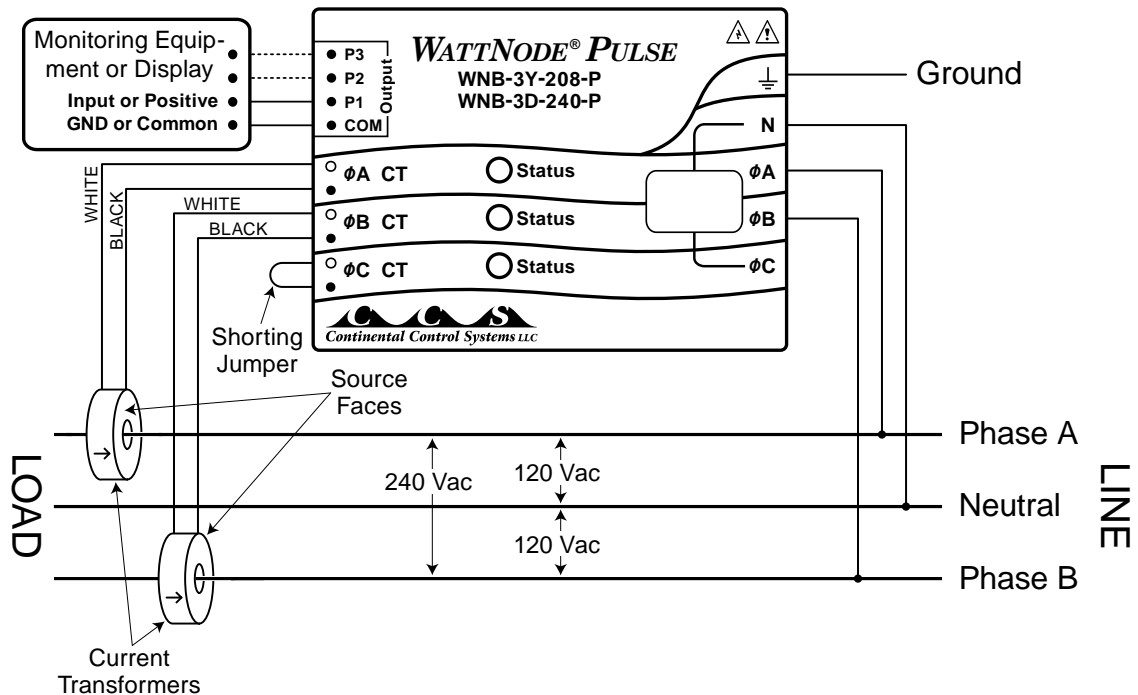

Figure 3: Single-Phase Three-Wire Connection

Recommended WattNode Models

The following table shows the WattNode models that can be used. If neutral may or may not be present, you should use the WNB-3D-240-P (see [Single-Phase Two-Wire without Neutral](#) below). If neutral is present, it must be connected for accurate measurements. If phase B may not be present, you should use the WNB-3Y-208-P (see [Single-Phase Two-Wire with Neutral](#) above).

Meter Power Source	WattNode Model
N and φA (Neutral and Phase A)	WNB-3Y-208-P
φA and φB (Phase A and Phase B)	WNB-3D-240-P

Single-Phase Two-Wire without Neutral

This is seen in residential and commercial service with 208 to 240 Vac for large appliances. The two conductors have AC waveforms 120° or 180° out of phase. Neutral is not used. For this configuration, the meter is powered from the ϕA and ϕB (phase A and phase B) terminals.

For best accuracy, we recommend connecting the **N** (neutral) terminal to the ground terminal. This will not cause ground current to flow because the neutral terminal does not power the meter.

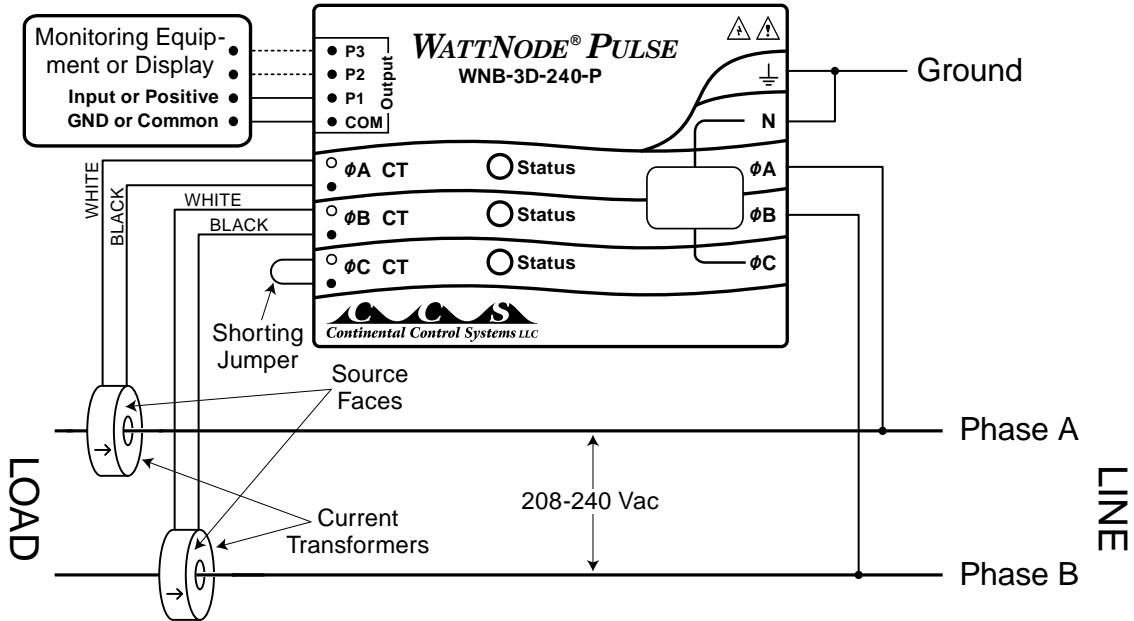

Figure 4: Single-Phase Two-Wire without Neutral Connection

Recommended WattNode Model

This configuration is normally measured with the following WattNode model.

Line-to-Line Voltage	WattNode Model
208 - 240 Vac	WNB-3D-240-P

If neutral is available, you may also use the WNB-3Y-208-P model. If you use the WNB-3Y-208-P, you will need to hook up the meter as shown in section [Single-Phase Three-Wire \(Mid-Point Neutral\)](#) and connect neutral. You will need two CTs.

If one of the conductors (phase A or phase B) is grounded, see [Grounded Leg Service](#) below for recommendations.

Three-Phase Four-Wire Wye

This is typically seen in commercial and industrial environments. The conductors are neutral and three power lines with AC waveforms shifted 120° between phases. The line voltage conductors may be connected to the ϕA , ϕB , and ϕC terminals in any order, **so long as the CTs are connected to matching phases**. It is important that you connect **N** (neutral) for accurate measurements. For wye “-3Y” models, the meter is powered from the **N** and ϕA terminals.

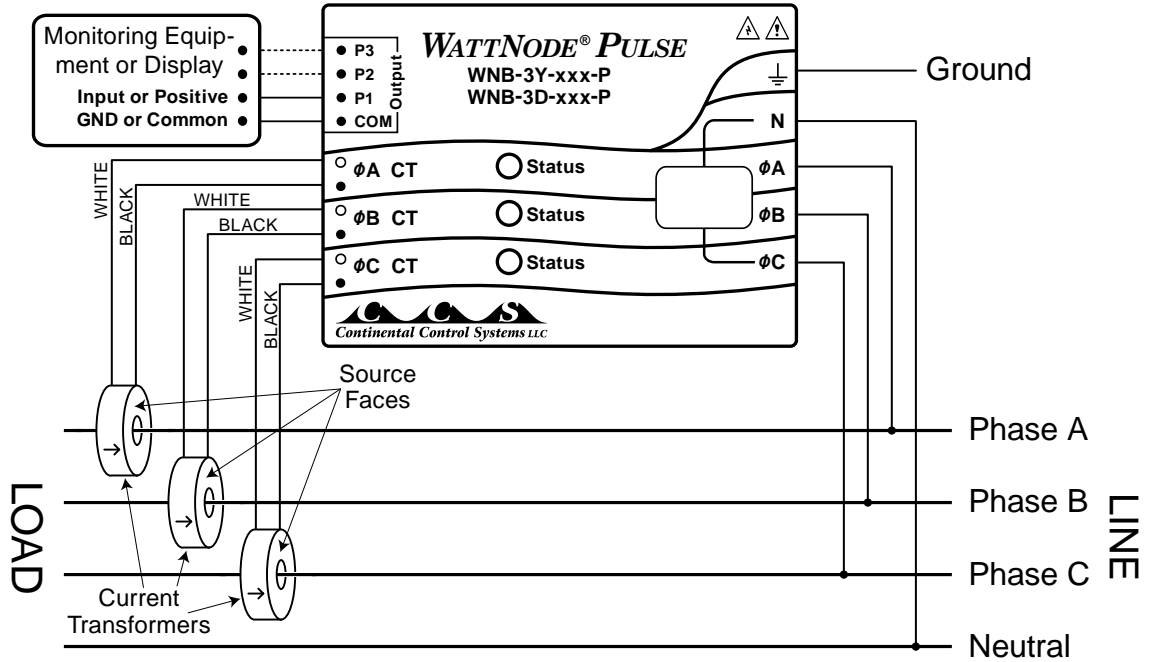

Figure 5: Three-Phase Four-Wire Wye Connection

Recommended WattNode Models

The following table shows the WattNode models that should be used, depending on the line-to-neutral voltage and line-to-line voltage (also called phase-to-phase voltage).

Line-to-Neutral Voltage	Line-to-Line Voltage	WattNode Model
120 Vac	208 Vac	WNB-3Y-208-P
230 Vac	400 Vac	WNB-3Y-400-P
277 Vac	480 Vac	WNB-3Y-480-P
347 Vac	600 Vac	WNB-3Y-600-P

Note: you may also use the following delta WattNode models to measure three-phase four-wire wye circuits. The only difference is that delta WattNode models are powered from ϕA and ϕB , rather than **N** and ϕA . If neutral is present, it must be connected for accurate measurements.

Line-to-Neutral Voltage	Line-to-Line Voltage	WattNode Model
120 - 140 Vac	208 - 240 Vac	WNB-3D-240-P
230 Vac	400 Vac	WNB-3D-400-P
277 Vac	480 Vac	WNB-3D-480-P

Three-Phase Three-Wire Delta Without Neutral

This is typically seen in manufacturing and industrial environments. There is no neutral wire, just three power lines with AC waveforms shifted 120° between the successive phases. With this configuration, the line voltage wires may be connected to the ϕA , ϕB , and ϕC terminals in any order, **so long as the CTs are connected to matching phases**. For these models, the meter is powered from the ϕA and ϕB (phase A and phase B) terminals. Note: all delta WattNode models provide a neutral connection **N**, which allows delta WattNode models to measure both wye and delta configurations.

For best accuracy, we recommend connecting the **N** (neutral) terminal to earth ground. This will not cause ground current to flow because the neutral terminal is not used to power the meter.

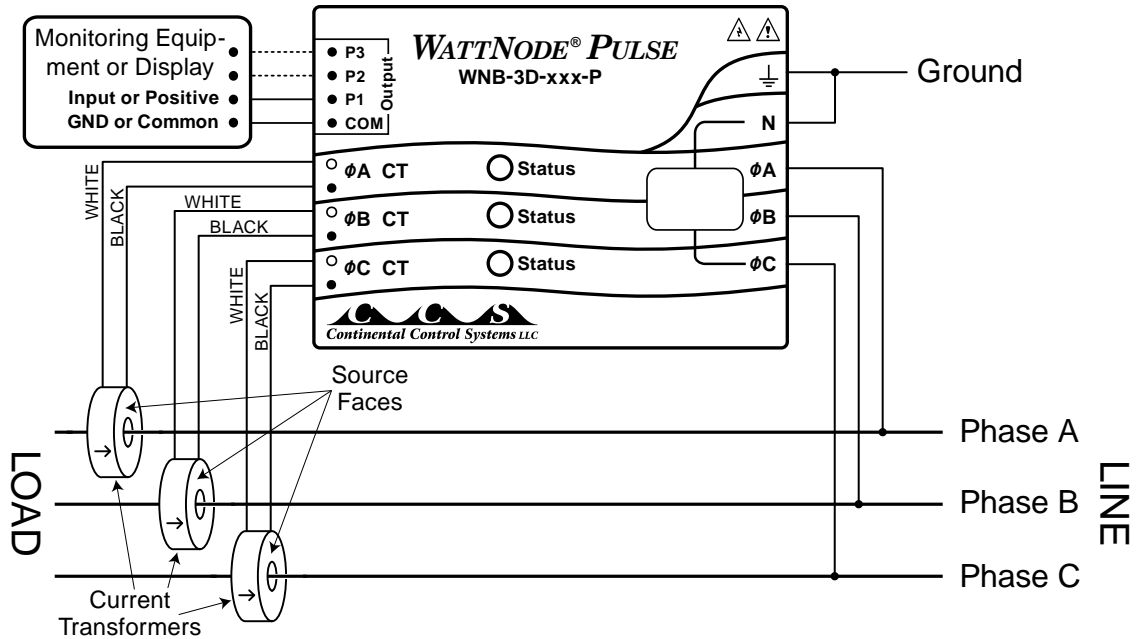

Figure 6: Three-Phase Three-Wire Delta Connection

Recommended WattNode Models

The following table shows the WattNode models that should be used, depending on the line-to-line voltage (also called phase-to-phase voltage).

Line-to-Line Voltage	WattNode Model
208 - 240 Vac	WNB-3D-240-P
400 Vac	WNB-3D-400-P
480 Vac	WNB-3D-480-P

Three-Phase Four-Wire Delta (Wild Leg)

The uncommon four-wire delta electrical service is a three-phase delta service with a center-tap on one of the transformer windings to create a neutral for single-phase loads.

See http://www.ccontrols.com/w/Four_Wire_Delta_Circuits for details.

Grounded Leg Service

In rare cases with delta services or single-phase two-wire services without neutral, one of the phases may be grounded. You can check for this by using a multimeter (DMM) to measure the voltage between each phase and ground. If you see a reading between 0 and 5 Vac, that leg is probably grounded (sometimes called a “grounded delta”).

The WattNode meter will correctly measure services with a grounded leg, but the measured power for the grounded phase will be zero and the status LED will not light for whichever phase is grounded, because the voltage is near zero.

For optimum accuracy with a grounded leg, you should also connect the **N** (neutral) terminal on the meter to the ground terminal; this will not cause any ground current to flow because the neutral terminal is not used to power the meter. If you have a grounded leg configuration, you can save money by removing the CT for the grounded phase, since all the power will be measured on the non-grounded phases. We recommend putting the grounded leg on the **ΦB** or **ΦC** inputs and attaching a note to the meter indicating this configuration for future reference.

Mounting

Protect the WattNode meter from moisture, direct sunlight, high temperatures, and conductive pollution (salt spray, metal dust, etc.) If moisture or conductive pollution may be present, use an IP 66 or NEMA 4 rated enclosure to protect the meter. Due to its exposed screw terminals, the meter must be installed in an electrical service panel, an enclosure, or an electrical room. The meter may be installed in any orientation, directly to a wall of an electrical panel or junction box.

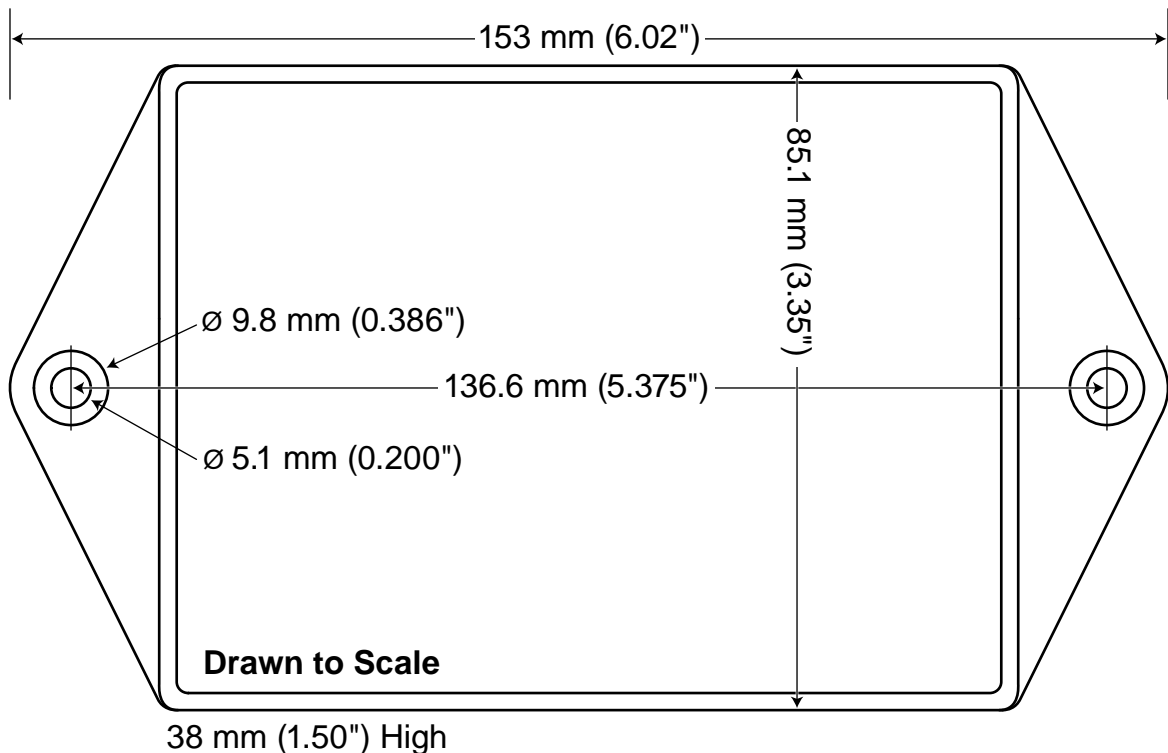

Figure 7: WattNode Meter Dimensions

The WattNode meter has two mounting holes spaced 5.375 inches (137 mm) apart (center to center). These mounting holes are normally obscured by the detachable screw terminals. Remove the screw terminals by pulling outward while rocking from end to end. The meter or **Figure 7** may be used as a template to mark mounting hole positions, but **do not drill the holes with the meter in the mounting position** because the drill may damage the connectors and leave drill shavings in the connectors.

You may mount the meter with the supplied #8 self-tapping sheet metal screws using 1/8 inch pilot hole (3.2 mm). Or you may use hook-and-loop fasteners. If you use screws, avoid over-tightening which can crack the case. If you don't use the supplied screws, the following sizes should work (**bold** are preferred); use washers if the screws could pull through the mounting holes

Screw Style	U.S.A. UTS Sizes	Metric Sizes
Pan Head or Round Head	#6, #8, #10	M3.5, M4, M5
Truss Head	#6, #8	M3.5, M4
Hex Washer Head (integrated washer)	#6, #8	M3.5, M4
Hex Head (add washer)	#6, #8, #10	M3.5, M4, M5

Table 2: Mounting Screws

Selecting Current Transformers

The rated full-scale current of the CTs should normally be chosen somewhat above the maximum current of the circuit being measured (see **Current Crest Factor** below for more details). In some cases, you might select CTs with a lower rated current to optimize accuracy at lower current readings. Take care that the maximum allowable current for the CT can not be exceeded without tripping a circuit breaker or fuse; see **Current Transformers (p. 35)**.

We only offer CTs that measure AC current, not DC current. Significant DC current can saturate the CT magnetic core, reducing the AC accuracy. Most loads only have AC current, but some rare loads draw DC current, which can cause measurement errors. See our website for more information: http://www.ccontrols.com/w/DC_Current_and_Half-Wave_Rectified_Loads.

CTs can measure lower currents than they were designed for by passing the wire through the CT more than once. For example, to measure currents up to 1 amp with a 5 amp CT, loop the wire through the CT five times. The CT is now effectively a 1 amp CT instead of a 5 amp CT. The effective current rating of the CT is the labeled rating divided by the number of times that the wire passes through the CT.

If you are using the measurement phases of the WattNode (**ΦA**, **ΦB**, and **ΦC**) to measure different circuits (as with **Option P3**), you can use CTs with different rated current on the different phases.

Current Crest Factor

The term “current crest factor” is used to describe the ratio of the peak current to the RMS current (the RMS current is the value reported by multimeters and the WattNode meter). Resistive loads like heaters and incandescent lights have nearly sinusoidal current waveforms with a crest factor near 1.4. Power factor corrected loads such as electronic lighting ballasts and computer power supplies typically have a crest factor of 1.4 to 1.5. Battery chargers, VFD motor controls, and other nonlinear loads can have current crest factors ranging from 2.0 to 3.0, and even higher.

High current crest factors are usually not an issue when metering whole building loads, but can be a concern when metering individual loads with high current crest factors. If the peak current is too high, the meter’s CT inputs can clip, causing inaccurate readings.

This means that when measuring loads with high current crest factors, you may want to be conservative in selecting the CT rated current. For example, if your load draws 10 amps RMS, but has a crest factor of 3.0, then the peak current is 30 amps. If you use a 15 amp CT, the meter will not be able to accurately measure the 30 amp peak current. Note: this is a limitation of the meter measurement circuitry, not the CT.

The following graph shows the maximum RMS current for accurate measurements as a function of the current waveform crest factor. The current is shown as a percentage of CT rated current. For example, if you have a 10 amp load with a crest factor of 2.0, the maximum CT current is approximately 85%. Eighty-five percent of 15 amps is 12.75, which is higher than 10 amps, so your measurements should be accurate. On the other hand, if you have a 40 amp load with a crest factor of 4.0, the maximum CT current is 42%. Forty-two percent of a 100 amp CT is 42 amps, so you would need a 100 amp CT to accurately measure this 40 amp load.

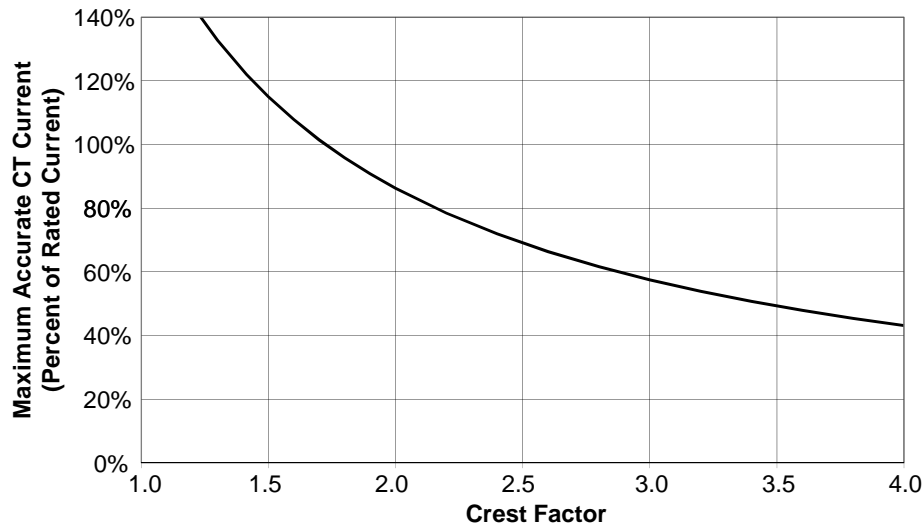

Figure 8: Maximum CT Current vs. Crest Factor

You frequently won't know the crest factor for your load. In this case, it's generally safe to assume the crest factor will fall in the 1.4 to 2.5 range and select CTs with a rated current roughly 150% of the expected RMS current. So if you expect to be measuring currents up to 30 amps, select a 50 amp CT.

Connecting Current Transformers

- Use only UL recognized current transformers (CTs) with built-in burden resistors that generate 0.33333 Vac (333.33 millivolts AC) at rated current. See [Current Transformers \(p. 35\)](#) for the maximum input current ratings.
- **Do not** use ratio (current output) CTs such as 1 amp or 5 amp output CTs: they will **destroy** the meter and present a shock hazard! These are commonly labelled with a ratio like 100:5.
- Find the arrow or label "THIS SIDE TOWARD SOURCE" on the CT and face toward the current source: generally the utility meter or the circuit breaker for branch circuits. If CTs are mounted backwards or with their white and black wires reversed the measured power will be negative. The diagnostic LEDs indicates negative power with flashing red LEDs.
- Be careful to match up the current transformers to the voltage phases being measured. Make sure the **ΦA CT** is measuring the line voltage connected to **ΦA**, and the same for phases B and C. Use the supplied colored labels or tape to identify the wires.
- To prevent magnetic interference, the CTs on different phases should be separated by 1 inch (25 mm). The line voltage conductors for each phase should be separated by at least 1 inch (25 mm) from each other and from neutral.
- For best accuracy, the CT opening should not be much larger than the conductor. If the CT opening is much larger, position the conductor in the center of the CT opening.
- Because CT signals are susceptible to interference, we recommend keeping the CT wires short and cutting off any excess length. It is generally better to install the meter near the line voltage conductors instead of extending the CT wires. However, you may extend the CT wires by 300 feet (100 m) or more by using shielded twisted-pair cable and by running the CT wires away from high current and line voltage conductors.
- OPTIONAL: if you see spurious readings on unused phases, jumper the unused CT inputs.

To connect CTs, pass the wire to be measured through the CT and connect the CT to the meter. **Always remove power before disconnecting any live wires.** Put the line conductors through the CTs as shown in the section [Electrical Service Types \(p. 8\)](#). You may measure generated power by treating the generator as the source.

For solid-core CTs, disconnect the line voltage conductor to install it through the CT opening.

Split-core and bus-bar CTs can be opened for installation around a wire by pulling the removable section straight away from the rest of the CT or unhooking the latch; it may require a strong pull. Some CT models include thumb-screws to secure the opening. The removable section may fit only one way, so match up the steel core pieces when closing the CT. If the CT seems to jam and will not close, the steel core pieces are probably not aligned correctly; **DO NOT FORCE** together. Instead, reposition or rock the removable portion until the CT closes without excessive force. A nylon cable tie can be secured around the CT to prevent inadvertent opening.

Some split-core CT models have flat mating surfaces. When installing this type of CT, make sure that mating surfaces are clean. Any debris between the mating surfaces will increase the gap, decreasing accuracy.

Next, connect the CT lead wires to the meter terminals labeled **ΦA CT**, **ΦB CT**, and **ΦC CT**. Route the twisted black and white wires from the CT to the meter. We recommend cutting off any excess length to reduce the risk of interference. Strip 1/4 inch (6 mm) of insulation off the ends of the CT leads and connect to the six position black screw terminal block. Connect each CT lead with the white wire aligned with the white dot on the label, and the black wire aligned with the black dot. Note the order in which the phases are connected, as the voltage phases **must** match the current phases for accurate power measurement.

Finally record the CT rated current as part of the installation record for each meter. If the conductors being measured are passed through the CTs more than once, then the recorded rated CT current is divided by the number of times that the conductor passes through the CT.

Circuit Protection

The WattNode meter is considered “permanently connected equipment”, because it does not use a conventional power cord that can be easily unplugged. **Permanently connected equipment must have overcurrent protection and be installed with a means to disconnect the equipment.**

- A switch, disconnect, or circuit breaker may be used to disconnect the meter and must be as close as practical to the meter. If a switch or disconnect is used, then there must also be a fuse or circuit breaker of appropriate rating protecting the meter.
- WattNode meters only draw 10-30 milliamps; CCS recommends using circuit breakers or fuses rated for between 0.5 amps and 20 amps and rated for the line voltages and the current interrupting rating required.
- The circuit breakers or fuses must protect the ungrounded supply conductors (the terminals labeled **ΦA**, **ΦB**, and **ΦC**). If neutral is also protected (this is rare), then the overcurrent protection device must interrupt neutral and the supply conductors simultaneously.
- Any switches or disconnects should have at least a 1 amp rating and must be rated for the line voltages.
- The circuit protection / disconnect system must meet IEC 60947-1 and IEC 60947-3, as well as all national and local electrical codes.
- The line voltage connections should be made with wire rated for use in a service panel or junction box with a voltage rating sufficient for the highest voltage present. CCS recommends 14 or 12 AWG (1.5 mm² or 2.5 mm²) stranded wire, rated for 300 or 600 volts. Solid wire may be used, but must be routed carefully to avoid putting excessive stress on the screw terminal.
- The WattNode meter has an earth connection, which should be connected for maximum accuracy. However, this earth connection is not used for safety (protective) earthing.

Connecting Voltage Terminals

Always turn off or disconnect power before connecting the voltage inputs to the meter. Connect each phase voltage to the appropriate input on the green terminal block; also connect ground and neutral (if required).

The voltage inputs to the meter do not need to be powered from the same branch circuit as the load being monitored. In other words, if you have a three-phase panel with a 100 A three-pole breaker powering a motor that you wish to monitor, you can power the meter (or several meters) from a separate 20 A three-pole breaker installed in the same, or even adjacent panel, so long as the load and voltage connections are supplied from the same electric service.

The green screw terminals handle wire up to 12 AWG (2.5 mm²). Strip the wires to expose 1/4" (6 mm) of bare copper. When wiring the meter, do not put more than one wire under a screw. If you need to distribute power to other meters, use wire nuts or a power distribution block. The section [Electrical Service Types \(p. 8\)](#) shows the proper connections for the different meter models and electrical services. **Verify that the voltage line phases match the CT phases.**

If there is any doubt that the meter voltage rating is correct for the circuit being measured, unplug the green terminal block (to protect the meter), turn on the power, and use a voltmeter to compare the voltages (probe the terminal block screws) to the values in the white box on the meter front label. After testing, plug in the terminal block, making sure that is pushed in all the way.

The WattNode meter is powered from the voltage inputs: ΦA (phase A) to **N** (neutral) for wye “-3Y” models, or ΦA to ΦB for delta “-3D” models. If the meter is not receiving at least 80% of the nominal line voltage, it may stop operating. Since the meter consumes a small amount of power itself (typically 1-3 watts), you may wish to power the meter from a separate circuit or place the current transformers downstream of the meter, so its power consumption is not measured

For best accuracy, always connect the **N** (neutral) terminal on the meter. If you are using a delta meter and the circuit has no neutral, then jumper the earth ground to the **N** (neutral) terminal.

When power is first applied to the meter, check that the LEDs behave normally (see [Installation LED Diagnostics \(p. 20\)](#) below): if you see the LEDs flashing red-green-red-green, then disconnect the power immediately! This indicates the line voltage is too high for this model.

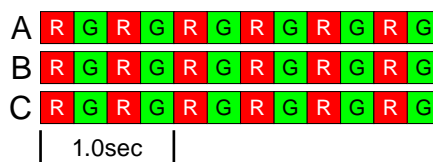

Figure 9: WattNode LED Overvoltage Warning

Connecting Pulse Outputs

- The outputs **P1**, **P2**, and **P3** should not be connected to negative voltages (except with **Option SSR**), or to voltages greater than +60 Vdc.
- The recommended maximum current through the pulse output optoisolators is 5 mA, although they will generally switch 8-10 mA. If you need to switch higher currents, contact us about **Option SSR** (solid-state relay); see [Specifications - Option SSR Outputs \(p. 33\)](#).
- The outputs are isolated (5000 Vac RMS) from dangerous voltages, so you can connect them with the meter powered. The outputs are also isolated from the meter's earth ground and neutral connections.
- If the output wiring is located near line voltage wiring, use wires or cables rated for the highest voltage present, generally 300V or 600V rated wire.
- If this cable will be in the presence of bare conductors, such as bus-bars, it should be double insulated or jacketed.
- When wiring over long distances, use shielded twisted-pair cable to prevent interference.

The pulse output channels are the collector and emitter of an optoisolator transistor (also called a photocoupler) controlled by the meter's pulse stream (see [Option SSR Outputs \(p. 33\)](#) for solid-state relay outputs). These outputs may be connected to most data monitoring devices that expect a contact closure or relay input: data loggers, energy management systems, etc. Most of these devices provide excitation voltage with internal pull-up resistors. If your device does not, the following schematic illustrates connecting pull-up resistors on all three optoisolator outputs with a pull-up voltage of 5 Vdc.

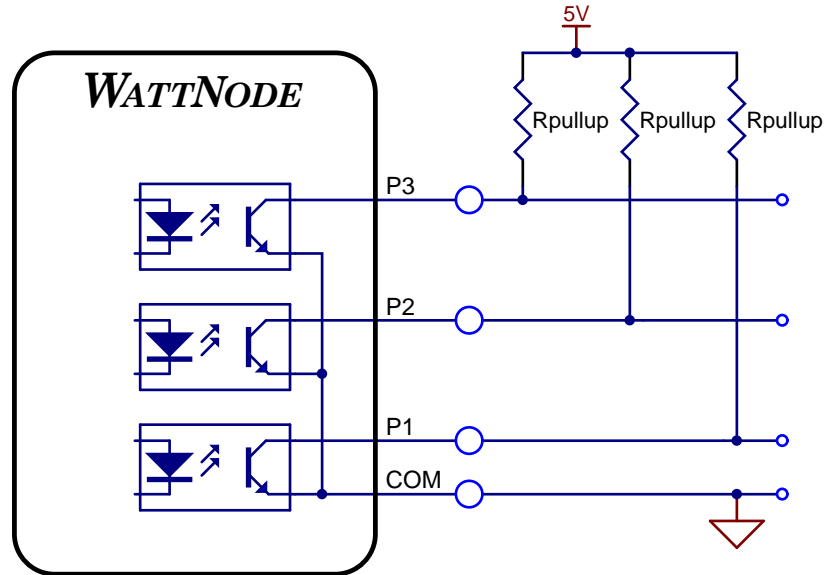

Figure 10: Optoisolator Outputs

The meter can have from one to three pulse output channels. All three output channels share the common **COM** or ground connection. Each output channel has its own positive output connection, labeled **P1**, **P2**, and **P3** (tied to the transistor collectors).

Output Assignments

The following table shows the pulse output channel assignments for the standard bidirectional output model and different options. See [Manual Supplement MS-10](#) for details about **Option PV**, and [Manual Supplement MS-11](#) for details about **Option DPO**.

WattNode Outputs	P1 Output	P2 Output	P3 Output
Standard: Bidirectional Outputs	Positive real energy (all phases)	Negative real energy (all phases)	Not used
Option P3: Per-Phase Outputs	Phase A positive real energy	Phase B positive real energy	Phase C positive real energy
Option PV: Photovoltaic	Phases A+B positive real energy	Phases A+B negative real energy	Phase C positive real energy
Option DPO: Dual Positive Outputs	Positive real energy (all phases)	Negative real energy (all phases)	Positive real energy (all phases)

Table 3: Pulse Output Assignments

Note: we use the terms “positive” and “negative”, but other common terms are “production” and “consumption”. You can wire the meter so that positive energy corresponds to either production or consumption, depending on your application.

Pull-Up Resistor Selection

For standard WattNode meters with the normal 4.00 Hz full-scale frequency, pull-up resistor values between 10kΩ and 100kΩ work well. You may use values of 1.0MΩ or higher to reduce power consumption for battery powered equipment. **Note:** pull-up resistor values of 1.0MΩ or higher will make the pulse output signal more susceptible to interference, so you may want to keep the wiring short, use shielded cable, and avoid running the pulse signal near AC wiring.

The following table lists pull-up resistor values (in ohms, kilo-ohms, and mega-ohms) to use with the pulse output channels, particularly if you have ordered a model with a pulse frequency different than 4.00 Hz. For each configuration, the table lists a recommended value, followed by minimum and maximum resistor values. These values typically result in a pulse waveform rise time (from 20% to 80% of the pull-up voltage) of less than 10% of the total pulse period. The fall time is roughly constant in the 2 to 10 microsecond range. Lower resistance will result in faster switching and increase the current flow. If your frequency isn't in the table, use the next higher frequency or interpolate between two values.

Full-Scale Pulse Frequency	Pull-up to 3.0 Vdc Recommended (Min-Max)	Pull-up to 5.0 Vdc Recommended (Min-Max)	Pull-up to 12 Vdc Recommended (Min-Max)	Pull-up to 24 Vdc Recommended (Min-Max)
1 Hz	470kΩ (600Ω-4.7M)	470kΩ (1.0k-5.6M)	470kΩ (2.4k-7.5M)	1.0MΩ (4.7k-9.1M)
4 Hz	100kΩ (600Ω-1.2M)	100kΩ (1.0k-1.6M)	100kΩ (2.4k-2.2M)	200kΩ (4.7k-3.0M)
10 Hz	47kΩ (600Ω-470k)	47kΩ (1.0k-620k)	47kΩ (2.4k-910k)	100kΩ (4.7k-1.3M)
50 Hz	10kΩ (600Ω-91k)	10kΩ (1.0k-130k)	20kΩ (2.4k-200k)	47kΩ (4.7k-270k)
100 Hz	4.7kΩ (600Ω-47k)	4.7kΩ (1.0k-62k)	10kΩ (2.4k-100k)	20kΩ (4.7k-130k)
200 Hz	2.0kΩ (600Ω-24k)	2.0kΩ (1.0k-33k)	4.7kΩ (2.4k-47k)	10kΩ (4.7k-68k)
600 Hz	2.0kΩ (600Ω-8.2k)	2.0kΩ (1.0k-12k)	4.7kΩ (2.4k-16k)	10kΩ (4.7k-22k)

Table 4: Recommended Pulse Output Pull-up Resistors

When the optoisolator is on (conducting), there is a small voltage drop between the common and output terminals, typically 0.1 - 0.4 volts, called the saturation voltage. This voltage depends on the current flow through the optoisolator (see [Specifications - Optoisolator Outputs \(p. 32\)](#) below for details). To compute the current flow through the optoisolator, use the following approximate equation:

- ***Vpullup*** - The supply voltage for the pull-up resistor (DC volts).
- ***Rpullup*** - The pull-up resistor resistance (ohms).
- ***lopto*** - The approximate current (amps) through the optoisolator when it is on (conducting).

$$I_{opto} = V_{pullup} / R_{pullup}$$

Installation Summary

- 1) Mount the WattNode meter.
- 2) Turn off power before installing solid-core (non-opening) CTs or making voltage connections.
- 3) Mount the CTs around the line voltage conductors being measured. Take care to orient the CTs facing the source of power.
- 4) Connect the twisted white and black wires from the CT to the six position black terminal block on the meter, matching the wire colors to the white and black dots on the front label.
- 5) Connect the voltage wires including ground and neutral (if present) to the green terminal block, and check that the current (CT) phases match the voltage measurement phases.
- 6) Connect the pulse output terminals of the meter to the monitoring equipment.
- 7) Apply power to the meter.
- 8) Verify that the LEDs light correctly and don't indicate an error condition.

Installation LED Diagnostics

The WattNode meter includes multi-color power diagnostic LEDs for each phase to help verify correct operation and diagnose incorrect wiring. The LEDs are marked “Status” on the label. The following diagrams and descriptions explain the various LED patterns and their meanings. The A, B, and C on the left side indicate the phase of the LEDs. Values like “1.0sec” and “3.0sec” indicate the time the LEDs are lit in seconds. In the diagrams, sometimes the colors are abbreviated: R = red, G or Grn = green, Y = yellow.

Normal Startup

On initial power-up, the LEDs will all light up in a red, yellow, green sequence. After this startup sequence, the LEDs will show the status, such as **Normal Operation** below.

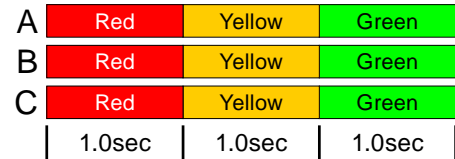

Normal Operation

During normal operation, when positive power is measured on a phase, the LED for that phase will flash green. Typical flash rates are shown below.

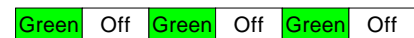

Percent of Full-Scale Power	LED Flash Rate	Flashes in 10 Seconds
100%	5.0 Hz	50
50%	3.6 Hz	36
25%	2.5 Hz	25
10%	1.6 Hz	16
5%	1.1 Hz	11
1% (and lower)	0.5 Hz	5

Table 5: LED Flash Rates vs. Power

Zero Power

For each phase, if line Vac is present, but the measured power is below the minimum that the meter will measure (see **Specifications - Measurement - Creep Limit**), the meter will display solid green for that phase.



Inactive Phase

If the meter detects no power and line voltage below 20% of nominal, it will turn off the LED for the phase.

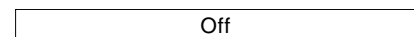

Negative Power

If one or more of the phase LEDs are flashing red, it indicates negative power (power flowing into the grid) on those phases. The rate of flashing indicates magnitude of negative power (see **Table 5** above). This can happen for the following reasons:

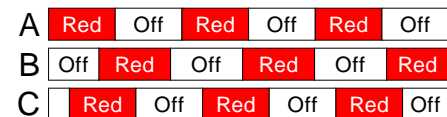

- This is a bidirectional power measurement application, such as a photovoltaic system, where negative power occurs whenever you generate more power than you consume.
- The current transformer (CT) for this phase was installed backwards on the current carrying wire or the white and black wires for the CT were reversed at the meter. This can be solved by flipping the CT on the wire or swapping the white and black wires at the meter.
- In some cases, this can also occur if the CT wires are connected to the wrong inputs, such as if the CT wires for phases B and C are swapped.

Note: if all three LEDs are flashing red and they always turn on and off together, like the diagram for **Low Line Voltage** below, then the meter is experiencing an error or low line voltage, not negative power.

Erratic Flashing

If the LEDs are flashing slowly and erratically, sometimes green, sometimes red, this generally indicates one of the following:

- Earth ground is not connected to the meter (the top connection on the green screw terminal).
- Voltage is connected for a phase, but the current transformer is not connected, or the CT has a loose connection.
- In some cases, particularly for a circuit with no load, this may be due to electrical noise. This is not harmful and can generally be disregarded, provided that you are not seeing substantial measured power when there shouldn't be any. Try turning on the load to see if the erratic flashing stops.

To fix this, try the following:

- Make sure earth ground is connected.
- If there are unused current transformer inputs, install a shorting jumper for each unused CT (a short length of wire connected between the white and black dots marked on the label).
- If there are unused voltage inputs (on the green screw terminal), connect them to neutral (if present) or earth ground (if neutral isn't available).
- If you suspect noise may be the problem, try moving the meter away from the source of noise. Also try to keep the CT wires as short as possible and cut off excess wire.



Meter Not Operating

It should not be possible for all three LEDs to stay off when the meter is powered, because the phase powering the meter will have line voltage present. Therefore, if all LEDs are off, the meter is either not receiving sufficient line voltage to operate, or is malfunctioning and needs to be returned for service. Verify that the voltage on the Vac screw terminals is within $\pm 20\%$ of the nominal operating voltages printed in the white rectangle on the front label.

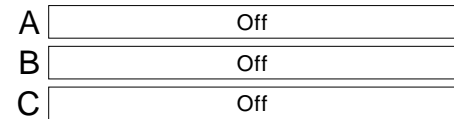

Meter Error

If the meter experiences an internal error, it will light all LEDs red for three seconds (or longer). If you see this happen repeatedly, return the meter for service.

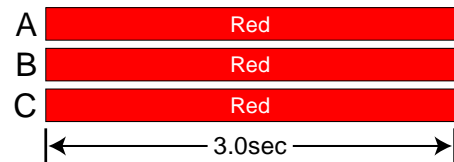

Bad Calibration

This indicates that the meter has detected bad calibration data and must be returned for service.

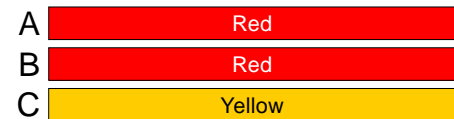

Line Voltage Too High

Whenever the meter detects line voltages over 125% of normal for one or more phases, it will display a fast red/green flashing for the affected phases. This is harmless if it occurs due a momentary surge, but if the line voltage is high continuously, **the power supply may fail. If you see continuous over-voltage flashing, disconnect the meter immediately!** Check that the model and voltage rating is correct for the electrical service.

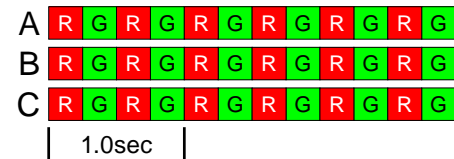

Bad Line Frequency

If the meter detects a power line frequency below 45 Hz or above 70 Hz, it will light all the LEDs yellow for at least three seconds. The LEDs will stay yellow until the line frequency returns to normal. During this time, the meter should continue to accurately measure power. This can occur in the presence of extremely high noise, such as if the meter is too close to an unfiltered variable frequency drive.

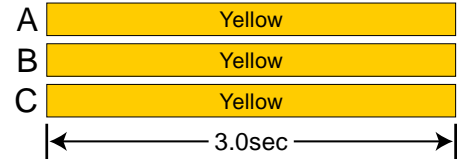

Low Line Voltage

These LED patterns occur if the line voltage is too low for the meter to operate correctly and the meter reboots repeatedly. The pattern will be synchronized on all three LEDs. Verify that the voltage on the Vac screw terminals is not more than 20% lower than the nominal operating voltages printed in the white rectangle on the front label. If the voltages are in the normal range and the meter continues to display one of these patterns, return it for service.

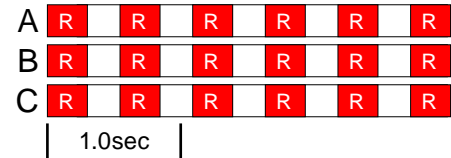
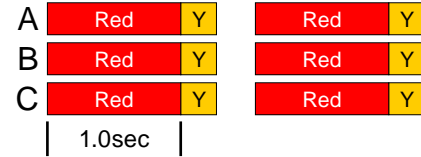

Measurement Troubleshooting

If the WattNode meter does not appear to be operating correctly or generating expected pulses, start by checking the diagnostic LEDs as described in the previous section [Installation LED Diagnostics \(p. 20\)](#). Then double check the installation instructions. If there are still problems, check the following.

No Pulses

- Make sure the load is turned on.
- If the LEDs are flashing green, then the meter is measuring positive power and should output pulses on **P1**, so there may be something wrong with the pulse output connection or you may need a pull-up resistor; see [Connecting Pulse Outputs \(p. 17\)](#).
- If the LEDs on one or more phases are flashing red, then the total power may be negative, in which case the meter won't generate positive energy pulses. If you have a bidirectional model, you can check for negative energy pulses on the **P2** output. If this is the case, check that the line phases match the CT phases, that all the CTs face the source of power, and that the CT white and black wires are connected correctly.
- If all the LEDs are solid green (or off), then the measured power is below the creep limit (1/1500th of full-scale) and the meter will not generate any pulses. See [Specifications - Creep Limit \(p. 32\)](#).
- If the LEDs are flashing green slowly, the power may be very low. A WattNode meter with a nominal output frequency of 4.00 Hz can have a pulse period of several minutes at very low power levels.
- If all the LEDs are off, then the meter does not have sufficient line voltage to operate, or has malfunctioned. Use a DMM (multimeter) to verify that the voltage on the Vac screw terminals is within -20%, +15% of the nominal operating voltage.

Incorrect Power or Energy Readings.

This can be caused by any of the following:

- An incorrect estimate of expected power or energy readings. If possible, try to verify the actual energy, power, or current with a handheld power meter or current clamp.

- Incorrect scale factors to convert from pulses to energy and power. This is commonly caused by using the normal scale factors with an **Option P3** meter or selecting the wrong row of column from the tables.
- Some pulse counting equipment (data loggers, etc.) counts both rising and falling edges as pulses, resulting in a count that is double the intended value. This can normally be corrected by reconfiguring the device or dividing the scale factor by 2.0.
- Some pulse monitoring devices cannot handle fast pulse rates. If the pulses occur too close together, some may be missed by the monitoring device. Check the specifications of your monitoring device or contact CCS support for assistance.
- The CTs are not installed on the correct line phases. Verify that the CT phasing matches the line Vac inputs.
- The measured current exceeds the CT rating. This can saturate CT or the WattNode meter input circuitry, resulting in lower than expected readings. If possible, use a current clamp to measure the current and make sure it is below the CT rated amps.
- The measured current is too small. Most current transformers are only specified to meet their accuracy from 10% to 100% of rated current. In practice, most CTs work reasonably well down to 1% of rated current. Very low currents may not register properly, resulting in low power or no power reported.
- Interference from a variable frequency or variable speed drive: VFD, VSD, inverter, or the like. Generally, these drives should not interfere with the meter, but if they are in very close proximity, or if the CT leads are long, interference can occur. Try moving the meter at least three feet (one meter) away from any VFDs. Use short CT leads if possible. **NEVER** connect the meter downstream of a VFD: the varying line frequency and extreme noise will cause problems!
- The CTs may be malfunctioning. If possible, use a current clamp to verify the current, then use a DMM (multimeter) to measure the AC voltage between the white and black wires from the CT (leave them connected to the meter during this test). At rated current, the CT output voltage should equal 0.333 Vac (333 millivolts AC). At lower currents, the voltage should scale linearly, so at 20% of rated current, the output voltage should be $0.20 * 0.333 = 0.0666$ Vac (66.6 millivolts AC).
- The meter is not functioning correctly: if possible, swap the meter for another unit of the same model.

Operating Instructions

Pulse Outputs

The WattNode meter generates pulse outputs using one or more optoisolators (also called photocouplers). These provide 5000 Vac of isolation using an LED and a photo-transistor. This allows the meter to be interfaced to monitoring or data logging hardware without concerns about interference, ground loops, shock hazard, etc.

Depending on the options selected, the Pulse WattNode meter can generate full-scale pulses at output frequencies ranging from less than 1 Hz to 600 Hz. The standard full-scale pulse output frequency is 4.00 Hz. The standard model provides two pulse streams for measuring bidirectional power. With **Option P3**, there are three pulse channels for independently measuring each phase or three single-phase circuits.

The pulse outputs are approximately square-waves, with equal on and off periods. The frequency of pulses is proportional to the measured power. When the measured power is constant, the pulse frequency is constant and the output is an exact square-wave. If the power is increasing or decreasing, the output waveform will not be a perfect square-wave as the on and off periods are getting longer or shorter. If you need a fixed or minimum pulse duration (closed period), see [Manual Supplement MS-17: Option PW \(Pulse Width\)](#).

We define a “pulse” as a full cycle including both an Open → Closed and an Closed → Open transition. You can choose either a rising or falling edge to start a pulse; the end of the pulse will be the next matching edge. Some monitoring equipment or data loggers can be configured to count **both** rising and falling edges: if your equipment is configured this way, you will count twice as many pulses as expected. This can normally be corrected by reconfiguring the equipment or adjusting the scale factors by a factor of 2.

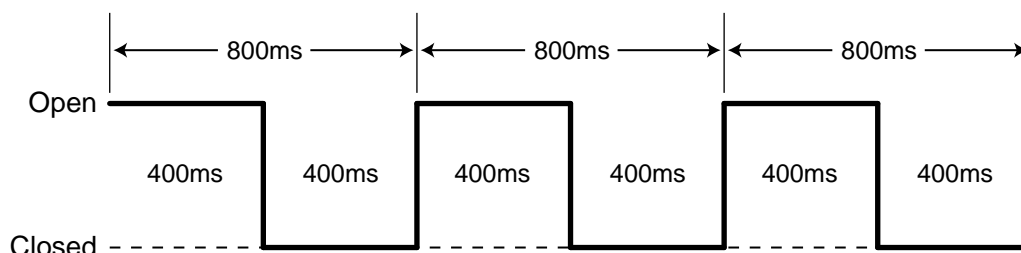

Figure 11: Output Pulses for Steady Power

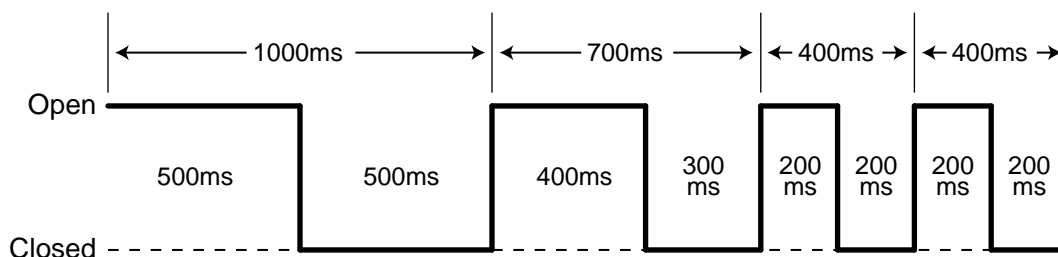

Figure 12: Output Pulses for Increasing Power

See [Connecting Pulse Outputs \(p. 17\)](#) and [Specifications - Pulse Outputs \(p. 32\)](#) for more information.

Power and Energy Computation

Every pulse from the meter corresponds to a fixed amount of energy. Power (watts) is energy divided by time, which can be measured as pulses per second (or pulses per hour). The following scale factor tables and equations convert from pulses to energy (watt-hours or kilowatt-hours) for different models.

If you have ordered a custom full-scale pulse output frequency, then see the **Power and Energy Equations** section below. For **Option PV (Photovoltaic)**, see [Manual Supplement MS-10: Option PV](#) for scale factors.

Scale Factors - Standard Bidirectional Outputs (and Option DPO)

The following table provides scale factors for standard bidirectional output models with a full-scale pulse output frequency of 4.00 Hz. This table also works for 4.00 Hz models with **Option DPO**. Equations to compute power and energy follow the scale factor tables.

CT Size (amps)	Watt-hours per pulse (<i>WHpP</i>)				Pulses Per kilowatt-hour (<i>PpKWH</i>)			
	3Y-208 3D-240	3Y-400 3D-400	3Y-480 3D-480	3Y-600	3Y-208 3D-240	3Y-400 3D-400	3Y-480 3D-480	3Y-600
5	0.125	0.2396	0.2885	0.3615	8000.00	4173.91	3465.70	2766.57
15	0.375	0.7188	0.8656	1.0844	2666.67	1391.30	1155.24	922.190
20	0.500	0.9583	1.1542	1.4458	2000.00	1043.48	866.426	691.643
30	0.750	1.4375	1.7313	2.1688	1333.33	695.652	577.617	461.095
50	1.250	2.3958	2.8854	3.6146	800.000	417.391	346.570	276.657
60	1.500	2.8750	3.4625	4.3375	666.667	347.826	288.809	230.548
70	1.750	3.3542	4.0396	5.0604	571.429	298.137	247.550	197.612
100	2.500	4.7917	5.7708	7.2292	400.000	208.696	173.285	138.329
150	3.750	7.1875	8.6563	10.844	266.667	139.130	115.523	92.219
200	5.000	9.5833	11.542	14.458	200.000	104.348	86.643	69.164
250	6.250	11.979	14.427	18.073	160.000	83.478	69.314	55.331
300	7.500	14.375	17.313	21.688	133.333	69.565	57.762	46.110
400	10.000	19.167	23.083	28.917	100.000	52.174	43.321	34.582
600	15.000	28.750	34.625	43.375	66.667	34.783	28.881	23.055
800	20.000	38.333	46.167	57.833	50.000	26.087	21.661	17.291
1000	25.000	47.917	57.708	72.292	40.000	20.870	17.329	13.833
1200	30.000	57.500	69.250	86.750	33.333	17.391	14.440	11.527
1500	37.500	71.875	86.563	108.44	26.667	13.913	11.552	9.2219
2000	50.000	95.833	115.42	144.58	20.000	10.435	8.6643	6.9164
3000	75.000	143.75	173.13	216.88	13.333	6.9565	5.7762	4.6110
any	<u>CtAmps</u> 40	<u>CtAmps</u> 20.87	<u>CtAmps</u> 17.329	<u>CtAmps</u> 13.833	<u>40,000</u> <u>CtAmps</u>	<u>20,870</u> <u>CtAmps</u>	<u>17,329</u> <u>CtAmps</u>	<u>13,833</u> <u>CtAmps</u>

Table 6: Scale Factors - Bidirectional Outputs

Contact CCS for scale factors for models with full-scale pulse output frequencies other than 4.00 Hz.

Scale Factors - Option P3: Per-Phase Outputs

The following table provides scale factors for **Option P3** models with a full-scale pulse output frequencies of 4.00 Hz for each phase. Note: with **Option P3**, different phases can use different CTs with different rated currents.

WARNING: Only use this table if you have Option P3 (Per-Phase Outputs)!

CT Size (amps)	Watt-hours per pulse (<i>WHpP</i>)				Pulses Per kilowatt-hour (<i>PpKWH</i>)			
	3Y-208 3D-240	3Y-400 3D-400	3Y-480 3D-480	3Y-600	3Y-208 3D-240	3Y-400 3D-400	3Y-480 3D-480	3Y-600
5	0.04167	0.07986	0.09618	0.12049	24000.0	12521.7	10397.1	8299.71
15	0.1250	0.2396	0.2885	0.3615	8000.00	4173.91	3465.70	2766.57
20	0.1667	0.3194	0.3847	0.4819	6000.00	3130.43	2599.28	2074.93
30	0.2500	0.4792	0.5771	0.7229	4000.00	2086.96	1732.85	1383.29
50	0.4167	0.7986	0.9618	1.2049	2400.00	1252.17	1039.71	829.971
60	0.5000	0.9583	1.1542	1.4458	2000.00	1043.48	866.426	691.643
70	0.5833	1.1181	1.3465	1.6868	1714.29	894.410	742.651	592.837
100	0.8333	1.5972	1.9236	2.4097	1200.00	626.087	519.856	414.986
150	1.2500	2.3958	2.8854	3.6146	800.000	417.391	346.570	276.657
200	1.6667	3.1944	3.8472	4.8194	600.000	313.043	259.928	207.493
250	2.0833	3.9931	4.8090	6.0243	480.000	250.435	207.942	165.994
300	2.5000	4.7917	5.7708	7.2292	400.000	208.696	173.285	138.329
400	3.3333	6.3889	7.6944	9.6389	300.000	156.522	129.964	103.746
600	5.0000	9.5833	11.542	14.458	200.000	104.348	86.643	69.164
800	6.6667	12.778	15.389	19.278	150.000	78.261	64.982	51.873
1000	8.3333	15.972	19.236	24.097	120.000	62.609	51.986	41.499
1200	10.000	19.167	23.083	28.917	100.000	52.174	43.321	34.582
1500	12.500	23.958	28.854	36.146	80.000	41.739	34.657	27.666
2000	16.667	31.944	38.472	48.194	60.000	31.304	25.993	20.749
3000	25.000	47.917	57.708	72.292	40.000	20.870	17.329	13.833
any	<u>CtAmps</u> 120.00	<u>CtAmps</u> 62.609	<u>CtAmps</u> 51.986	<u>CtAmps</u> 41.499	<u>120.000</u> <u>CtAmps</u>	<u>62.609</u> <u>CtAmps</u>	<u>51.986</u> <u>CtAmps</u>	<u>41.499</u> <u>CtAmps</u>

Table 7: Scale Factors - Per-Phase Outputs (*Option P3*)

Scale Factor Equations

Using the “Watt-hours per pulse” *WHpP* value from the table above for your model and current transformer, you can compute energy and power as follows:

- **PulseCount** - This is the count of pulses, used to compute energy. You can use the count of pulses over specified periods of time (like a month) to measure the energy for that period of time.
- **PulseFreq** - This is the measured pulse frequency (Hertz) out of the meter. This can also be computed by counting the number of pulses in a fixed period of time and then dividing by the number of seconds in that time period. For example, if you count 720 pulses in five minutes (300 seconds), then **PulseFreq** = 720 / 300 = 2.40 Hz.

$$\text{Energy (watt-hours)} = \text{WHpP} \cdot \text{PulseCount}$$

$$\text{Power (watts)} = \text{WHpP} \cdot 3600 \cdot \text{PulseFreq}$$

To convert these values to kilowatt-hours and kilowatts, divide by 1000.

Using the “Pulses Per kilowatt-hour” **PpKWH** value from the table above for your model and current transformer, you can compute energy and power as follows (multiply by 1000 to convert kilowatts to watts):

$$\text{Energy (kilowatt-hours)} = \text{PulseCount} / \text{PpKWH}$$

$$\text{Power (kilowatts)} = 3600 \cdot \text{PulseFreq} / \text{PpKWH}$$

Power and Energy Equations

This section shows how to compute power and energy from pulses for any full-scale pulse output frequency. The power is proportional to the pulse frequency, while the energy is proportional to the count of pulses.

For these calculations, we use the following variables:

- **NVac** - This is the **nominal** line voltage (phase to neutral) of the WattNode model. For delta model, this is a virtual voltage, since there may not be a neutral connection. Note: this is **not** the actual measured voltage.
- **PpPO** - “Phases per Pulse Output”. This is the number of meter voltage phases associated with a pulse output channel. This may be different than the number of phases you are monitoring.
 - **Standard** and **Option DPO** (Dual Positive Outputs): **PpPO** = 3
 - **Option P3** (Per-Phase Outputs): **PpPO** = 1
 - **Option PV** (Photovoltaic): **PpPO** = 2 for outputs **P1** and **P2**, **PpPO** = 1 for output **P3**
- **CtAmps** - This is the current transformer (CT) rated amps. Note: If the conductors being measured are passed through the CTs more than once, then **CtAmps** is the rated CT current divided by the number of times that the conductor passes through the CT.
- **FSHz** - This is the full-scale pulse frequency of the meter. It is 4.00 Hz, unless the meter was ordered with **Option Hz=xxx** (where **xxx** specifies the full-scale pulse frequency) or **Option Kh**.
- **PulseCount** - This is the measured pulse count, used to compute energy. You can use the count of pulses over specified periods of time (such as a month) to measure the energy for that period of time.
- **PulseFreq** - This is the measured pulse frequency from one of the pulse channels (**P1**, **P2**, or **P3**). This can be computed by counting the number of pulses in a fixed period of time and then dividing by the number of seconds in that time period. For example, if you count 720 pulses in five minutes (300 seconds), then **PulseFreq** = 720 / 300 = 2.40 Hz.

The values of the constant parameters are in the following table.

WattNode Models	NVac	Standard FSHz Values
WNB-3Y-208-P	120	4.00 Hz
WNB-3Y-400-P	230	4.00 Hz
WNB-3Y-480-P	277	4.00 Hz
WNB-3Y-600-P	347	4.00 Hz
WNB-3D-240-P	120*	4.00 Hz
WNB-3D-400-P	230*	4.00 Hz
WNB-3D-480-P	277*	4.00 Hz

*Note: these are “virtual” line-to-neutral voltages used for delta model power and energy computations.

Table 8: Power and Energy Parameters

Watt-Hours per Pulse

$$WHpP = \frac{PpPO \cdot NVac \cdot CtAmps}{FSHz \cdot 3600}$$

Watt-Hours per Pulse per CT Rated Amp

There is an alternate way of computing the energy reported by a meter using the variable **WHpPpA** (watt-hours per pulse per CT rated amp). If you multiply the **WHpPpA** by the amp rating of your CTs, the result will be the watt-hours measured each time the meter generates a pulse.

$$EnergyPerPulse (WH) = WHpPpA \cdot CtAmps$$

The standard **WHpPpA** values are listed in the following table. These only apply for models with a 4.00 Hz full-scale pulse frequency.

WattNode Models	Watt-Hours per Pulse per CT Rated Amp (FSHz = 4.00)	
	Standard and Option DPO Outputs	Option P3: Per-Phase Outputs
WNB-3Y-208-P	0.02500	0.008333
WNB-3Y-400-P	0.04792	0.01597
WNB-3Y-480-P	0.05771	0.01924
WNB-3Y-600-P	0.07229	0.02410
WNB-3D-240-P	0.02500	0.008333
WNB-3D-400-P	0.04792	0.01597
WNB-3D-480-P	0.05771	0.01924

Table 9: Watt-Hours per Pulse per CT Rated Amp

For example: a WNB-3Y-208-P with a full-scale pulse frequency of 4.00 Hz has a **WHpPpA** value of 0.0250. With 15 amp CTs, it will output one pulse for every 0.375 watt-hours.

$$(0.025) \cdot (15.0 \text{ amps}) = 0.375 \text{ watt-hours}$$

It is easy to use the **WHpPpA** value to compute energy:

$$Energy (Wh) = WHpPpA \cdot CtAmps \cdot PulseCount$$

For non-standard models, you can compute **WHpPpA** as follows:

$$WHpPpA = \frac{PpPO \cdot NVac}{FSHz \cdot 3600}$$

Energy Equation

The following equation computes the energy (watt-hours) associated with a pulse output channel. By using the **PulseCount** for different periods of time (day, week, month, etc.), you can measure the energy over different time periods. You can convert this to kilowatt-hours by dividing by 1000. The 3600 term in the denominator converts from watt-seconds to watt-hours. Note: use **NVac** value from [Table 8](#) above.

$$Energy (WH) = \frac{NVac \cdot PpPO \cdot CtAmps \cdot PulseCount}{FSHz \cdot 3600}$$

Pulses per Watt-Hour

$$PpWH = \frac{FSHz \cdot 3600}{NVac \cdot PpPO \cdot CtAmps}$$

Pulses Per Kilowatt-Hour

$$PpKWH = \frac{FSHz \cdot 3600 \cdot 1000}{NVac \cdot PpPO \cdot CtAmps}$$

Full-Scale Power Equation

The following equation computes the nominal full-scale power associated with a pulse output channel. For bidirectional output models, this is the full-scale power for all phases together. For per-phase output models, this is the full-scale power for a single phase. Note: use **NVac** value from **Table 8: Power and Energy Parameters** above.

$$Full\text{-Scale Power (W)} = NVac \cdot PpPO \cdot CtAmps$$

Power Equation

The following equation computes the power associated with a pulse output. The **PulseFreq** value may be measured or averaged over different time periods to compute the average power (also called demand). Note: use **NVac** value from **Table 8** above.

$$Power (W) = \frac{NVac \cdot PpPO \cdot CtAmps \cdot PulseFreq}{FSHz}$$

Maintenance and Repair

The WattNode Pulse meter requires no maintenance. There are no user serviceable or replaceable parts except the pluggable screw terminals.

The WattNode meter should not normally need to be cleaned, but if cleaning is desired, power must be disconnected first and a dry or damp cloth or brush should be used.

The WattNode meter is not user serviceable. In the event of any failure, the meter must be returned for service (contact CCS for an RMA). In the case of a new installation, follow the diagnostic and troubleshooting instructions before returning the meter for service, to ensure that the problem is not connection related.

Specifications

Models

Model	Nominal Vac Line-to-Neutral	Nominal Vac Line-to-Line	Phases	Wires
WNB-3Y-208-P	120	208–240	3	4
WNB-3Y-400-P	230	400	3	4
WNB-3Y-480-P	277	480	3	4
WNB-3Y-600-P	347	600	3	4
WNB-3D-240-P	120*	208–240	3	3–4
WNB-3D-400-P	230*	400	3	3–4
WNB-3D-480-P	277*	480	3	3–4

*Note: the delta models have an optional neutral connection that may be used for measuring wye circuits. In the absence of neutral, voltages are measured with respect to ground. Delta WattNode models use the phase A and phase B connections for power.

Table 10: WattNode Models

Model Options

Any of these models are available with the following options:

- **Bidirectional Outputs** - (*this is the standard model*) This model has two pulse output channels. **P1** generates pulses in proportion to the total real positive energy, while **P2** generates pulses in proportion to the total real negative energy. The individual phase energies are all added together every 200 ms. If the result is positive, it is accumulated for the **P1** output; if negative, it is accumulated for the **P2** output. If one phase has negative power (-100 W), while the other two phases have positive power (+100 W each), the negative phase will subtract from the positive phases, resulting in a net of 100 W, causing pulses on **P1**, but no pulses on **P2**. There will only be pulses on **P2** if the sum of all three phases is negative.
- **Option P3: Per-Phase Outputs** - Models with this option have three pulse output channels: **P1**, **P2**, and **P3**. Each generates pulses in proportion to the real positive energy measured on one phase (phases A, B, and C respectively).
- **Option DPO: Dual Positive Outputs** - This option is like the standard model with bidirectional outputs, but with the addition of the **P3** output channel. The **P3** channel indicates positive real energy, just like the **P1** channel. This is useful when the meter needs to be connected to two different devices, such as a display and a data logger. See [Manual Supplement MS-11: Option DPO \(Dual Positive Outputs\)](#) for details.
- **Option PV: Photovoltaic** - The photovoltaic option measures residential PV systems. It allows one WattNode meter to measure the bidirectional total house energy, and the PV (or wind) generated energy. See [Manual Supplement MS-10: Option PV \(Photovoltaic\)](#) for details.
- **Option Hz: Custom Pulse Output Frequency** - WattNode meters are available with custom full-scale pulse output frequencies ranging from 0.01 Hz to 600 Hz (150 Hz maximum for **Options P3, DPO, and PV**). For custom frequencies, specify **Option Hz=nnn**, where **nnn** is the desired full-scale frequency. To specify different frequencies for **P1, P2, and P3**, use **Option Hz=rrr/sss/ttt**, where **P1** frequency = **rrr**, **P2** frequency = **sss**, **P3** frequency = **ttt**.
- **Option SSR: Solid State Relay Output** - Replaces the standard optoisolator outputs with solid state relays capable of switching 500 mA at up to 40 Vac or ± 60 Vdc. See [Option SSR Outputs](#) below for details.
- **Option TVS=24** - Install 24 V bidirectional TVS protection diodes across P1, P2, and P3 outputs. Used with **Option SSR** when driving 12 Vdc electromechanical counters to protect the solid-state relays from the inductive kickback of the counter.

- **Option PW: Pulse Width** - This specifies the pulse **ON** (closed or conducting) period in milliseconds. For example, **Opt PW=100** configures 100 millisecond pulse **ON** periods. See [Manual Supplement MS-17: Option PW \(Pulse Width\)](#) for details.
- **Option Kh: Watt-hour Constant** - This specifies the watt-hour constant, or the number of watt-hours that must accumulate for each pulse generated by the meter. Each pulse includes an **ON** (conducting) and **OFF** period. The number of watt-hours may be small, even less than one, or large. For example, **Opt Kh=1000** specifies one pulse per 1000 watt-hours (one pulse per kilowatt-hour). See http://www.ccontrols.com/w/Option_Kh.
- **Option CT: Current Transformer Rated Amps** - This specifies the rated amps of the attached current transformers. This is only used in conjunction with **Option Kh**. It may be specified as **Opt CT=xxx** or **Opt CT=xxx/yyy/zzz** if there are CTs with different rated amps on different phases. See http://www.ccontrols.com/w/WattNode_Pulse_-_Option_CT_-_CT_Rated_Amps.

Accuracy

The following accuracy specifications do not include errors caused by the current transformer accuracy or phase angle errors. "Rated current" is the current that generates a CT output voltage of 0.33333 Vac.

Condition 1 - Normal Operation

Line voltage: -20% to +15% of nominal

Power factor: 1.0

Frequency: 48 - 62 Hz

Ambient Temperature: 25°C

CT Current: 5% - 100% of rated current

Accuracy: ±0.5% of reading

Condition 2 - Low CT Current

All conditions the same as Condition 1 except:

CT Current: 1% - 5% of rated current

Accuracy: ±1.0% of reading

Condition 3 - Very Low CT Current

All conditions the same as Condition 1 except:

CT Current: 0.2% - 1% of rated current

Accuracy: ±3.0% of reading

Condition 4 - High CT Current

All conditions the same as Condition 1 except:

CT Current: 100% - 120% of rated current

Accuracy: ±1.0% of reading

Condition 5 - Low Power Factor

All conditions the same as Condition 1 except:

Power factor: 0.5 (±60 degree phase shift between current and voltage)

Additional Error: ±0.5% of reading

Condition 6 - Temperature Variation

All conditions the same as Condition 1 except:

Ambient Temperature: -30°C to +55°C

Additional Error: ±0.75% of reading

*Note: **Option PV** WattNode models may not meet these accuracy specifications for the **P3** output channel when measuring a two-phase inverter or multiple inverters.*

Measurement

Creep Limit: 0.067% (1/1500th) of full-scale. Whenever the apparent power (a combination of the real and reactive power values) for a phase drops below the creep limit, the output power (real) for the phase will be forced to zero. Also, if the line voltage for a phase drops below 20% of nominal Vac, the output power for the phase will be set to zero. These limits prevent spurious pulses due to measurement noise.

Update Rate: ~200 milliseconds. Internally, the consumed energy is measured at this rate and used to update the pulse output rate.

Start-Up Time: approximately 500 milliseconds. The meter starts measuring power and generating pulses 500 milliseconds after AC voltage is applied

Current Transformer Phase Angle Correction: 1.0 degree leading. Current transformers (CTs) typically have a leading phase angle error ranging from 0.2 degrees to 2.5 degrees. The WattNode meter is normally programmed to correct for a 1.0 degree phase lead to provide good accuracy with typical CTs.

Over-Voltage Limit: 125% of nominal Vac. If the line voltage for one or more phases exceeds this limit, the status LEDs for these phases will flash alternating red-green as a warning. Extended over-voltage operation can damage the meter and void the warranty. See [Line Voltage Too High \(p. 21\)](#).

Over-Current Limit: 120% of rated current. Exceeding 120% of rated current will not harm the WattNode meter but the current and power will not be measured accurately.

Pulse Outputs

Factory Programmable Full-Scale Pulse Frequencies:

Standard (All Models): 4.00 Hz

Custom (Bidirectional Output Models): 0.01 Hz to 600 Hz

Custom (Option P3, Option PV, Option DPO): 0.01 Hz to 150 Hz

Absolute Maximum Pulse Output Frequencies:

Standard Models (Bidirectional Outputs): 900 Hz

Option P3, Option PV, Option DPO: 200 Hz

Output Waveform: square-wave, ~50% duty cycle

Option PW: programmable pulse **ON** (closed or conducting period, 1 to 65535 milliseconds)

Optoisolator Outputs:

Isolation: 5000 Vac RMS

Breakdown Voltage (collector–emitter): 60 V (exceeding this may destroy the outputs)

Maximum Reverse Voltage (emitter–collector): 5 Vdc (exceeding may destroy the outputs)

Maximum Leakage (OFF) Current (collector–emitter): 100 nA

Recommended Load Current (collector–emitter): 1 μ A (microamp) to 5 mA (milliamp)

Maximum Load (collector–emitter) Current: ~8 mA

Approximate ON Resistance (as measured by a DMM): 100 Ω to 2000 Ω

Approximate OFF Resistance (as measured by a DMM): > 50 M Ω

Saturation Voltage vs. Load Current: this is the typical voltage (at room temperature) measured between the **COM** terminal and **P1**, **P2**, or **P3** when the optoisolator is on (conducting). Ideally, this voltage would be zero, but instead, it varies with the load current.

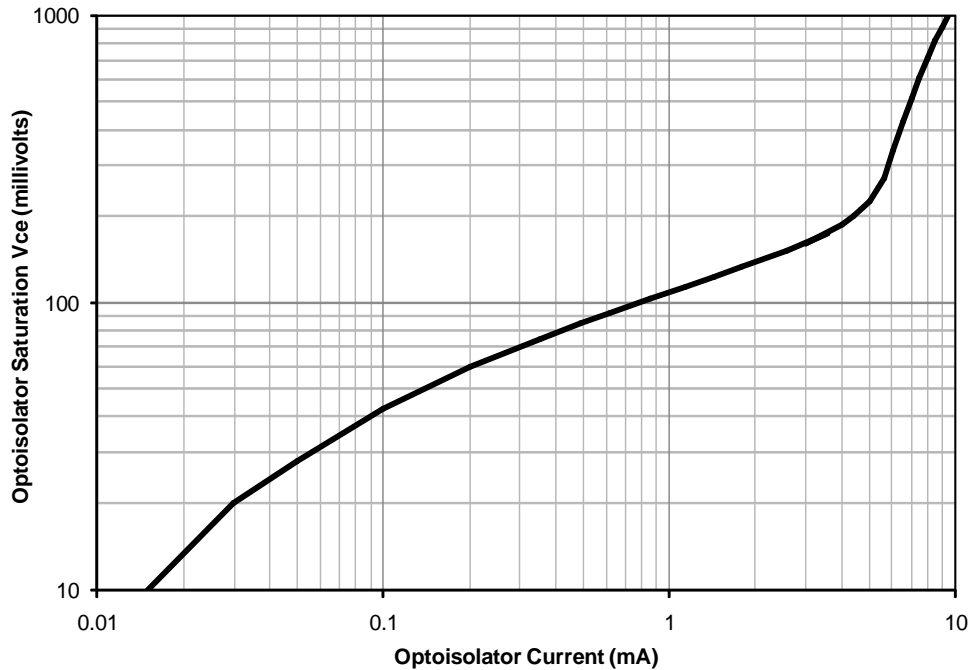

Figure 13: Optoisolator Saturation Voltage vs. Load Current

Output Rise Time (microseconds): approximately $R_{pullup} / 100$, where R_{pullup} is the pull-up resistor value (in ohms) and the pull-up voltage is 5 Vdc. Rise time is defined as the time for the output voltage to rise from 20% to 80% of the pull-up voltage.

Output Fall Time: approximately 2-3 microseconds with a 5 Vdc pull-up voltage.

Option SSR Outputs:

Isolation: 5000 Vac RMS

Breakdown Voltage: ± 60 Vdc or 40 Vac; can switch positive, negative or AC voltages

Maximum Leakage (Off) Current: 1000 nA (1 μ A)

On Resistance: 1.0 to 2.5 Ω

Maximum Load Current: 500 mA

Output Turn On Time (milliseconds): 1.8 ms typical, 5.0 ms maximum

Output Turn Off Time (milliseconds): 0.5 ms typical, 2.0 ms maximum

Maximum Recommended Pulse Frequency: 30 Hz

Electrical

Power Consumption: The following table shows typical power consumption and power factor values with all three phases powered at nominal line voltages. The power supply draws most of the total power consumed, while the measurement circuitry draws 1-10% of the total (6-96 milliwatts per phase, depending on the model). Due to the design of the power supply, WattNode meters draw slightly more power at 50 Hz.

Model	Active Power at 60 Hz	Active Power at 50 Hz	Power Factor	Rated Power*	Power Supply Range	Power Supply Terminals
WNB-3Y-208-P	1.6 W	1.8 W	0.75	3 W	96 – 138 Vac	N and ΦA
WNB-3Y-400-P	1.6 W	1.8 W	0.64	3 W	184 – 264 Vac	N and ΦA
WNB-3Y-480-P	2.1 W	2.4 W	0.63	4 W	222 – 318 Vac	N and ΦA
WNB-3Y-600-P	1.2 W	1.2 W	0.47	3 W	278 – 399 Vac	N and ΦA
WNB-3D-240-P	1.7 W	1.9 W	0.63	4 W	166 – 276 Vac	ΦA and ΦB
WNB-3D-400-P	1.4 W	1.5 W	0.47	3 W	320 – 460 Vac	ΦA and ΦB
WNB-3D-480-P	1.8 W	2.2 W	0.53	4 W	384 – 552 Vac	ΦA and ΦB

Table 11: Power Supply Characteristics

**Note: This is the maximum rated power at 115% of nominal Vac at 50 Hz. This is the same as the rated power that appears on the front label of the meter.*

Maximum Operating Power Supply Voltage Range: -20% to +15% of nominal (see table above). For the WNB-3D-240-P, this is -20% of 208 Vac (166 Vac) to +15% of 240 Vac (276 Vac).

Operating Frequencies: 50/60 Hz

Measurement Category: CAT III

Measurement category III is for measurements performed in the building installation. Examples are measurements on distribution boards, circuit-breakers, wiring, including cables, bus-bars, junction boxes, switches, socket-outlets in the fixed installation, and equipment for industrial use and some other equipment, for example, stationary motors with permanent connection to the fixed installation.

The line voltage measurement terminals on the meter are rated for the following CAT III voltages (these ratings also appear on the front label):

Model	CAT III Voltage Rating
WNB-3Y-208-P WNB-3D-240-P	240 Vac
WNB-3Y-400-P WNB-3D-400-P	400 Vac
WNB-3Y-480-P WNB-3D-480-P	480 Vac
WNB-3Y-600-P	600 Vac

Table 12: WattNode CAT III Ratings

Current Transformer Inputs:

Nominal Input Voltage (At CT Rated Current): 0.33333 Vac RMS

Absolute Maximum Input Voltage: 5.0 Vac RMS

Input Impedance at 50/60 Hz: 23 kΩ

Certifications

Safety: UL 61010-1; CAN/CSA-C22.2 No. 61010-1-04; IEC 61010-1

Immunity: EN 61326: 2002 (Industrial Locations)

Electrostatic Discharge: EN 61000-4-2: 4 kV contact, 8 kV air: (B) Self-Recovering

Radiated RF Immunity: EN 61000-4-3: 10 V/m: (A) No Degradation

Electrical Fast Transient / Burst: EN 61000-4-4: 2 kV: (B) Self-Recovering

Surge Immunity: EN 61000-4-5: 1 kV I/O, 4 kV AC: (B) Self-Recovering

Conducted RF Immunity: EN 61000-4-6: 3 V: (A) No Degradation

Voltage Dips, Interrupts: EN 61000-4-11: (B) Self-Recovering

Emissions: FCC Part 15, Class B; EN 55022: 1994, Class B

Environmental

Operating Temperature: -30°C to +55°C (-22°F to 131°F)

Altitude: Up to 2000 m (6560 ft)

Operating Humidity: non-condensing, 5 to 90% relative humidity (RH) up to 40°C, decreasing linearly to 50% RH at 55°C.

Pollution: POLLUTION DEGREE 2 - Normally only non-conductive pollution; occasionally, a temporary conductivity caused by condensation must be expected.

Indoor Use: Suitable for indoor use.

Outdoor Use: Suitable for outdoor use when mounted inside an electrical enclosure (Hammond Mfg., Type EJ Series) that is rated NEMA 3R or 4 (IP 66).

Mechanical

Enclosure: High impact, ABS and/or ABS/PC plastic

Flame Resistance Rating: UL 94V-0, IEC FV-0

Size: 153 mm × 85 mm × 38 mm (6.02 in × 3.35 in × 1.50 in)

Weight: 285 gm (10.1 oz) 314 gm (11.1 oz)

Connectors: Euroblock style pluggable terminal blocks

Green: up to 12 AWG (2.5 mm²), 600 V

Black: up to 12 AWG (2.5 mm²), 300 V

Current Transformers

WattNode meters use CTs with built-in burden resistors generating 0.33333 Vac at rated AC current. The maximum input current rating is dependent on the CT frame size (see the tables below). Exceeding the maximum input current rating may damage CTs, but should not harm the meter.

None of these CTs measure DC current and the accuracy can be degraded in the presence of DC currents, as from half-wave rectified loads. The solid-core CTs are most susceptible to saturation due to DC currents.

WattNode meters should only be used with UL recognized current transformers, which are available from Continental Control Systems. Using non-approved transformers will invalidate the meter UL listing. The following sections list approved UL recognized current transformers.

Common CT Specifications

Type: voltage output, integral burden resistor

Output Voltage at Rated Current: 0.33333 Vac (one-third volt)

Standard CT Wire Length: 2.4 m (8 feet)

Optional CT Wire Length: up to 30 m (100 feet)

Split-Core CTs

Also called “opening” current transformers. These are UL recognized under UL file numbers E96927 or E325972: CTM-0360-**xxx**, CTS-0750-**xxx**, CTS-1250-**xxx**, CTS-2000-**xxx**, where **xxx** indicates the full scale current rating between 0005 and 1500 amps.

The accuracy of the split-core CTs are specified from 10% to 100% of rated AC current. The phase angle is specified at 50% of rated current (amps). Some low current split-core CTs have unspecified phase angle errors.

Model	Inside Diameter	Rated Amps (-xxx)	Accuracy / Phase Angle	Maximum Amps
CTM-0360-xxx	0.30" (7.5 mm)	5, 15, 30, 50, 70	±1% / <2°	100
CTS-0750-xxx	0.75" (19.0 mm)	5, 15, 30, 50	±1% / not spec.	200
CTS-0750-xxx	0.75" (19.0 mm)	70, 100, 150, 200	±1% / <2°	200
CTS-1250-xxx	1.25" (31.7 mm)	70, 100	±1% / not spec.	600
CTS-1250-xxx	1.25" (31.7 mm)	150, 200, 250, 300, 400, 600	±1% / <2°	600
CTS-2000-xxx	2.00" (50.8 mm)	600, 800, 1000, 1200, 1500	±1% / <2°	1500

Table 13: Split-core CTs

Split-Core Bus Bar CTs

These current transformers are referred to as “bus bar” CTs because they are available in larger and custom sizes appropriate for use with bus bars or multiple large conductors. These are UL recognized under UL file number E325972: CTB-**wwwXhhh-xxx**, where **www** and **hhh** indicate the width and height in inches, and **xxx** indicates the full scale current rating.

The accuracy of the split-core bus bar CTs is specified from 10% to 100% of rated current. The phase angle is specified at 50% of rated current (amps).

Model	Opening	Rated Amps	Accuracy / Phase Angle	Maximum Amps
CTB-1.5x3.5-0600	1.5" x 3.5" (38.1 mm x 88.9 mm)	600	±1.5% / <1.5°	750
CTB-4.0x4.0-0800	4.0" x 4.0" (101.6 mm x 101.6 mm)	800	±1.5% / <1.5°	1000
CTB-4.0x4.0-1200	4.0" x 4.0" (101.6 mm x 101.6mm)	1200	±1.5% / <1.5°	1500
CTB-4.0x4.0-2000	4.0" x 4.0" (101.6 mm x 101.6 mm)	2000	±1.5% / <1.5°	2500
CTB-4.5x4.0-3000	4.5" x 4.0" (114.3 mm x 101.6 mm)	3000	±1.5% / <1.5°	3750
CTB- wwwXhhh-xxxx	Custom (www by hhh inches)	xxxx	±1.5% / <1.5°	4000

Table 14: Split-core Bus Bar CTs

Solid-Core CTs

Also called “toroid” or “donut” current transformers. These are UL recognized under UL file number E96927: CTT-0750-100N, CTT-1250-400N, CTT-0300-030N, CTT-0500-060N, CTT-1000-200N, CTT-0300-005N, CTT-0300-015N, CTT-0500-050N, CTT-0500-030N, CTT-0500-015N, CTT-0750-070N, CTT-0750-050N, CTT-0750-030N, CTT-1000-150N, CTT-1000-100N, CTT-1000-070N, CTT-1000-050N, CTT-1250-300N, CTT-1250-250N, CTT-1250-200N, CTT-1250-150N, CTT-1250-100N, CTT-1250-070N.

The accuracy of the solid-core CTs is specified from 10% to 100% of rated current. The phase angle error is specified at 50% of rated current. The CT suffix **xxx** is the rated current. The "N" at the end of the part number indicates a nickel core material, which is the only core material available for our solid-core CTs.

Model	Inside Diameter	Rated Amps (-xxx)	Accuracy / Phase Angle	Maximum Amps
CTT-0300-xxxN	0.30" (7.6mm)	5, 15, 20, 30	±1% / <1°	30
CTT-0500-xxxN	0.50" (12.7mm)	15, 20, 30, 50, 60	±1% / <1°	60
CTT-0750-xxxN	0.75" (19.0mm)	30, 50, 70, 100	±1% / <1°	100
CTT-1000-xxxN	1.00" (25.4mm)	50, 70, 100, 150, 200	±1% / <1°	200
CTT-1250-xxxN	1.25" (31.7mm)	70, 100, 150, 200, 250, 300, 400	±1% / <1°	400

Table 15: Solid-core CTs

Warranty

All products sold by Continental Control Systems, LLC (CCS) are guaranteed against defects in material and workmanship for a period of five years from the original date of shipment. CCS's responsibility is limited to repair, replacement, or refund, any of which may be selected by CCS at its sole discretion. CCS reserves the right to substitute functionally equivalent new or serviceable used parts.

This warranty covers only defects arising under normal use and does not include malfunctions or failures resulting from: misuse, neglect, improper application, improper installation, water damage, acts of nature, lightning, product modifications, alterations or repairs by anyone other than CCS.

Except as set forth herein, CCS makes no warranties, expressed or implied, and CCS disclaims and negates all other warranties, including without limitation, implied warranties of merchantability and fitness for a particular purpose.

Limitation of Liability

In no event shall CCS be liable for any indirect, special, incidental, punitive or consequential damages of any kind or nature arising out of the sale or use of its products whether such liability is asserted on the basis of contract, tort or otherwise, including without limitation, lost profits, even if CCS has been advised of the possibility of such damages.

Customer acknowledges that CCS's aggregate liability to Customer relating to or arising out of the sale or use of CCS's products, whether such liability is asserted on the basis of contract, tort or otherwise, shall not exceed the purchase price paid by Customer for the products in respect of which damages are claimed. Customer specifically acknowledges that CCS's price for the products is based upon the limitations of CCS's liability set forth herein.